

# RangerWare

By



**POLARIS**<sup>®</sup>



## **Installation Instructions Ranger 500 Heater System**

Always install the Heater System first if possible

**NOTE:** If installing the Heater System with a windshield that has the Wiper System mounted on bottom of Windshield there is an optional vent kit available. (The defrost vent mounts in the center of the dash and the wiper motor could block the air flow.)

1. Lift and block the vehicle front and remove the driver side front wheel. Remove the driver side inner wheel well panel. (Photo 1)
2. Remove the center floor pan and seat.
3. Remove the switch blank from the instrument panel and drill a 3/8" hole for the control cable. (Photo 12) Remove the plastic rivets from the instrument panel and allow it to hang as shown. (Photo 2)
4. Loosen Battery and turn sideways or remove completely to allow extra work space. (Photo 3)
5. Use the template to cut out the dash and install the defrost vent. Tape the dash area to prevent scuff marks. (Photos 4 & 5) *If you are going to need the accessory vent kit do not install this defrost vent.*
6. Use a 2 1/16" or 2 1/8" hole saw to install the (2) 360degree vents where desired. Photos 6 & 7 show the suggested locations. Wherever you install them make sure there is adequate room for the vents and duct hose. Be careful not to damage any wiring under the dash. (Photos 6 & 7)
7. NOTE: To position heater, align the passenger side bracket with the steel dash support and the driver side bracket with the top center of the battery tray.

Open the hood and set the heater as close as possible to its final mounting position. Connect the duct hoses to the heater plenum (center outlet is for defrost) and route to the vents. Keep the hoses as short as possible. Secure the hoses with wire ties. (Photos 3 & 8)

8. Position the heater and fasten the passenger side bracket to the dash support using a #10 self tapping hex head screw. Fasten the driver side bracket to the center of the Battery tray using the Black Phillips head k-lath screws.
9. Use a 1 3/8" or 1 1/2" hole saw to drill a hole in the plastic tray in front of the battery and install the grommet. (Photo 9)

10. Remove the lower radiator hose at the radiator (driver side) and drain the coolant. Cut the hose 2” from the bend and install the tee. Route a piece of hose from the tee up thru the grommet (lube the grommet) to the filler on the upper heater core outlet. Use a piece of the spring to prevent kinking. Refasten the radiator hose and secure all connections with hose clamps. (Photos 9 & 10)
11. Note: Retain all parts for reinstallation. Remove the thermostat housing from the engine block. Install the adaptor, gaskets, thermostat and housing as shown in diagram “A” using the longer bolts supplied. (Photo 11)
12. Route a piece of hose from the adaptor down under the floor following the coolant hose on the driver side and up thru opening between the battery and terminal block to the valve on the lower portion of the heater core outlet. Secure the hose away from all moving parts with wire ties and tighten the hose clamps. (Photos 9 & 11)
13. Connect the negative (black) and the positive (red) wires to the terminal strip beside the battery (the top lug supplies key on power). Route the switch wires to thru the cutout and connect to the switch (Photo 13, back of switch) press the switch in place. (Photo 14)
14. Install the control cable thru the instrument panel and secure the nut. Route the cable under the dash support cross member and between the battery and heater. Make a loop in the control cable (allows the instrument panel to be removed). With the valve in the “off” position and the control knob pushed “in” place the control cable clamp on the valve and tighten the clamp. (Photos 12 & 14)
15. Reinstall the instrument panel.
16. With all the hose clamps tight and the heater valve “open” remove the radiator cap and the filler/bleeder cap. Fill the radiator with coolant and replace the cap. Slowly fill the system thru the filler / bleeder to allow air to exit. Replace the filler cap. ***CAUTION!!!! Coolant level is now above the radiator cap. Never open the radiator cap. Fill the system only thru the filler / bleeder and over flow reservoir. This information must be passed on to the customer and or vehicle owner.***
17. Start and run the vehicle for 2 minutes. With the engine off open the filler / bleeder and add coolant as needed. Repeat until coolant level remains full. **CHECK FOR LEAKS**
18. Start and run the vehicle. Operate the blower, warm air should blow from the vents within 2 minutes. The upper radiator hose should begin to warm within a few minutes (allow enough time for the engine

thermostat to open). If you do not have heat at the vents or upper radiator hose allow the engine to cool and check the coolant level. (Step 17)

19. Reassemble the vehicle.

**Ranger** *Ware*

*By*



**POLARIS®**

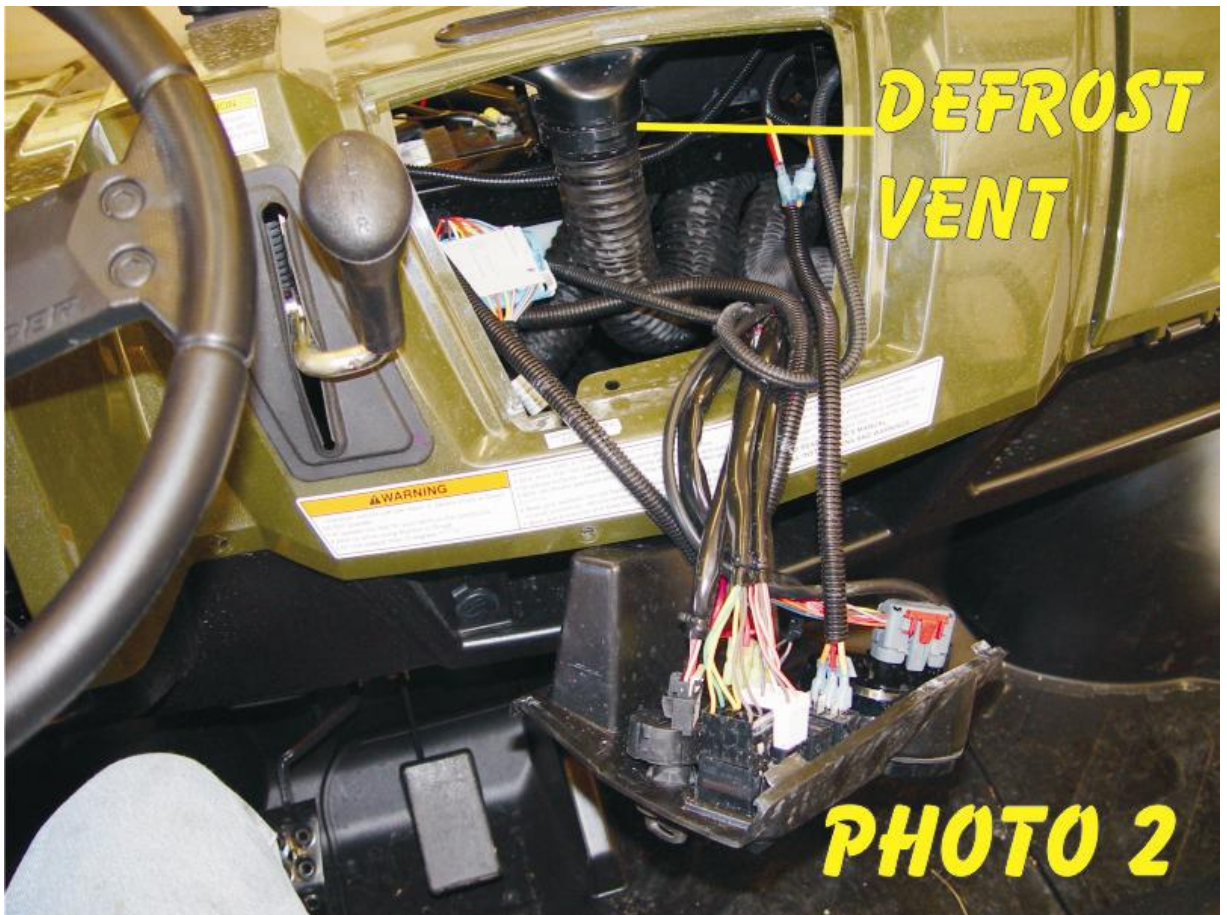
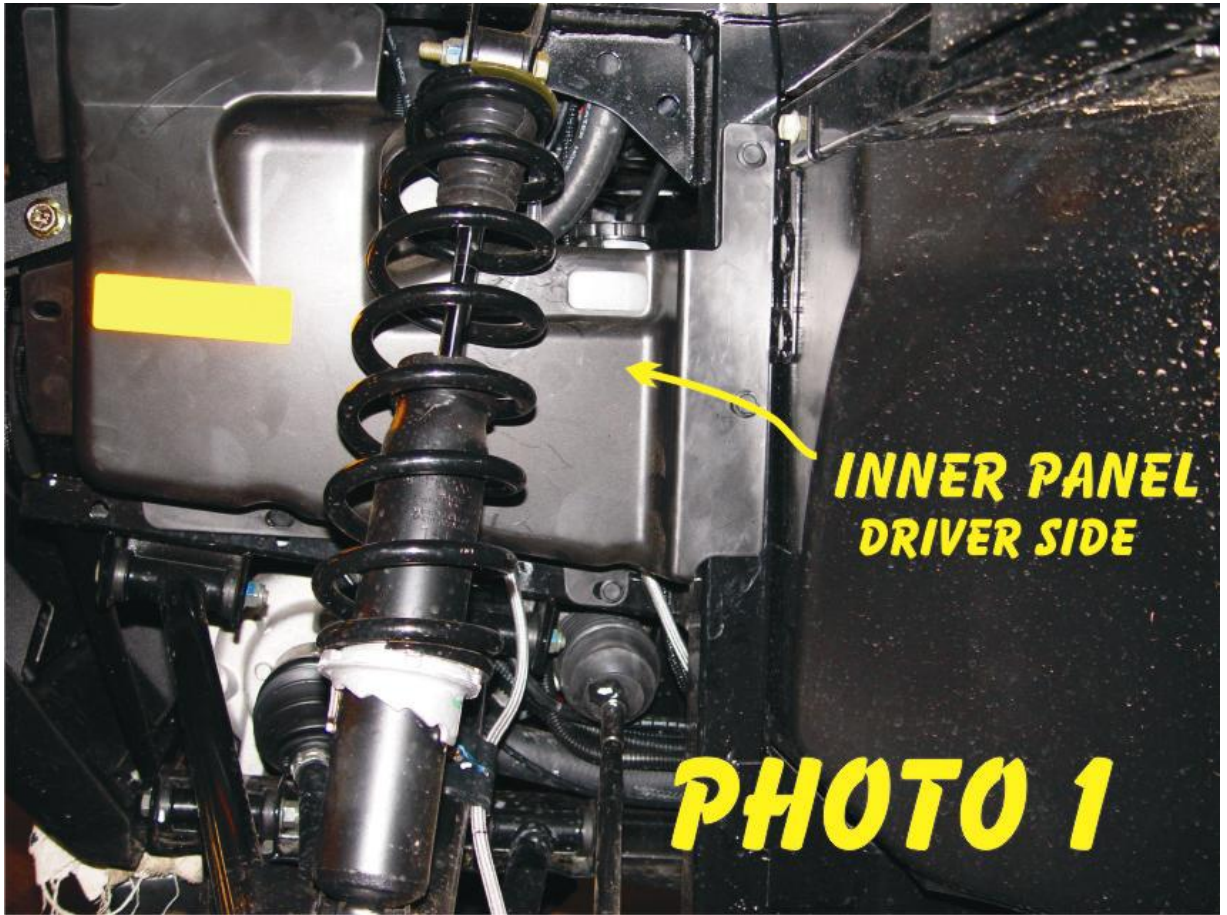

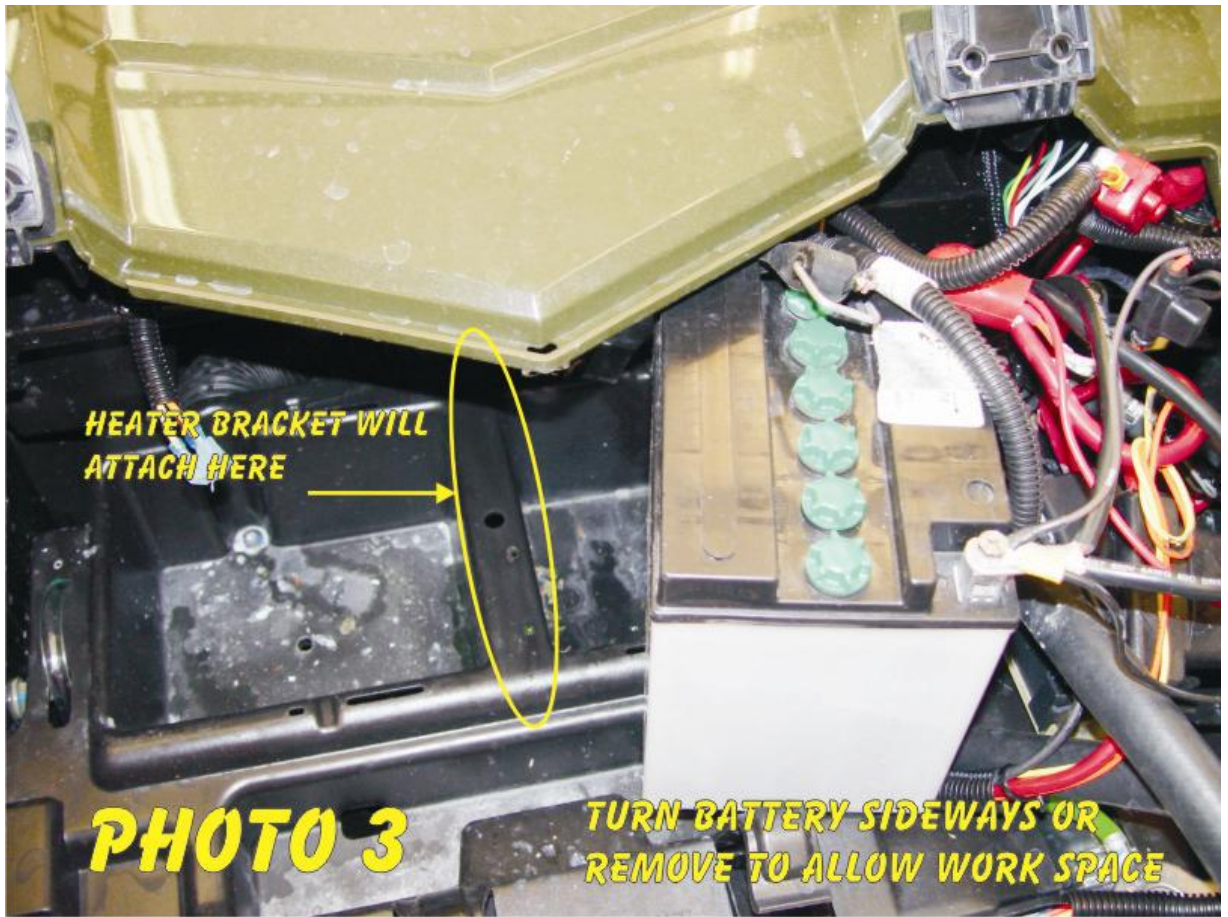

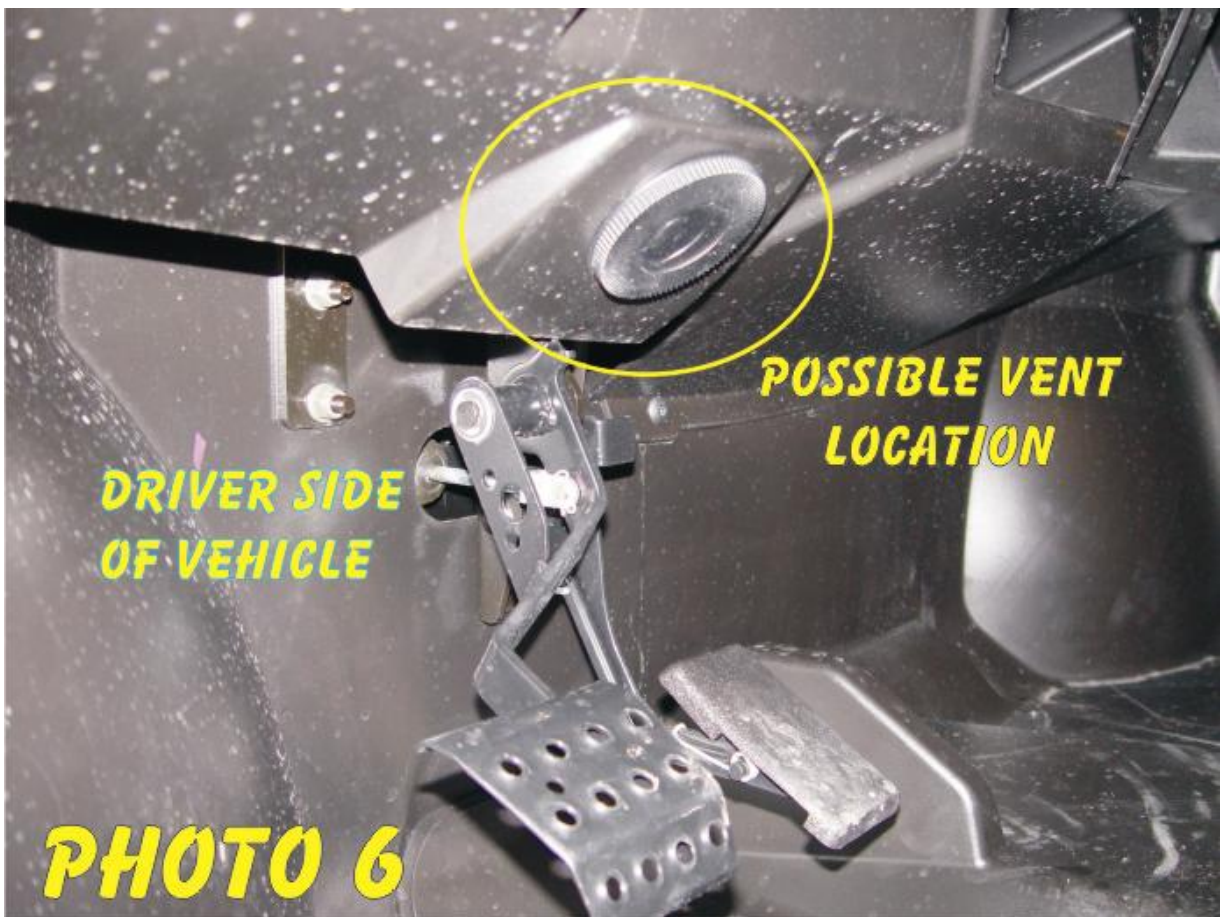
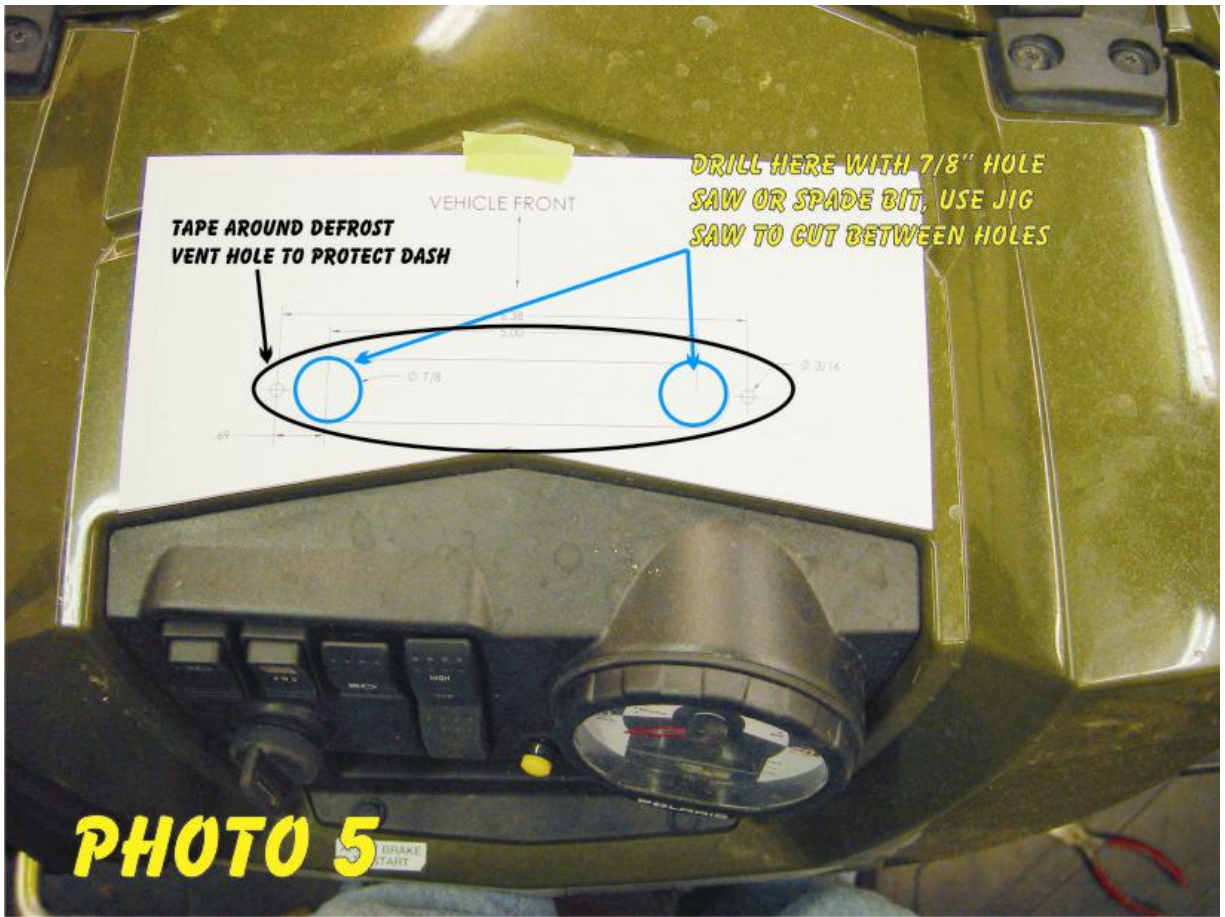

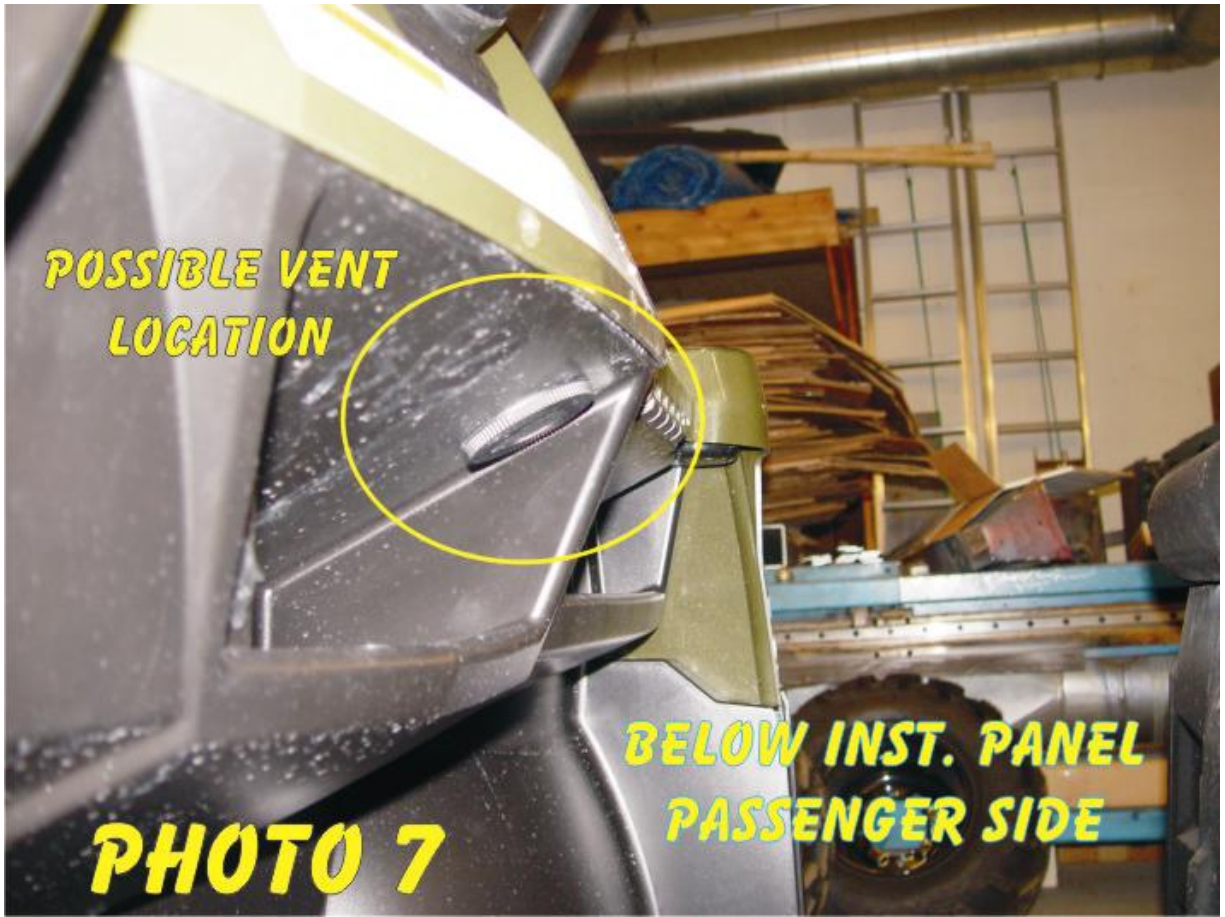

**POSSIBLE VENT  
LOCATION**

**BELOW INST. PANEL  
PASSENGER SIDE**

**PHOTO 7**

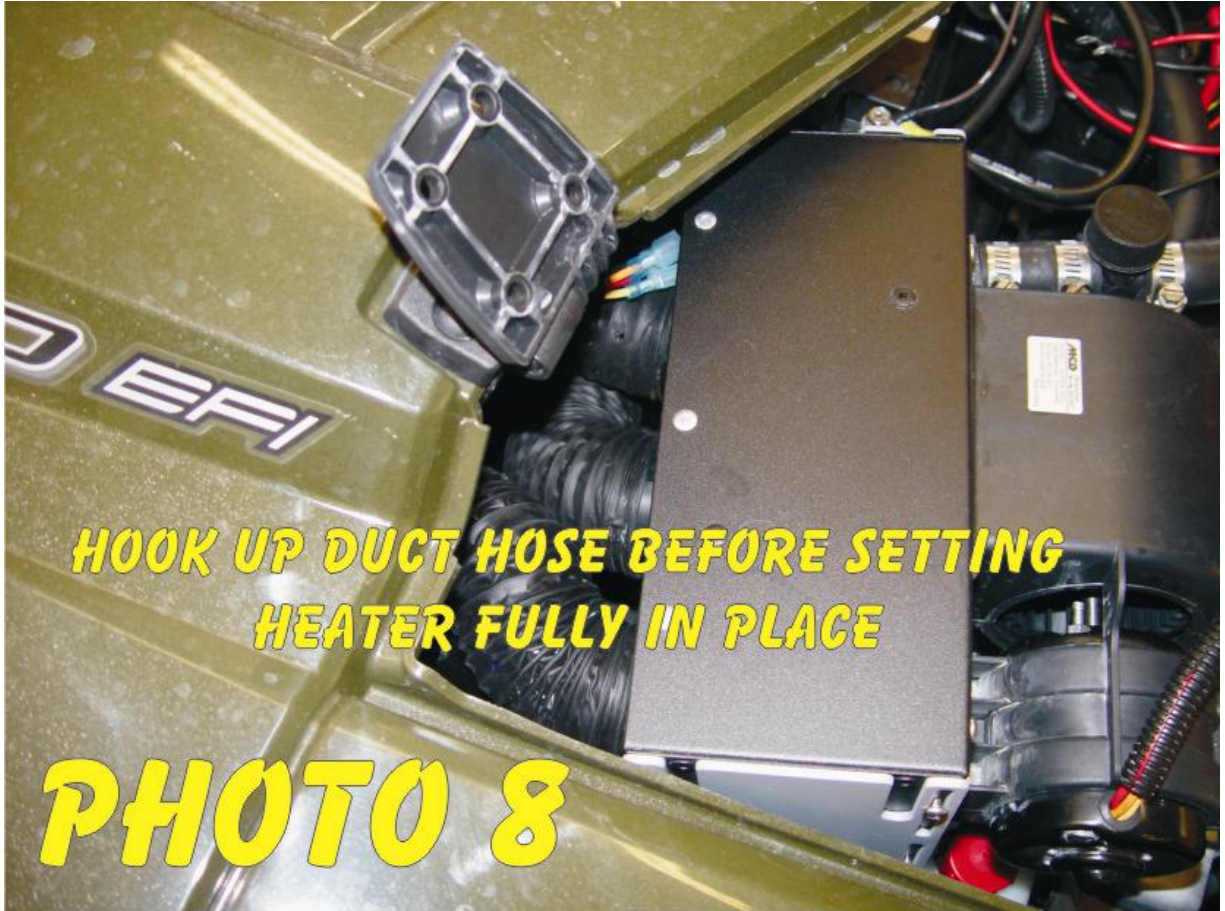

**HOOK UP DUCT HOSE BEFORE SETTING  
HEATER FULLY IN PLACE**

**PHOTO 8**

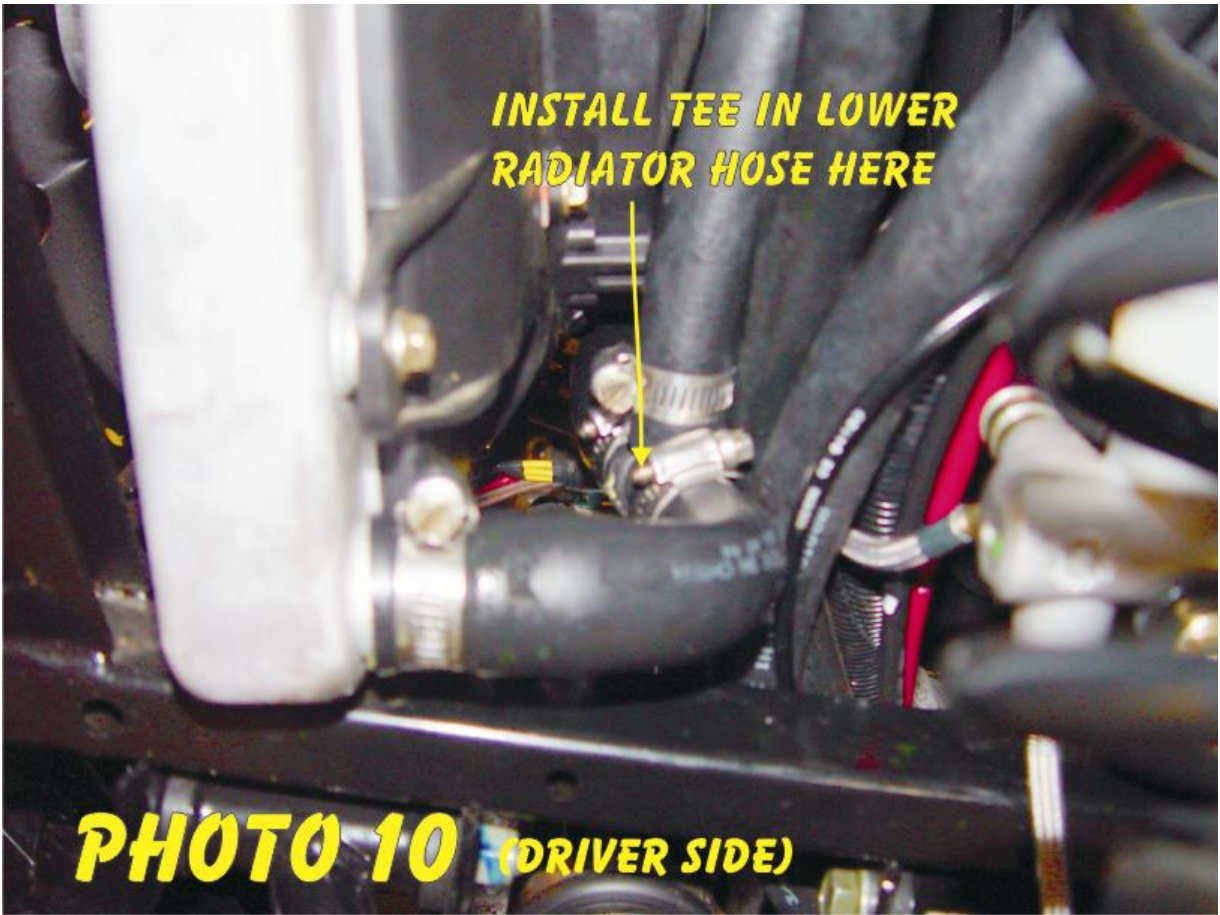
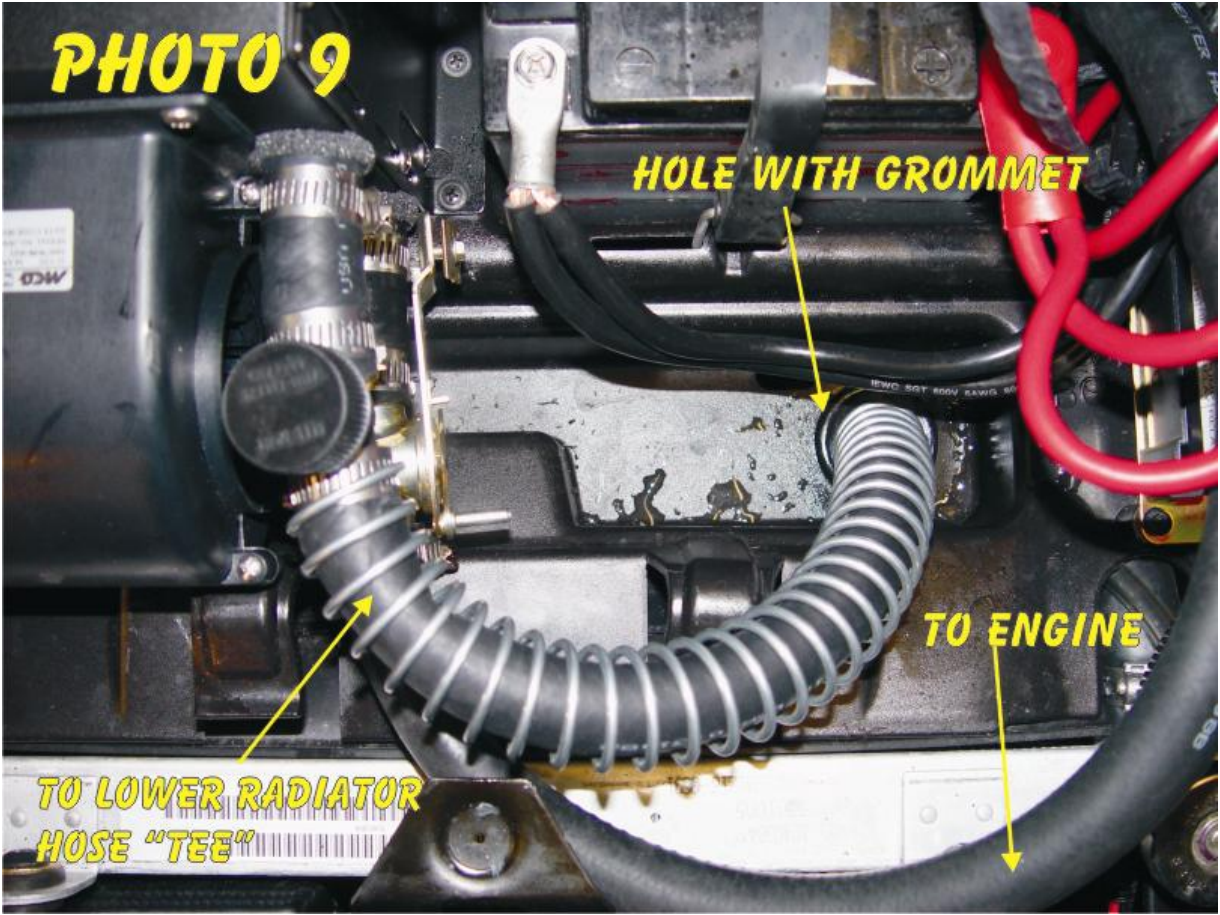

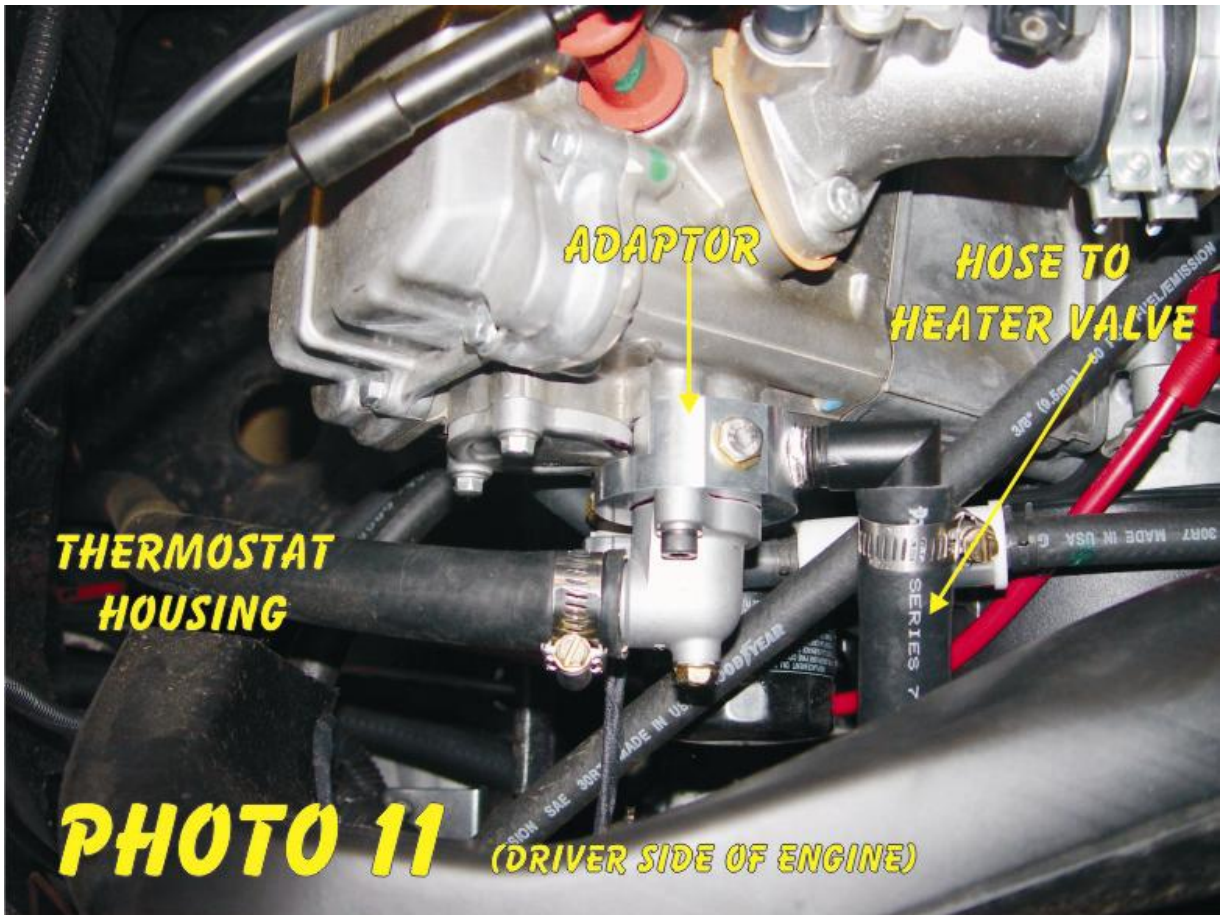

# Back of Switch

**PHOTO 13**

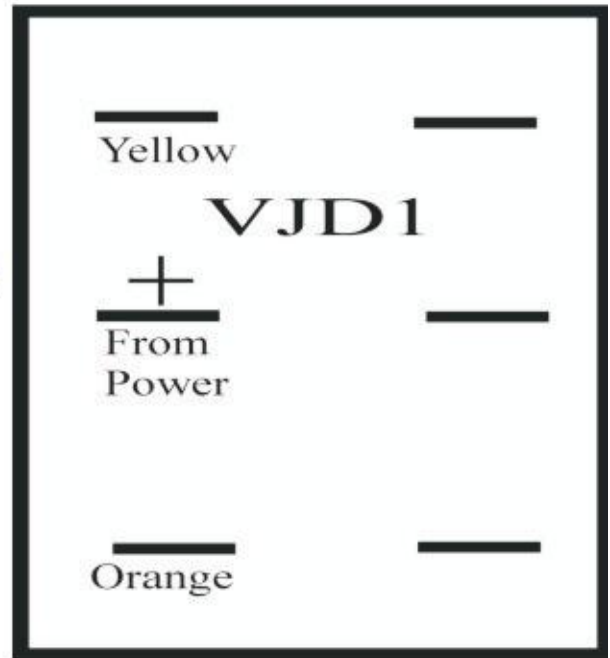

Red from heater is Medium and won't be used.  
Black from heater is Ground

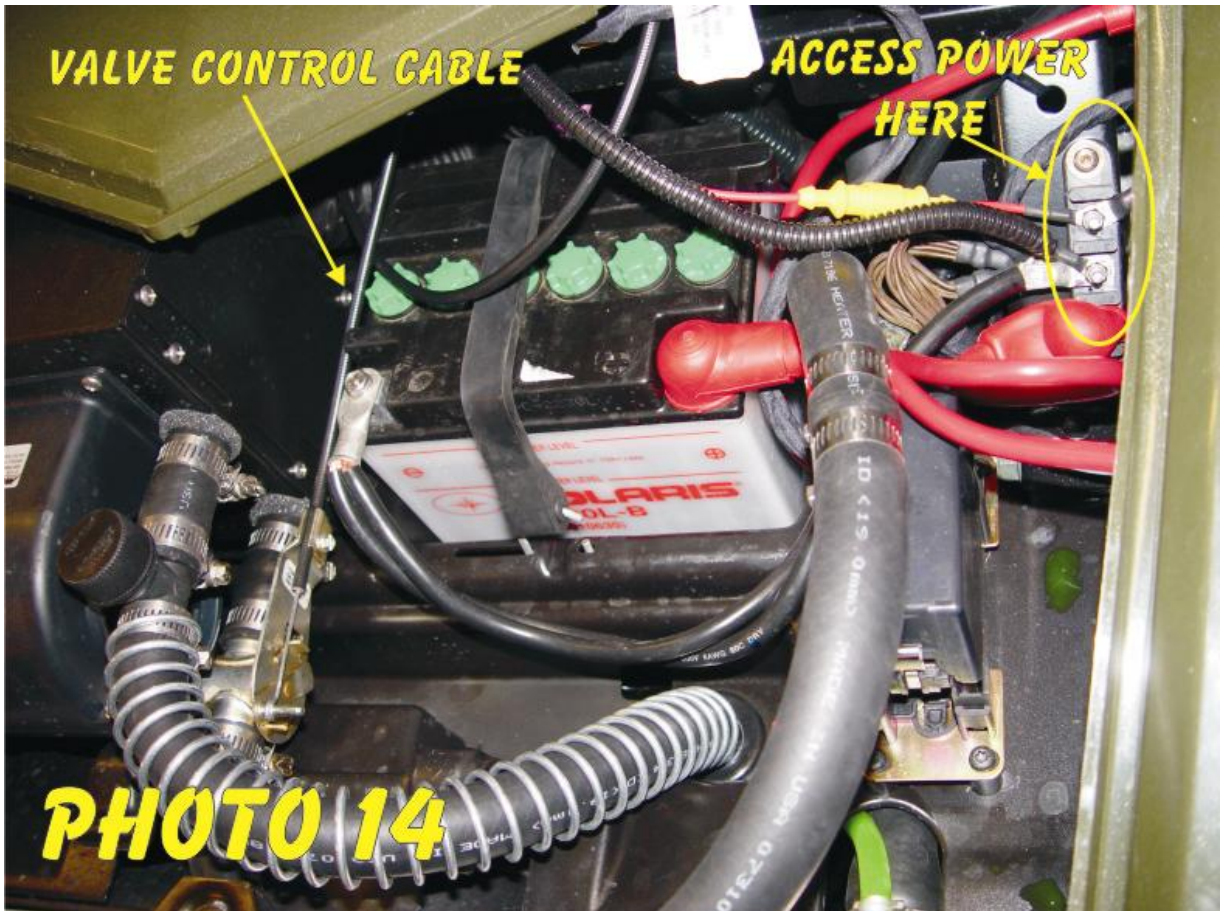

**PHOTO 14**

09 RANGER 500 & 700 HEATER HOSE ROUTING SCHEMATIC

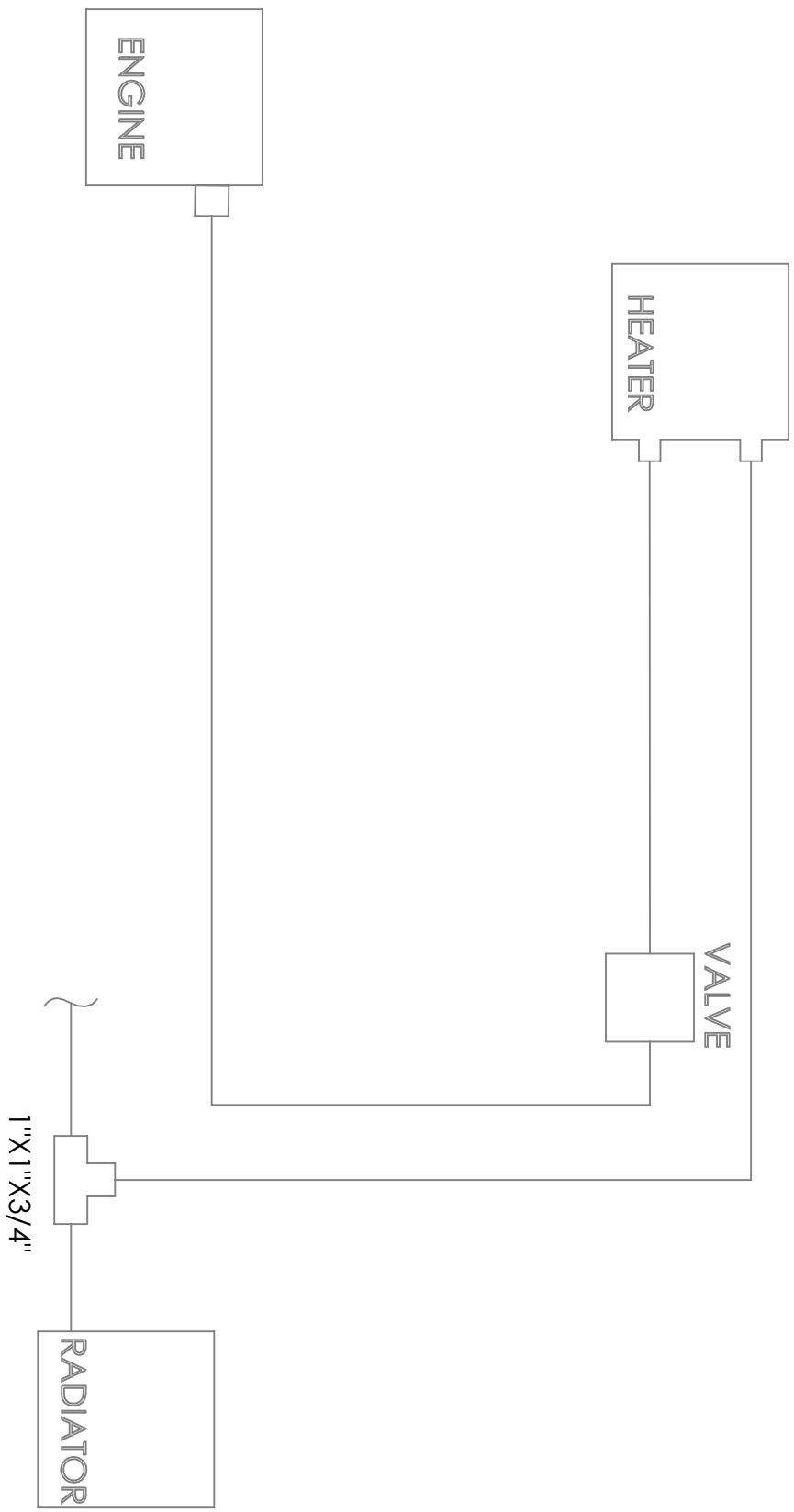

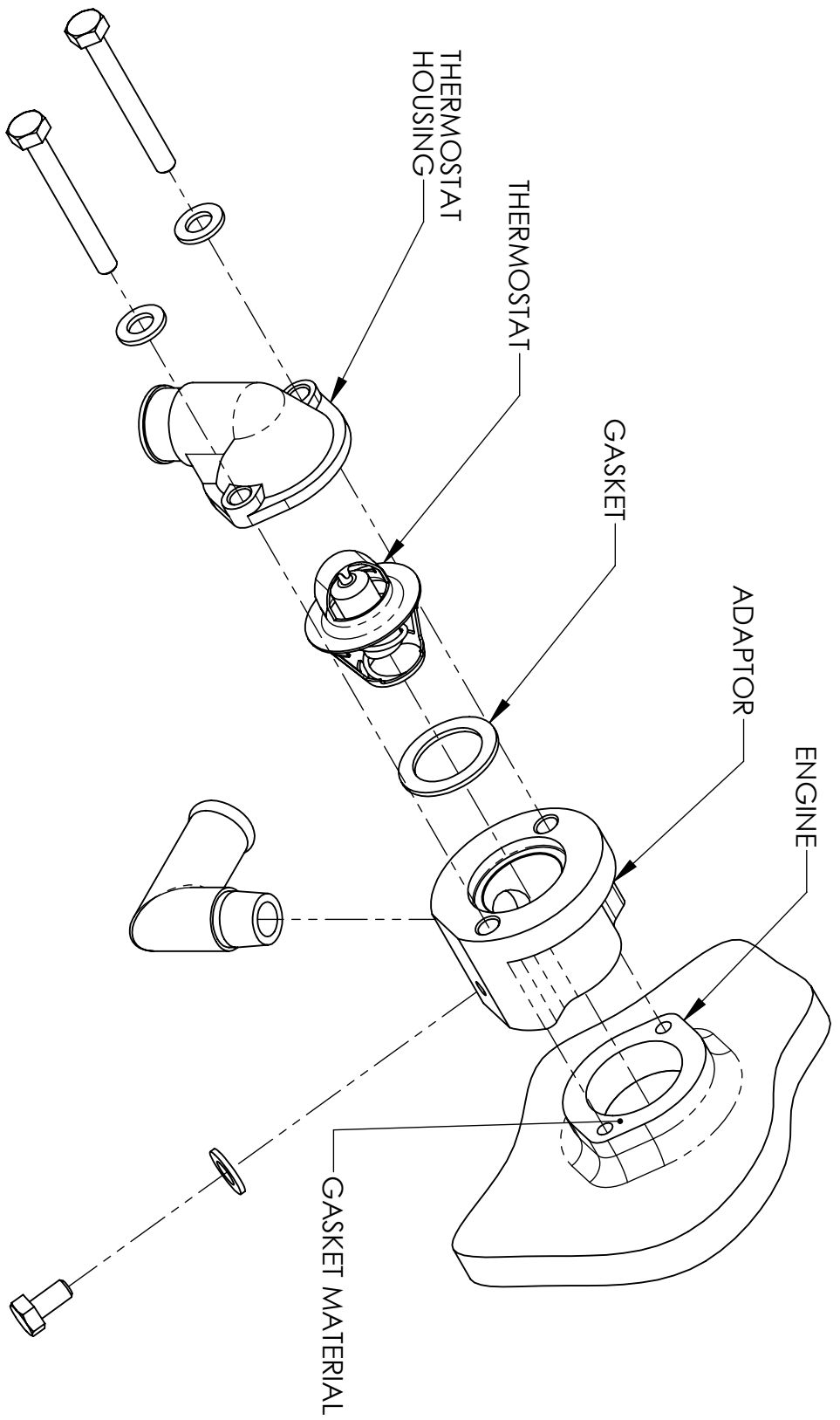

VEHICLE  
FRONT

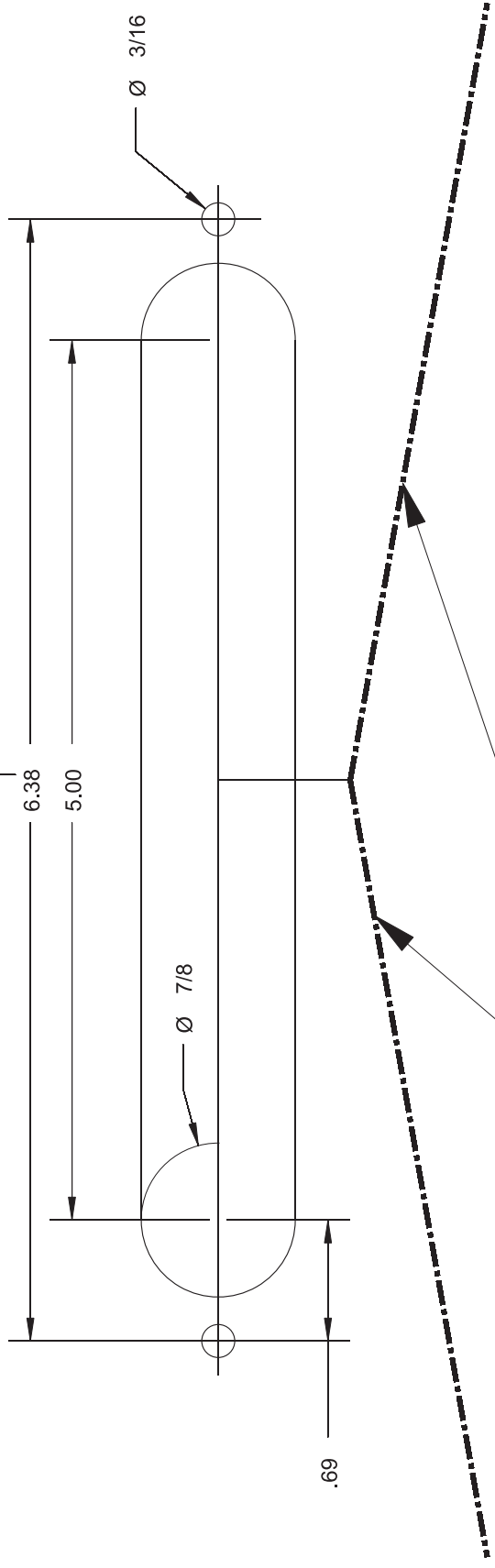

Cut out along line. Line up with matching contour on dash above instrument panel for defrost cut out.