

Group 10

Miscellaneous

Cap Screws, Nuts & Washers

Order number	Size	Description
7/16FW	7/16"	Washer, flat, zinc
7/16LW	7/16	Washer, lock, zinc
7/16-14NUT	7/16-14	Nut, hex, zinc, coarse thread
7/16-14X1-1/2	7/16-14 x 1-1/2	Cap screw, hex head, zinc
5/8FW	5/8"	Washer, flat, zinc
M6FN	M6	Nut, flange, zinc
M6LW	M6	Washer, lock, zinc
M6X18.7FW	M6 x 18.7 OD	Washer, fender, zinc
M6X20	M6 x 20	Cap screw, hex head, zinc
M6X25	M6 x 25	Cap screw, hex head, zinc
M8X24FW	M8 x 24 OD	Washer, fender, zinc
M8LW	M8	Washer, lock, zinc
M8NUT	M8	Nut, hex, zinc
M8X20	M8 x 20	Cap screw, hex head, zinc
M8X25	M8 x 25	Cap screw, hex head, zinc
M8X60	M8 x 60	Cap screw, hex head, zinc
M10X31FW	M10 x 31 OD	Washer, fender, zinc
M10LW	M10	Washer, lock, zinc
M10NUT	M10	Nut, hex, zinc
M10X30	M10 x 30	Cap screw, hex head, zinc
M12X36.5FW	M12 x 36.5 OD	Washer, fender, zinc
M12LW	M12	Washer, lock, zinc
M12NUT	M12	Nut, hex, zinc
M12NUT-Fine thread	M12	Nut, fine thread, hex, zinc
M12X30	M12 x 30	Cap screw, hex head, zinc
M12X45	M12 x 45	Cap screw, hex head, zinc
M12X55	M12 x 55	Cap screw, hex head, zinc
M12X100	M12 x 100	Cap screw, hex head, zinc
M14LW	M14	Washer, lock, zinc
M14NUT	M14	Nut, hex, zinc, coarse thread
M14X21	M14 x 21 *	Cap screw, hex head, fine thread, zinc * Front wheel lug bolt – 1500D Replaces 194191-14851
M14X25	M14 x 25 *	Cap screw, hex head, coarse thread, zinc *Front wheel lug bolt – 1500 Replaces 26116-140252
M16LW	M16	Washer, lock, zinc
M16NUT	M16	Nut, hex, zinc
M16X30	M16 x 30	Cap screw, hex head, zinc

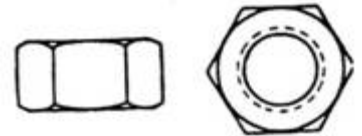



HH-518 Hydraulic hose assembly, 1/2" – 2 wire hose
18" long with solid male fittings each end



HH-524 Hydraulic hose assembly, 1/2" – 2 wire hose
24" long with solid male fittings each end

HH-536 Hydraulic hose assembly, 1/2" – 2 wire hose
36" long with solid male fittings each end

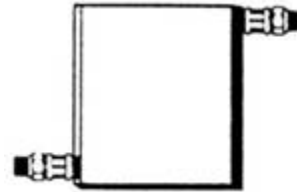

HH-548 Hydraulic hose assembly, 1/2" – 2 wire hose
48" long with solid male fittings each end

HH-560 Hydraulic hose assembly, 1/2" – 2 wire hose
60" long with solid male fittings each end

HH-572 Hydraulic hose assembly, 1/2" – 2 wire hose
72" long with solid male fittings each end

PC-12 Coupler, 1/2" female NPT



HA-12 Coupler, 1/2" male NPT



HA-90 Adaptor – 90°, 1/2" NPT female swivel X
3/4-16 ORB male

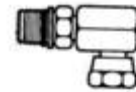

HA-88 Adaptor, swivel 3/4-16 ORB male X
1/2" NPT female swivel



P-12 Plug – 1/2" NPT (5 per bag)

PO-1543 Super Strength Penetrating Oil – 20oz. can, 15oz. fill

- Frees corroded & rusted parts
- Fast acting
- Safe on all metals & alloys

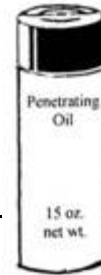

SP-Green Spray paint, **SPRUCE GREEN** for frame and undercarriage touch up. 12oz. net weight

SP-Red Spray paint, **RED** for hood and fender touch up. 12oz. net weight.

GP-Red Gallon can, **RED**

SP-White Spray paint, **WHITE** for side panel, grille and wheel touch up. 12oz. net weight.

GP-White Gallon can, **WHITE**

SP-Primer Spray paint, **LIGHT GRAY PRIMER**. 12oz. net weight.

SP-Black Spray paint, **GLOSS BLACK**. 12oz. net weight.



Decal Sets for Yanmar

Black letters and numbers
on ivory background

DS-0000	Nonspecific decal set – YANMAR DIESEL	
DS-1300	Decal set for YM1300	DS-1300D Decal set for YM1300D
DS-1401	Decal set for YM1401	
DS-1500	Decal set for YM1500	
DS-1500D	Decal set for YM1500D	
DS-1601	Decal set for YM1601	
DS-1601D	Decal set for YM1601D	
DS-1610	Decal set for YM1610	
DS-1610D	Decal set for YM1610D	
DS-1700	Decal set for YM1700	
DS-2000	Decal set for YM2000	
DS-2210	Decal set for YM2210	
DS-2210D	Decal set for YM2210D	
DS-2500	Decal set for YM2500	
DS-2610	Decal set for YM2610	
DS-3000	Decal set for YM3000	
DS-3110	Decal set for YM3110	

- GF-6** Grease fitting, 6mm, straight
- GF-10** Grease fitting, 10 mm, straight
- DP-110** Drain plug – M 10 Repl. 129350-49120
- DP-112** Drain plug – M 12, 1401 oil plug
Repl. 23491-120002 (old # 124060-01640)
- OR-112** Oring seal for DP-110 & DP-112 Repl. 24311-000140
- DP-114** Drain plug – M 14 Repl. 23491-140002
- OR-160** Oring seal for DP-114
- DP-116** Plug, oil pan drain F series Repl. 105425-01690
- DPW-116** Washer, drain plug F series Repl. 22190-160002



Weight
Suitcase type
for front bumper

- SW-42** Suit case weight for front bumper
Approx. 42 lbs. (***value cannot be counted toward prepaid freight***)
Oct. 2004

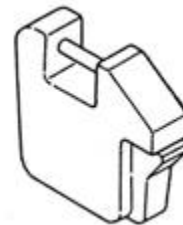

81878 Permatex Copper RTV silicone, use for 4 cylinder, turbocharged or high performance engines, exhaust manifolds/ headers, valve covers, oil pans, timing covers, water pumps. 3 oz tube.



80016 Permatex Form-A-Gasket #2, Temperature range -65° F to 400° F, 3oz tube.



80646 Permatex Gasket Remover, 16 oz aerosol can.



81158 Permatex BLACK Silicone Adhesive Sealant, 3 oz tube.



82180 Permatex ULTRA BLACK gasket maker, use for valve covers, oil pans, intake, manifold end seals, timing covers, transmission pans. -75° F to 600° F.



81160 Permatex RED Hi-Temp RTV, 3 oz tube.



Finishing Mower Blades

- MB-48** Blade for 4' mowers: Sitrex SM/120L Repl. 100.064
 Tecma FM 120 Repl. 636001
 Caroni TC480N Repl. 480 077 00
- MB-60** Blade for 5' mowers: Sitrex SM/150L Repl. 100.065
 Tecma FM 150 Repl. 636002
 Caroni TC590N Repl. 590 062 00
- MB-72** Blade for 6' mowers: Sitrex SM/180L Repl. 100.066
 Tecma FM 180 Repl. 636003
 Caroni TC710N Repl. 710 010 00
- M18LN** Blade bolt nut Repl. 600.746

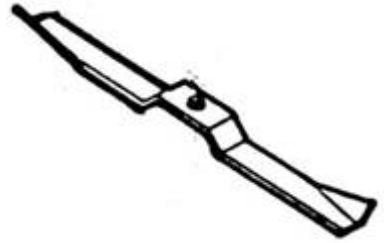

Tail wheel fork & spacers

- TWF-100** Tail wheel fork, 7-1/2" spindle to bottom of pin (A) hole, 25mm dia. Repl. Sitrex 100.020
- P-794** 1/4" lynch pin, 100 per bag (B)
- P-7915** 5/16" lynch pin, 100 per bag (B)
- B-116** Height adj. bushing for tail wheel fork (C)
 2mm / 1/16" Repl. Sitrex 100.042
- B-14** Same as above, 6mm / 1/4" (C)
 Repl. Sitrex 100.043
- B-12** Same as above, 12mm / 1/2" (C)
 Repl. Sitrex 100.044
- B-1** Same as above, 25mm / 1" (C)
 Repl. Sitrex 100.045
- B-114** Same as above, 32mm / 1-1/4" (C)
 Repl. Sitrex 100.046
- AB-156** Wheel bolt for TWF-100 (D)
 Repl. Sitrex 600.156
- AN-77** Lock nut for wheel bolt Repl. Sitrex 600.077 (E)

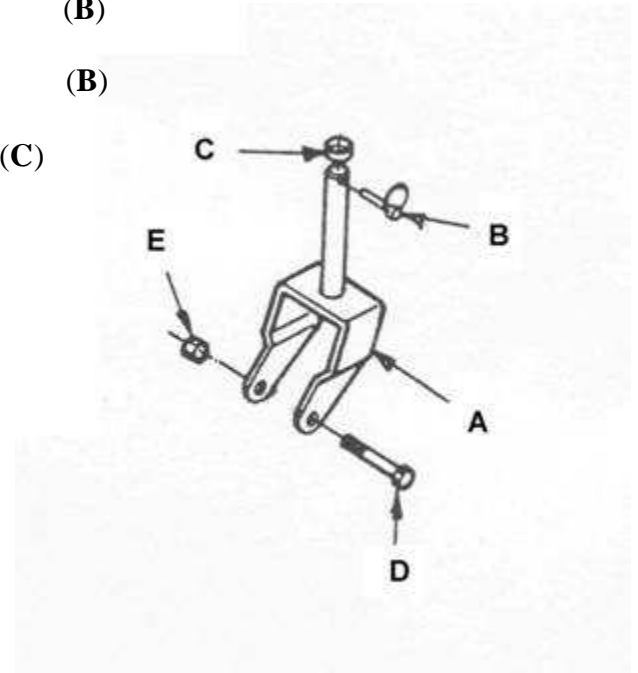

Tail wheel parts

- WS-6** Wheel spacer (2 req'd) Repl. Sitrex 100.006 (1)
- WB-8** Wheel bushing Repl. Sitrex 100.008 (2)
- 600.165** Wheel for Sitrex and others (3)
- P-794** ¼" lynch pin, 100 per bag (9)
- P-7915** 5/16" lynch pin, 100 per bag (9)
- AB-156** Wheel bolt for TWF-100 (4)
Repl. Sitrex 600.156
- AN-77** Lock nut for wheel bolt Repl. Sitrex 600.077 (5)

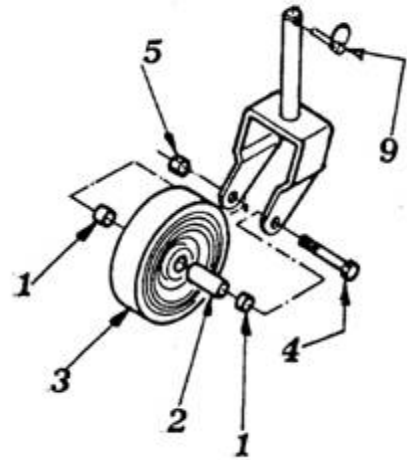

Belt for Finishing Mower

- MB-51** Belt for 4' Finish Mower
Repl. Sitrex 600.141
- MB-68** Belt for 5' Finish Mower
Repl. Sitrex 600.139
- MB-74** Belt for 6' Finish Mower
Repl. Sitrex 600.140

