

**Thank you for taking a look at Thermo King PG Parts™.** We are proud to offer you a wide assortment of Thermo King-quality parts for your Carrier® units. You can be assured that the Thermo King tradition of engineering excellence has been built into each and every PG Part.

All PG Parts are engineered to meet or exceed OEM specifications and have a nationwide warranty backed by over 200 dealers and service centers. We are happy to provide our customers a high quality, competitive and convenient alternative to Carrier aftermarket parts.

## Table of Contents:

<b>ENGINES.....</b>	<b>2-30</b>
Engine Cross Reference .....	2
Remanufactured Engines .....	4
Engine Overhaul Kits .....	7
Filters .....	11
Hoses .....	16
Injectors .....	21
Water Pumps .....	25
Starters .....	26
<b>COMPRESSOR.....</b>	<b>31-41</b>
Remanufactured Compressors .....	31
<b>REFRIGERATION .....</b>	<b>43-51</b>
Coils .....	43
Driers .....	43
Solenoids .....	45
Valves .....	47
Vibrasorbers .....	50
<b>ELECTRICAL .....</b>	<b>53-68</b>
Alternators .....	53
Switches .....	64
<b>DRIVE.....</b>	<b>69-77</b>
Belts .....	70
Clutches .....	73
Pulleys .....	76
Fan Shafts .....	77
<b>STRUCTURAL.....</b>	<b>79-94</b>
Replacement Doors .....	83
<b>BUS .....</b>	<b>85-89</b>
<b>CONTAINER .....</b>	<b>91-108</b>
<b>WARRANTY .....</b>	<b>109</b>
<b>UNIT REFERENCE CHART .....</b>	<b>110-112</b>
<b>ALPHA NUMERIC INDEX WITH APPLICATION DATA .....</b>	<b>i-xxix</b>

# Truck & Trailer Parts – ENGINE

ENGINE

Unit Name	Unit Model	Refrigerant	Carrier Engine #	OEM Engine #	Comp	Option	Volt
<b>Eagle</b>	NDB-402	12	Perkins	4/108	05G41		
	NDB-406	12	Mitsubishi	4DQ50	05G41		
<b>Eagle Plus</b>	NDB-401	12	CT4-134DI	V2203DI	05G41		
	NDB-405	12	CT4-114IDI	V1902IDI	05G41		
	NDB-408	12	CT4-114DI	V1902DI	05G41		
	NDB-409	12	CT4-134TV	V2203TV	05G41		
	NDB-461	500	CT4-134DI	V2203DI	05G41		
	NDB-465	500	CT4-114IDI	V1902IDI	05G41		
	NDB-468	500	CT4-114DI	V1902DI	05G41		
	NDB-469	500	CT4-134TV	V2203TV	05G41		
	NDB-491	502	CT4-134DI	V2203DI	05G41		
	NDB-495	502	CT4-114IDI	V1902IDI	05G41		
	NDB-498	502	CT4-114DI	V1902DI	05G41		
	NDB-499	502	CT4-134TV	V2203TV	05G41		
	NDS-405N2	12	CT4-114IDI	V1902IDI	05G41	Standby	230
	NDS-405N6	12	CT4-114IDI	V1902IDI	05G41	Standby	460
	NDS-408N2	12	CT4-114DI	V1902DI	05G41	Standby	230
NDS-408N6	12	CT4-114DI	V1902DI	05G41	Standby	460	
<b>Euro-Phoenix</b>	NDA	12	CT4-114IDI	V1902IDI	05G41	Standby	230/380
<b>Euro-Phoenix Plus</b>	NDM	12	CT4-114IDI	V1902IDI	05G41	Standby	230/380
<b>Extra</b>	NDA-93E	404A	CT4-114TV	V1903TV	05G37	Standby	230
	NDA-94E	22	CT4-114TV	V1903TV	05G37		
	NDA-94E	22	CT4-114TV	V1903TV	05G37	Standby	230
	NDM-93E	404A	CT4-114TV	V1903TV	05G37	Standby	230
	NDM-93E Euro	404A	CT4-114TV	V1903TV	05G37	Standby	380
<b>Genesis TM1000</b>	NDM-94E	22	CT4-114TV	V1903TV	05G37	Standby	230
	NDM-94E Euro	22	CT4-114TV	V1903TV	05G37	Standby	380
<b>Genesis TM900</b>	NDA93__W	404A	CT4-134DI/TV	V2203DI/V2203TV	05G41	Multi-Temp	
	NDA94__W	22	CT4-134DI/TV	V2203DI/V2203TV	05G41	Multi-Temp	
	NDA93__N	404A	CT4-134DI/TV	V2203DI/V2203TV	05G37	Multi-Temp	
<b>Maxima</b>	NDA94__N	22	CT4-134DI/TV	V2203DI/V2203TV	05G37	Multi-Temp	
	8000201	22	CT4-91TV	V1505	05K24	Standby	380
	8000268	22	CT4-91TV	V1505	05K24		
	8000282	22	CT4-91TV	V1505	05K24	Standby	380
	8000285	22	CT4-91TV	V1505	05K24	Standby	380
	8000286	22	CT4-91TV	V1505	05K24		
	8000307	22	CT4-91TV	V1505	05K24		
	8000308	22	CT4-91TV	V1505	05K24	Standby	380
8000309	22	CT4-91TV	V1505	05K24			
<b>Maxima 2 (Continued Next Page)</b>	8001193	22	CT4-91TV	V1505	05K24	Standby	380
	8001194	404A	CT4-91TV	V1505	05K24	Standby	380
	8001216	22	CT4-91TV	V1505	05K24	Standby	380
	8001217	404A	CT4-91TV	V1505	05K24	Standby	380
	8001218	22	CT4-91TV	V1505	05K24	Standby	380
	8001219	22	CT4-91TV	V1505	05K24		
	8001220	22	CT4-91TV	V1505	05K24		

## Truck & Trailer Parts – ENGINE

ENGINE

Unit Name	Unit Model	Refrigerant	Carrier Engine #	OEM Engine #	Comp	Option	Volt
<b>(Maxima 2 Continued)</b>	8001221	404A	CT4-91TV	V1505	05K24	Standby	380
	8001222	404A	CT4-91TV	V1505	05K24	Stop/start	
	8001223	404A	CT4-91TV	V1505	05K24		
	8001224	22	CT4-91TV	V1505	05K24		
	8001225	404A	CT4-91TV	V1505	05K24		
<b>Optima</b>	NDA-93B	404A	CT4-91TV	V1505	05K24		
	NDA-94B	22	CT4-91TV	V1505	05K24		
<b>Phoenix Advantage</b>	NDA-74	22	CT4-134DI/TV	V1902IDI/V2203TV	05G41		
	NDA-76	12/500/502	CT4-114/134DI	V1902IDI/V2203DI	05G41		
	NDA-79	502	CT4-114/134DI	V1902IDI/V2203DI	05G41		
<b>Phoenix Ultra</b>	NDA-93A	404A	CT4-134TV	V2203TV	05G41		
	NDA-93A Euro	404A	CT4-134TV	V2203TV	05G37	Standby	380
	NDA-94	22	CT4-134DI	V2203TV	05G41		
	NDA-94A	22	CT4-134TV	V2203TV	05G41		
	NDA-94A Euro	22	CT4-134TV	V2203TV	05G37	Standby	380
	NDA-94A-M2/3	22	CT4-134TV	V2203TV	05G41	Multi-Temp	
	NDM-94A	22	CT4-134TV	V2203TV	05G37	Standby	230
	NDM-94A Euro	22	CT4-134TV	V2203TV	05G37	Standby	380
<b>Phoenix Ultra XL</b>	NDA-93D	404A	CT4-134DI	V2203DI	05G41		
	NDA-93D Euro	404A	CT4-134DI	V2203DI	05G37	Standby	380
	NDA-94D	22	CT4-134DI	V2203DI	05G41		
	NDM-94D	22	CT4-134DI	V2203DI	05G37	Standby	230
	NDM-94D Euro	22	CT4-134DI	V2203DI	05G37	Standby	380
<b>Phoenix Xtra</b>	NDA-84	22	CT4-114/134DI	V1902IDI/V2203DI	05G41		
	NDA-85	502	CT4-134TV	V2203TV	05G41		
	NDA-89	502	CT4-114/134DI	V1902IDI/V2203DI	05G41		
<b>Supra 422</b>	TBS-10	22	CT2-29TV	Z482	EF210		
	TDS-10	22	CT2-29TV	Z482	EF210	Standby	
<b>Supra 622</b>	TDB-17	22	CT3-44TV	D722	05K12		
	TDS-17	22	CT3-44TV	D722	05K12	Standby	
<b>Supra 722</b>	TDB-19	22	CT3-44TV	D722	05K12		
	TDS-19	22	CT3-44TV	D722	05K12	Standby	
<b>Supra 922</b>	TDB 36	22	CT3-69TV	D1105	05G37		
	TDS 36	22	CT3-69TV	D1105	05G37	Standby	460
<b>Supra 944</b>	TDB 32	404A	CT3-69TV	D1105	05G37		
	TDS 32	404A	CT3-69TV	D1105	05G37	Standby	460
<b>Thunderbird</b>	NDF-425N2	12	CT4-114/134DI	V1902IDI/V2203DI	05G41	Standby	230
	NDF-425N6	12	CT4-114/134DI	V1902IDI/V2203DI	05G41	Standby	460
	NDJ-42	12	CT4-114/134DI	V1902IDI/V2203DI	05G41		
	NDJ-44	22	CT4-114/134DI	V1902IDI/V2203DI	05G41		
	NDJ-46	500	CT4-114/134DI	V1902IDI/V2203DI	05G41		
	NDJ-49	502	CT4-114/134DI	V1902IDI/V2203DI	05G41		
<b>Ultima</b>	NDX-93D	404A	CT4-134DI	V2203DI	05G41		
<b>Vector</b>	8001334	404A	CT4-134TV	V2203TV	06D		

# NOW FEATURING

## Remanufactured PG Parts™ Engines for your Carrier® units – 134TV & 134DI

**OUR PG PARTS ENGINES AND ENGINE PARTS ARE FOR PRE-TIER I ENGINES (PRE 1999)**

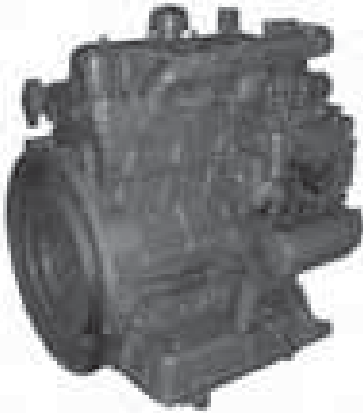

**Engine, Reman (134TV) Ultra**

Order Part #: P-26-50004-00RM  
(Replaces Carrier #: 26-50004-00RM)

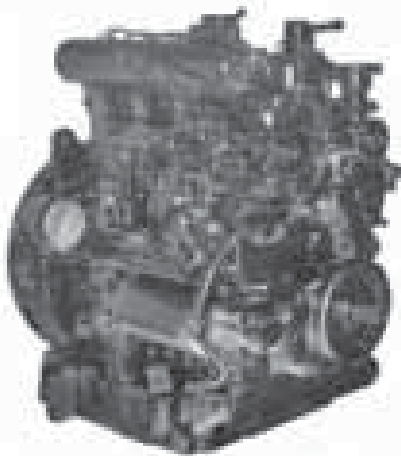

**Engine, Reman (134DI) Ultima**

Order Part #: P-26-50015-00RM  
(Replaces Carrier #: 26-50015-00RM)

✓ **We replace the following parts with new components:**

- Water Pump
- Oil Pump
- Bearings
- Pistons and Rings
- Glow Plugs
- Gaskets
- Seals

✓ **Engine Specifications Match OEM Standards**

✓ **Stocked and Shipped from our Minneapolis Warehouse**

✓ **Each Engine is Dyno Tested:**

- Computer controls ensure that each engine Dyno Test is conducted under standard, repeatable settings
- Maximum torque and horsepower tested
- Black light leak tested with dyed oil and fuel

### Carrier Engine Reference

TIER	YEAR STARTED	SERIAL # BEGINS
Tier I	1999	X
Tier II	2004	4A
Tier 4i	2008	8A

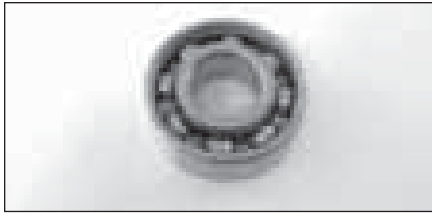

**Bearing, Fuel Cam (Rear)  
91TV & 69TV**

Order Part #: P-25-15166-00  
(Replaces Carrier #: 25-15166-00)

**37TV, 44TV, & 29TV**

Order Part #: P-25-34232-00  
(Replaces Carrier #: 25-34232-00)

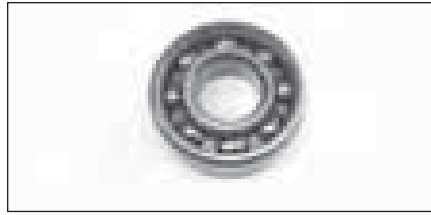

**Bearing, Fuel Cam (Front)  
91TV & 69TV**

Order Part #: P-25-15167-00  
(Replaces Carrier #: 25-15167-00)

**37TV, 44TV, & 29TV**

Order Part #: P-25-34227-00  
(Replaces Carrier #: 25-34227-00)



**Bearing, Rod  
134TV/DI**

**133DI**

**114TV/DI**

**Standard**

Order Part #: P-25-39122-00-B  
(Replaces Carrier #: 25-39122-00)

**-0.2MM**

Order Part #: P-25-38122-01-B  
(Replaces Carrier #: 25-38122-01)

**-0.4MM**

Order Part #: P-25-38122-02-B  
(Replaces Carrier #: 25-38122-02)

**114IDI**

**Standard**

Order Part #: P-25-37384-04-B  
(Replaces Carrier #: 25-37384-04)

**-0.2MM**

Order Part #: P-25-37407-00-B  
(Replaces Carrier #: 25-37407-00)

**-0.4MM**

Order Part #: P-25-37408-00-B  
(Replaces Carrier #: 25-37408-00)

114IDI

**91TV & 69TV**

**Standard**

Order Part #: P-25-15133-00-B  
(Replaces Carrier #: 25-15133-00)

**44TV & 29TV**

**Standard**

Order Part #: P-25-34386-00-B  
(Replaces Carrier #: 25-34386-00)

**-0.2MM**

Order Part #: P-25-34386-02-B  
(Replaces Carrier #: 25-34386-02)

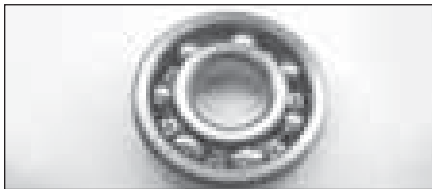

**Bearing, Governor Shaft  
69TV & 91TV**

Order Part #: P-25-15181-00  
(Replaces Carrier #: 25-15181-00)



**Bushing, Governor**

Order Part #: P-25-15008-00  
(Replaces Carrier #: 25-15008-00)



**Bushing, Piston Pin  
134/TV/DI, 133DI  
114TV/DI/IDI**

Order Part #: P-25-38121-00-B  
(Replaces Carrier #: 25-38121-00)

**91TV & 69TV**

Order Part #: P-25-15131-00  
(Replaces Carrier #: 25-15131-00)

**44TV & 29TV**

Order Part #: P-25-34384-00  
(Replaces Carrier #: 25-34384-00)



**Washer, Thrust (Std)  
114TV/DI/IDI, 133DI  
& 134TV/DI**

Order Part #: P-25-37399-00-B  
(Replaces Carrier #: 25-37399-00)



**Washer Kit, Thrust (Std)  
44TV & 29TV**

Order Part #: P-25-36430-00-B  
(Replaces Carrier #: 25-36430-00)

## Truck & Trailer Parts – ENGINE

ENGINE

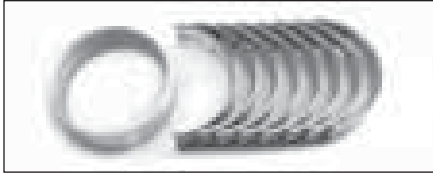

### Bearing Set, Main #1-#5 134TV/DI, 133DI & 114TV/DI

**-0.2MM**  
Order Part #: P-25-38126-01-B  
(Replaces Carrier #: 25-38126-01)

**-0.4MM**  
Order Part #: P-25-38126-02-B  
(Replaces Carrier #: 25-38126-02)



### Bearing, Main #1(Std) 134TV/DI, 133DI & 114TV/DI

Order Part #: P-25-39120-00-B  
(Replaces Carrier #: 25-39120-00)

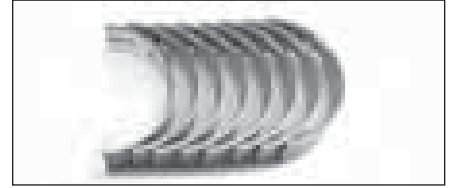

### Bearing, Main #2-#5 (Std) 134TV/DI, 133DI & 114TV/DI

Order Part #: P-25-39121-00-B  
(Replaces Carrier #: 25-39121-00)



### Bearing, #1 Main 91TV & 69TV

**Standard**  
Order Part #: P-25-15145-00-B  
(Replaces Carrier #: 25-15145-00)

**44TV & 29TV**  
**Standard**  
Order Part #: P-25-34171-00-B  
(Replaces Carrier #: 25-34171-00)

**-0.2MM (Also 37TV -0.2MM)**  
Order Part #: P-25-34389-02-B  
(Replaces Carrier #: 25-34389-02)

**-0.4MM**  
Order Part #: P-25-34389-04-B  
(Replaces Carrier #: 25-34389-04)

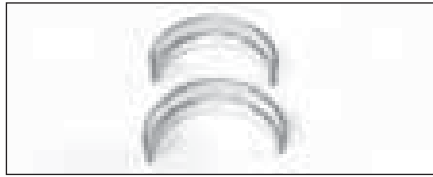

### Bearing, #2 Main 91TV & 69TV

**Standard**  
Order Part #: P-25-15148-00-B  
(Replaces Carrier #: 25-15148-00)

**44TV & 29TV**  
**Standard**  
Order Part #: P-25-34390-00-B  
(Replaces Carrier #: 25-34390-00)

**-0.2MM (Also 37 @ -0.2MM)**  
Order Part #: P-25-36428-01-B  
(Replaces Carrier #: 25-36428-01)

**-0.4MM (Also 37 @ -0.4MM)**  
Order Part #: P-25-34390-04-B  
(Replaces Carrier #: 25-34390-04)



### Bearing, #3 Main 91TV & 69TV

**Standard**  
Order Part #: P-25-15151-00-B  
(Replaces Carrier #: 25-15151-00)

**-0.2MM**  
Order Part #: P-25-15151-02-B  
(Replaces Carrier #: 25-15151-02)

**44TV & 29TV**  
**Standard**  
Order Part #: P-25-36428-00-B  
(Replaces Carrier #: 25-36428-00)

**-0.2MM (Also 37 @ -0.2MM)**  
Order Part #: P-25-34390-02-B  
(Replaces Carrier #: 25-34390-02)

**-0.4MM (Also 37 @ -0.4MM)**  
Order Part #: P-25-34391-04-B  
(Replaces Carrier #: 25-34391-04)



### Cap, Coolant Bottle

Order Part #: P-58-00743-00  
(Replaces Carrier #: 58-00743-00)



### Cap, Rain

Order Part #: 11-2916  
(Replaces Carrier #: 30-00210-00)



**Cap, Radiator**

Order Part #: P-30-00397-00  
(Replaces Carrier #: 30-00397-00)

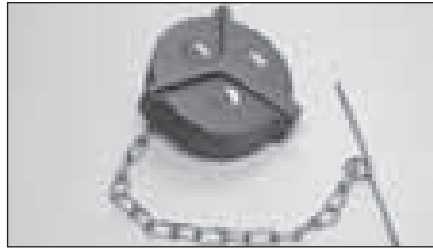

**Cap, Fuel**

Order Part #: P-44-00046-08  
(Replaces Carrier #: 44-00046-08)



**Dipstick**

Order Part #: P-25-37085-00  
(Replaces Carrier #: 25-37085-00)

**How To Order Engine Overhaul Kits:**

We show over 20 PG engine overhaul kits on this and the next two pages. Their Part #s are tailored to identify specific piston and bearing sizes as described in the example below. Overhaul kits other than the ones listed in this section can be created by your local Thermo King dealer. Just tell their parts department what engine and then specify piston and bearing sizes as below.

**Ordering Example:**

If you need a CT3-44TV Major Overhaul Kit with Standard Pistons, Second undersize Main Bearings and First undersize Rod Bearings, you would order:  
P-44TV-S21

**P-44TV- X X X**

Piston  
Code Here  
Standard = S  
+0.5mm = 1

Main Bearing  
Code here  
Standard = S  
-0.2MM = 1  
-0.4mm = 2

Rod Bearing  
Code Here  
Standard = S  
-0.2mm = 1  
-0.4mm = 2

**FOR MAJOR OVERHAULS**, the kits on this and the following pages have all the parts you need in one box.

**FOR MINOR OVERHAULS**, the kits include the same high-quality parts, however they do not include:

- Water Pump
- Oil Pump
- Glow Plugs
- Oil Pressure Switch
- Water Return Hose

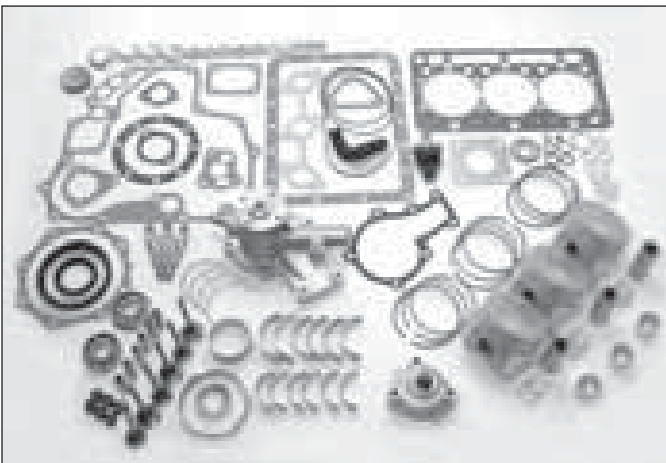

**Eng O'haul Kit MAJOR (44TV)**

Order Part #: P-44TV-1SS-B

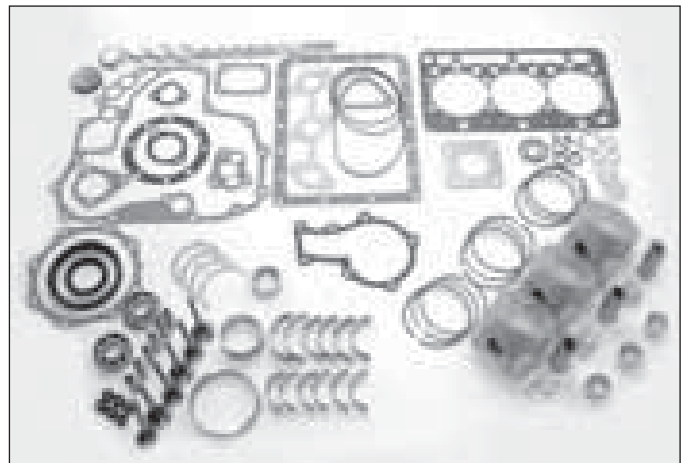

**Eng O'haul Kit, MINOR (44TV)**

Order Part #: P-44TV-M-1SS-B

Order Part #: P-44TV-M-SSS-B

## Truck & Trailer Parts – ENGINE

ENGINE

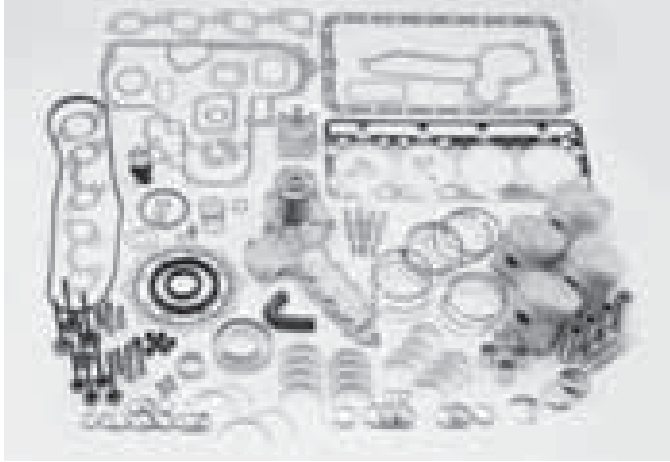

### Eng O’haul Kit (134TV)

Order Part #: P-134TV-SSS

Order Part #: P-134TV-1SS

Order Part #: P-134TV-111

Order Part #: P-134TV-121

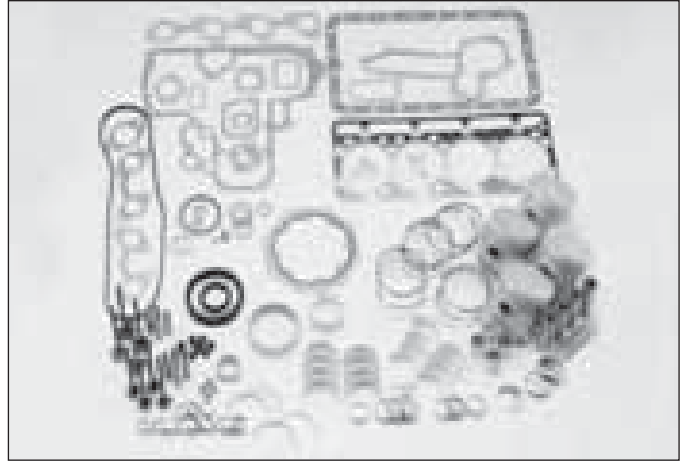

### Eng O’haul Kit, Minor (134TV)

Order Part #: P-134TV-M-111

Order Part #: P-134TV-M-1SS

Order Part #: P-134TV-M-SSS

REMEMBER, ALL MAJOR KITS INCLUDE:

- Water Pump
- Oil Pump
- Oil Pressure Switch
- Glow Plugs
- Water return hose

MINOR KITS DO NOT include those 5 items.

**SPECIAL NOTE: If you’re rebuilding either a CT4-134TV or CT4-134DI engine that has a 2 PIECE OIL PAN you need to order the Supplement Gasket Set, Part # P-25-39007-01.**

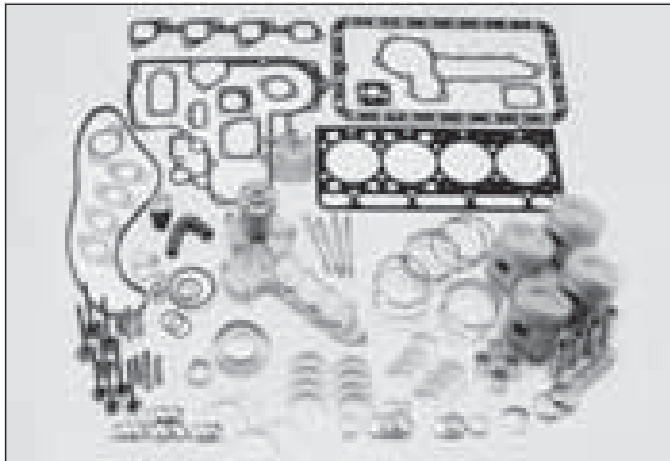

### Engine Kit, Major (134DI)

Order Part #: P-134DI-111

Order Part #: P-134DI-1SS

Order Part #: P-134DI-SSS

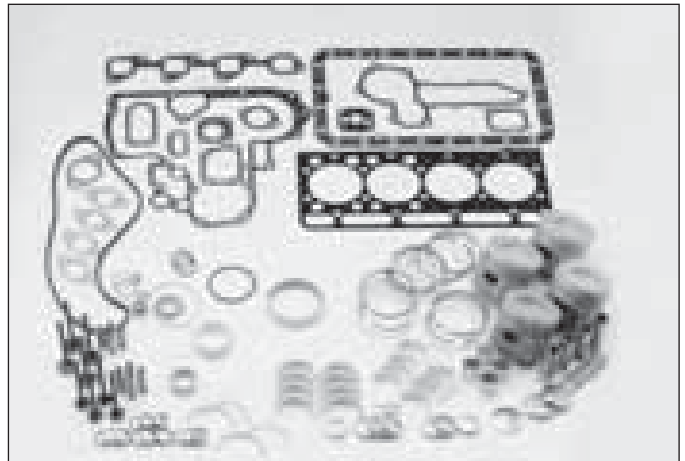

### Eng O’haul Kit, Minor (134DI)

Order Part #: P-134DI-M-1SS

Order Part #: P-134DI-M-111

REMEMBER, ALL MAJOR KITS INCLUDE:

- Water Pump
- Oil Pump
- Oil Pressure Switch
- Glow Plugs
- Water return hose

MINOR KITS DO NOT include those 5 items.

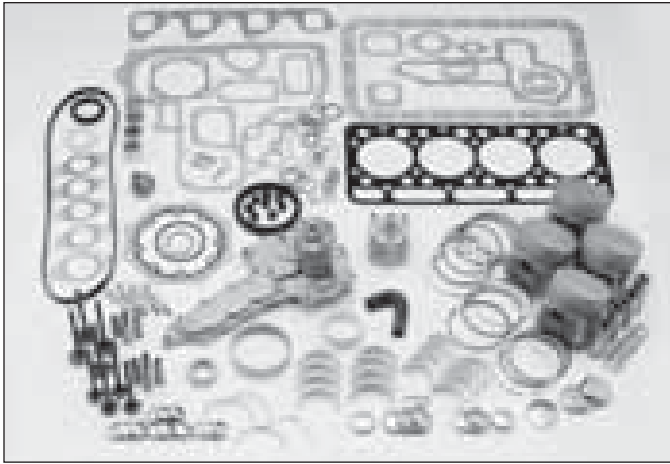

**Eng O’haul Kit, (114)**

- Order Part #: P-114-111
- Order Part #: P-114-1SS
- Order Part #: P-114-SSS

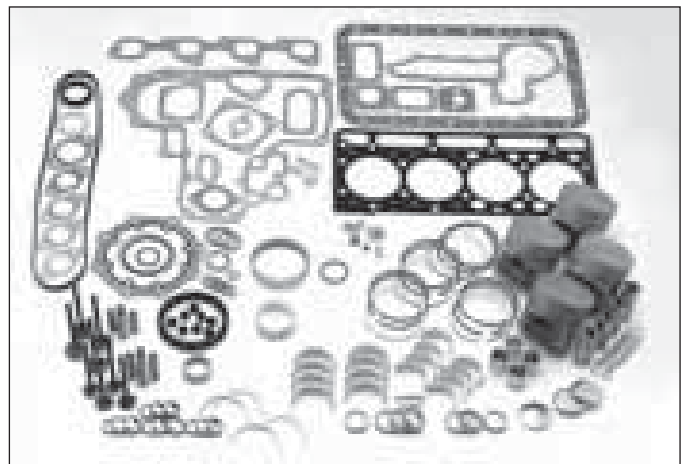

**Eng O’haul Kit, Minor (114)**

- Order Part #: P-114-M-1SS
- Order Part #: P-114-M-SSS
- Order Part #: P-114-M-111

REMEMBER, ALL MAJOR KITS INCLUDE:

- Water Pump
- Oil Pump
- Oil Pressure Switch
- Glow Plugs
- Water return hose

MINOR KITS DO NOT include those 5 items.

**SPECIAL NOTE: If you’re rebuilding a CT4-114TV engine that has a 2 PIECE OIL PAN you need to order the Supplement Gasket Set, Part # P-25-39007-01.**

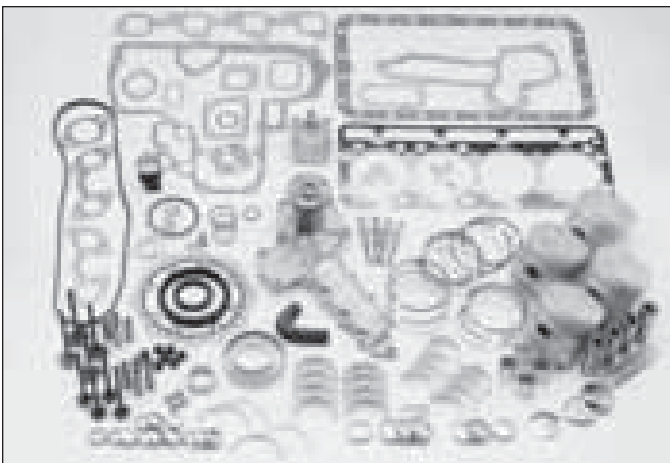

**Eng O’haul Kit, Major (114TV)**

- Order Part #: P-114TV-111
- Order Part #: P-114TV-SSS
- Order Part #: P-114TV-1SS

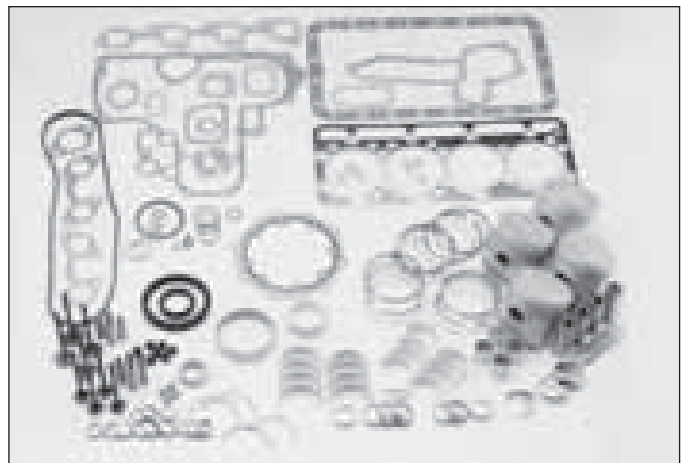

**Eng O’haul Kit, Minor (114TV)**

- Order Part #: P-114TV-M-1SS
- Order Part #: P-114TV-M-SSS

REMEMBER, ALL MAJOR KITS INCLUDE:

- Water Pump
- Oil Pump
- Oil Pressure Switch
- Glow Plugs
- Water return hose

MINOR KITS DO NOT include those 5 items.

# Truck & Trailer Parts – ENGINE

ENGINE

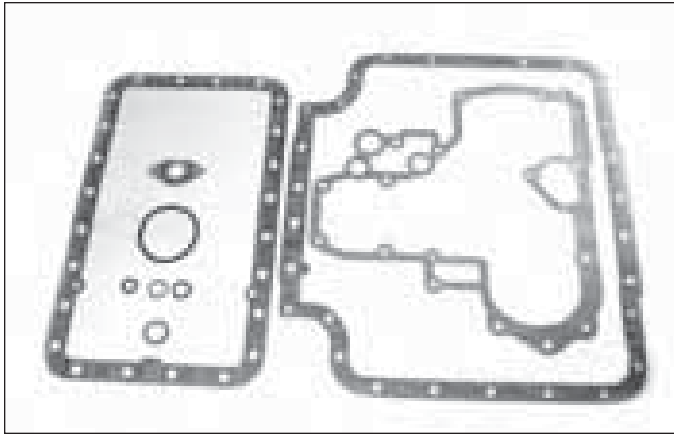

## Gasket Set, TV Ultra Supplement

Order Part #: P-25-39007-01  
 (Replaces Carrier #: 25-39007-01)

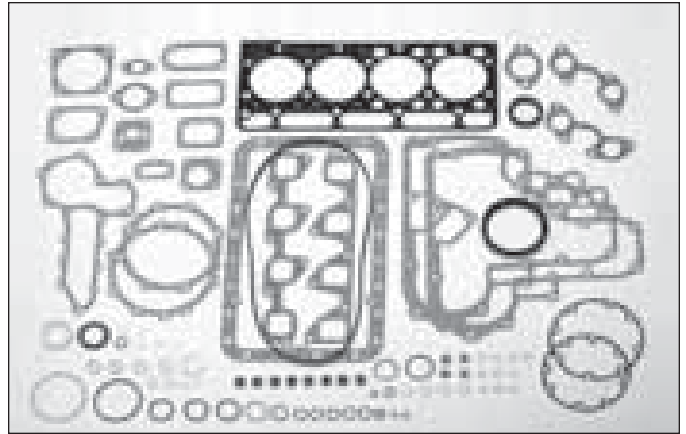

## Gasket Set (134DI & 133DI)

Order Part #: P-25-38513-00  
 (Replaces Carrier #: 25-38513-00)

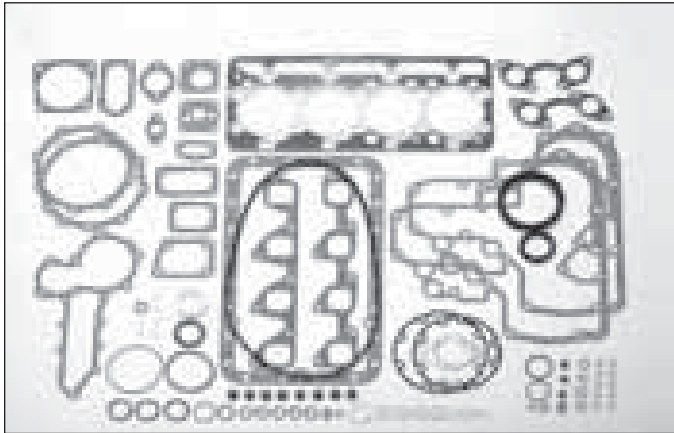

## Gasket Set (134TV)

Order Part #: P-25-39006-00  
 (Replaces Carrier #: 25-39006-00)

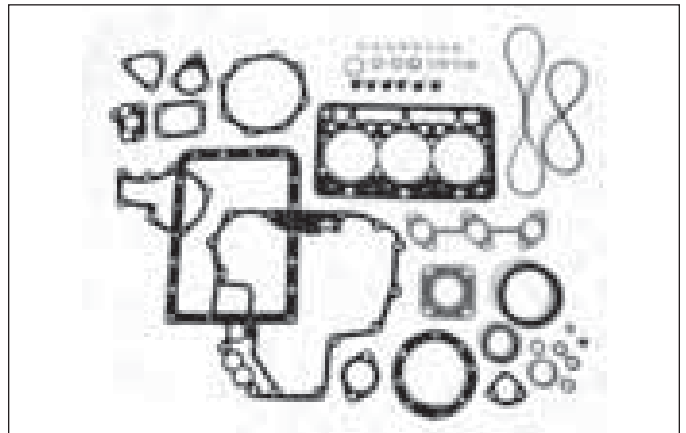

## Gasket Set (44TV)

Order Part #: P-25-34023-00  
 (Replaces Carrier #: 25-34023-00)

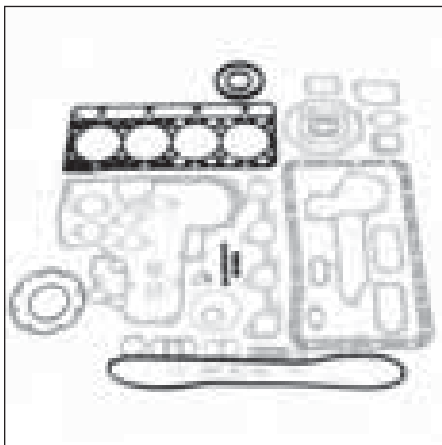

## Gasket Set (114DI)

Order Part #: P-25-38010-00  
 (Replaces Carrier #: 25-38010-00)

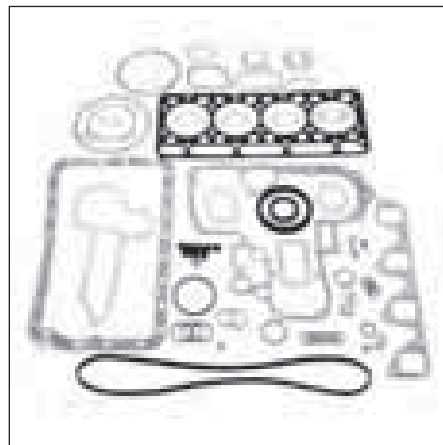

## Gasket Set (114)

Order Part #: P-25-37016-00  
 (Replaces Carrier #: 25-37016-00)

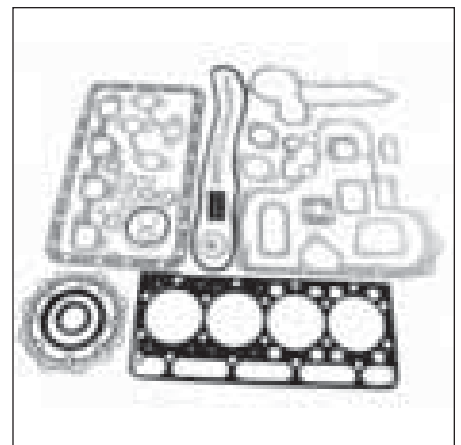

## Gasket Set (114TV)

Order Part #: P-25-39008-00  
 (Replaces Carrier #: 25-39008-00)

**MASTER FILTER CROSS REFERENCE**

MODEL	FILTER TYPE	THERMO KING PART #
<b>ADVANTAGE</b>	Filter, Air (Dry Type)	P-66U1-2155
	Filter, Fuel (Secondary)	P-30-00302-00
	Filter, Fuel (Fuel/Water Separator)	P-30-50301-01
	Filter, Oil (Bypass)	P-30-00304-00-B
	Filter, Oil – Full Flow	P-30-00323-00
<b>EAGLE</b>	Filter, Air (Dry Type)	P-66U1-2155
	Filter, Fuel (Secondary)	P-30-00302-00
	Filter, Fuel (Primary)	P-30-50301-01
	Filter, Oil (Bypass)	P-30-00304-00-B
	Filter, Oil (Full Flow)	P-30-00323-00
<b>EXTRA</b>	Filter, Air (Dry Type)	P-30-00430-23
	Filter, Fuel	P-30-01090-05
	Filter, Fuel	P-30-01079-01
	Filter, Fuel Pump (70 Micron)	P-30-01080-20
	Filter, Oil (Bypass)	P-30-00304-00-B
	Filter, Oil (Full Flow)	P-30-00323-00
<b>EXTRA XT</b>	Filter, Air (Primary) (XT Prior to SN LAA90946117)	P-30-00426-20
	Filter, Air (Primary) (XT SN LAA90946117 & After)	P-30-00471-20
	Filter, Fuel (XT)	P-30-01090-05
	Filter, Fuel Pump (70 Micron)	P-30-01080-20
	Filter, Oil (Primary)	P-30-00450-00
	Filter, Oil (Bypass)	P-30-00304-00-B
<b>EUROPHOENIX</b>	Filter, Fuel (Secondary)	P-30-00302-00
<b>GENESIS TM900/1000</b>	Filter, Air (Dry Type)	P-30-01077-01
	Filter, Fuel	P-30-01079-01
	Filter, Fuel Pump (70 Micron)	P-30-01080-20
	Filter, Oil (Bypass)	P-30-00304-00-B
	Filter, Oil (Full Flow)	P-30-00323-00
<b>GENESIS Multi-Temp TM900/1000 (SN HAD90547903 thru NAY90594028)</b>	Filter, Air (Dry Type)	P-30-00430-23
	Filter, Fuel	P-30-01079-01
	Filter, Fuel (Bowl Not Required)	P-30-01090-05
	Filter, Oil (Full Flow)	P-30-00323-00
	Filter, Oil (Bypass)	P-30-00304-00-B
<b>GENESIS TR1000</b>	Filter, Air (Primary)	P-30-00426-20
	Filter, Oil – Full Flow	P-30-00323-00
	Filter, Oil (Bypass)	P-30-00304-00-B
<b>MAXIMA</b>	Filter, Fuel	P-30-00302-00
	Filter, Fuel Pump (70 Micron)	P-30-01080-20
	Filter, Oil	P-30-50327-00
<b>OPTIMA</b>	Filter, Air (Dry Type)	P-30-00430-23
	Filter, Fuel	P-30-01079-01
	Filter (70 Micron) Fuel Pump	P-30-01080-20
	Filter, Oil (By-Pass)	P-30-00304-00-B
<b>GENESIS R70</b>	Filter, Air	P-30-60049-20
	Filter, Fuel (Secondary)	P-30-00302-00
	Filter, Fuel Pump (70 Micron)	P-30-01080-20
	Filter, Oil (Primary)	P-941172

**CONTINUED NEXT PAGE**

# Truck & Trailer Parts – ENGINE

ENGINE

## MASTER FILTER CROSS REFERENCE (continued)

MODEL	FILTER TYPE	THERMO KING PART #
<b>GENESIS R90</b>	Filter, Air (New)	P-30-60049-20
	Filter, Air (Dry Type) (Old)	P-25-35250-02
	Filter, Fuel	P-30-00302-00
	Filter Fuel Pump (70 Micron)	P-30-01080-20
	Filter, Oil (Full Flow)	P-30-00323-00
<b>THUNDERBIRD</b>	Filter, Air (Dry Type)	P-66U1-2155
	Filter, Fuel (Secondary)	P-30-00302-00
	Filter, Fuel (Primary)	P-30-50301-01
	Filter, Oil (Bypass)	P-30-00304-00-B
	Filter, Oil (Full Flow)	P-30-00323-00
<b>ULTIMA</b>	Filter, Air (Starting w/SN FAR90427529)	P-30-00430-23
	Filter, Air	P-30-01077-01
	Filter, Fuel (Bowl Not Required)	P-30-01090-05
	Filter, Fuel	P-30-01079-01
	Filter, Fuel Pump (70 Micron)	P-30-01080-20
	Filter, Oil (Bypass)	P-30-00304-00-B
	Filter, Oil (Full Flow)	P-30-00323-00
<b>ULTIMA XTC</b>	Filter, Air (ESI)	P-30-00426-27
	Filter, Air (Primary) (XT SN LAA90946117 & After)	P-30-00471-20
	Filter, Fuel (Bowl Not Required)	P-30-01090-05
	Filter, Fuel	P-30-01079-01
	Filter, Oil (ESI Primary)	P-30-00463-00
	Filter, Oil (Primary)	P-30-00450-00
<b>ULTRA and ULTRA XL</b>	Filter, Air (Dry Type)	P-30-01077-01
	Filter, Fuel	P-30-01079-01
	Filter, Fuel (XL) Prior to SN DAW90273677	P-30-01079-01
	Filter, Oil (Bypass)	P-30-00304-00-B
	Filter, Oil (Full Flow)	P-30-00323-00
<b>ULTRA XT</b>	Filter, Air (Primary) (XT, Prior to SN LAA90946117)	P-30-00426-20
	Filter, Air (Primary) (XT, SN LAA90946117 & After)	P-30-00471-20
	Filter, Fuel (Primary)	P-30-01090-05
	Filter, Fuel Pump (70 Micron)	P-30-01080-20
	Filter, Oil (Primary)	P-30-00450-00
<b>ULTRA XTC</b>	Filter, Air (ESI)	P-30-00426-27
	Filter, Air (Primary) (XT SN LAA90946117 & After)	P-30-00471-20
	Filter, Fuel (Primary)	P-30-01090-05
	Filter, Oil (ESI Primary)	P-30-00463-00
	Filter, Oil (Primary)	P-30-00450-00
<b>SUPRA 922/944</b>	Filter, Air (New)	P-30-60049-20
	Filter, Air (Dry Type) (Old)	P-25-35250-02
	Filter, Fuel (w/out Heater) (Starting w/SN EFY90375766)	P-30-01090-05
	Filter, Fuel (Used w/Water Sep.) (Prior to SN EFY90375766)	P-30-01079-01
	Filter, Fuel	P-30-00302-00
	Filter, Fuel Pump (70 Micron)	P-30-01080-20
	Filter, Oil (Full Flow)	P-30-00323-00

**MASTER FILTER CROSS REFERENCE (continued)**

MODEL	FILTER TYPE	THERMO KING PART #
SUPRA 844	Filter, Air	P-30-60049-20
	Filter, Fuel (Bowl Not Required)	P-30-01090-05
	Filter, Fuel	P-30-01079-01
	Filter, Fuel Pump (70 Micron)	P-30-01080-20
	Filter, Oil – Bypass	P-30-00304-00-B
	Filter, Oil (Primary)	P-941172
SUPRA 722/744 and SUPRA 622/644	Filter, Fuel (Used w/Water Sep.)	P-30-01079-01
	Filter, Fuel (w/out heater)	P-30-01090-05
	Filter, Fuel Pump (70 Micron)	P-30-01080-20
	Filter, Oil (Bypass)	P-30-00304-00-B
	Filter, Oil – Full Flow, Model 1999 (N.A.O.)	P-30-00323-00
	Filter, Oil	P-941172
SUPRA 422	Filter, Fuel	P-30-01090-05
	Filter, Fuel (Used w/Water Sep.)	P-30-01079-01
	Filter, Fuel Pump (70 Micron)	P-30-01080-20
	Filter, Oil (By-Pass)	P-30-00304-00-B
	Filter, Oil	P-941172
SOLARA	Filter, Fuel	P-30-01079-01
	Filter, Fuel Pump (70 Micron)	P-30-01080-20

**ORDER CODE FOR FILTERS:**

**Air filters** are available as singles through Thermo King – Use standard part number (i.e. P-30-00430-23).

**Oil and fuel filters:**

These are available through Thermo King in case quantities by using the standard part number (i.e. P-30-00463-00)

For Oil and Fuel Filters as singles, add an S to the part number (i.e. P-30-00463-00S)

Note: Dealers can order quantities of 30 or more (cases for fuel and oil or single filters for air) through our drop-ship program by adding an A to the part number (i.e. P-30-00463-00A)



**Filter, Fuel Pump (Electric)  
(70 Micron)**

Order Part #: P-30-01080-20  
(Replaces Carrier #: 30-01080-20)



**Filter, Air**

Order Part #: P-30-00430-23  
(Replaces Carrier #: 30-00430-23)



**Filter, Air**

Order Part #: P-30-01077-01  
(Replaces Carrier #: 30-01077-01)

## Truck & Trailer Parts – ENGINE

ENGINE

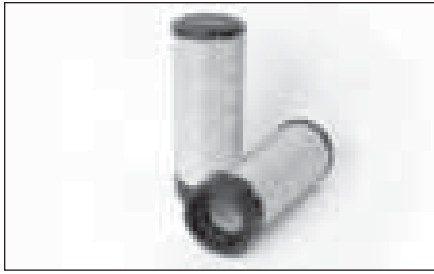

### Filter, Air (ESI)

Order Part #: P-30-00426-27  
(Replaces Carrier #: 30-00426-27)

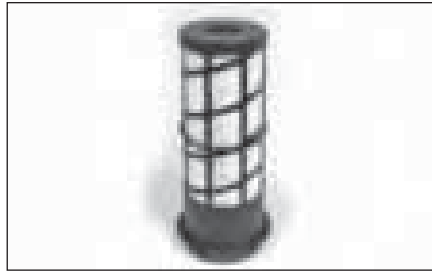

### Filter, Air (Primary) XT, XTC

Order Part #: P-30-00426-20  
(Replaces Carrier #: 30-00426-20)

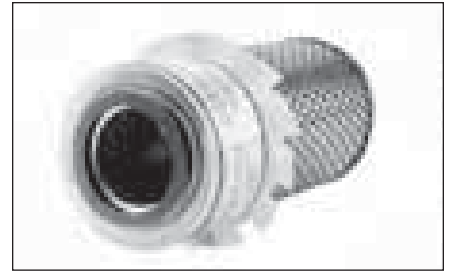

### Filter, Air (Dry Type)

Order Part #: P-25-35250-02  
(Replaces Carrier #: 25-35250-02)



### Filter, Air

Order Part #: P-30-60049-20  
(Replaces Carrier #: 30-60049-20)



### Filter, Air (Dry Type)

Order Part #: P-66U1-2155  
(Replaces Carrier #: 66U1-2155)

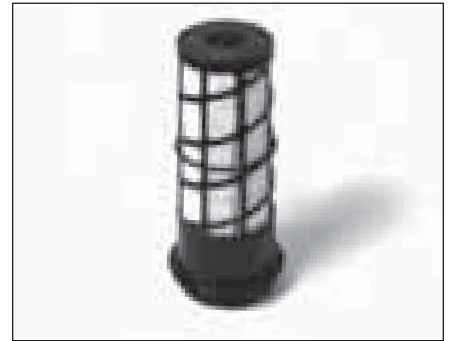

### Filter, Air

(Serial # LAA90946117 & Beyond)  
Order Part #: P-30-00471-20  
(Replaces Carrier #: 30-00471-20)



### Filter, Oil

Order Part #: P-30-00323-00  
(Replaces Carrier #: 30-00323-00)

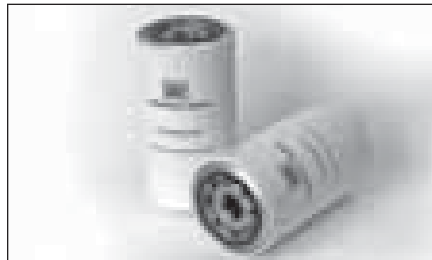

### Filter, Oil (ESI Primary XTC)

Order Part #: P-30-00463-00  
(Replaces Carrier #: 30-00463-00)



### Drain Cock

Order Part #: P-25-37593-00  
(Replaces Carrier #: 25-37593-00)



### 80 Micron Fuel Pump Filter

Order Part #: 10-376

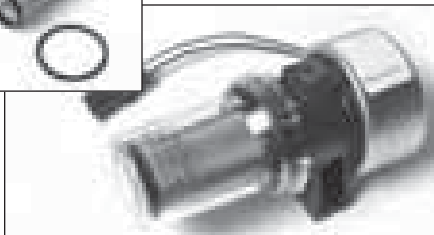

### Fuel Pump Assembly

Order Part #: 41-7059  
(Replaces Carrier #: 30-01108-01SV)

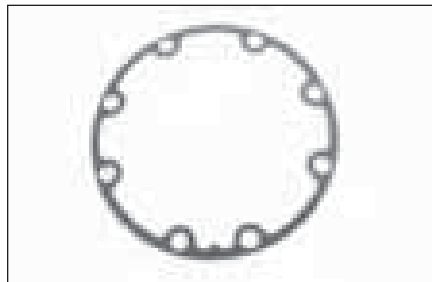

### Gasket, Bearing

Order Part #: P-25-37195-01  
(Replaces Carrier #: 25-37195-01)

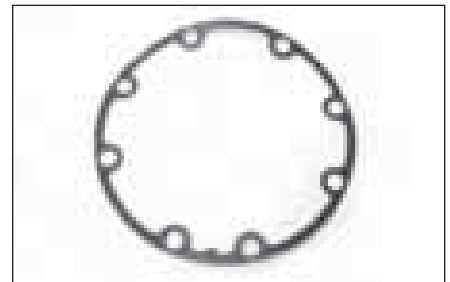

### Gasket, Bearing

Order Part #: P-25-38557-00-B  
(Replaces Carrier #: 25-38557-00)

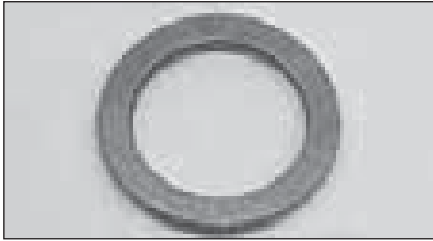

**Gasket, Copper**

Order Part #: 55-2208  
(Replaces Carrier #: 25-38666-13)



**Gasket, Cover**

Order Part #: P-30-01044-21  
(Replaces Carrier #: 30-01044-21)

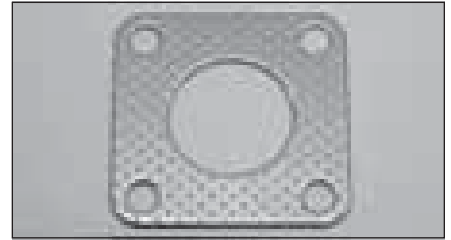

**Gasket, Exhaust**

Order Part #: P-25-33020-00  
(Replaces Carrier #: 25-33020-00)

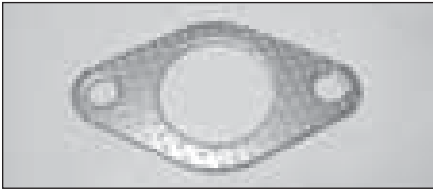

**Gasket, Exhaust Manifold**

Order Part #: P-25-37236-01  
(Replaces Carrier #: 25-37236-01)

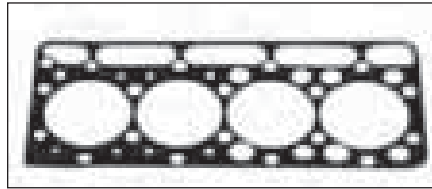

**Gasket, Head (CT4-114)**

Order Part #: P-25-37115-04-B  
(Replaces Carrier #: 25-37115-04)

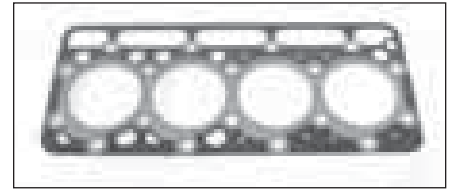

**Gasket, Head (CT4-114TV)**

Order Part #: P-25-39113-00-B  
(Replaces Carrier #: 25-39113-00)

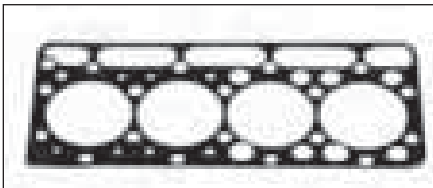

**Gasket, Head (CT4-134DI)**

Order Part #: P-25-38529-01-B  
(Replaces Carrier #: 25-38529-01)



**Gasket, Head (CT4-134TV)**

Order Part #: P-25-38532-00-B  
(Replaces Carrier #: 25-38532-00)

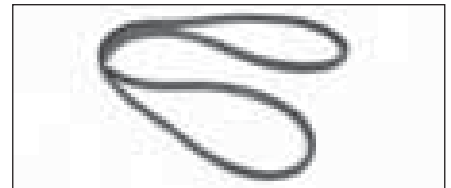

**Gasket, Head Cover**

Order Part #: P-25-37307-00-B  
(Replaces Carrier #: 25-37307-00)

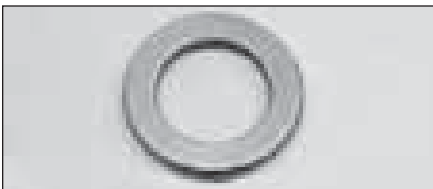

**Gasket, Injector**

Order Part #: P-25-34216-00  
(Replaces Carrier #: 25-34216-00)

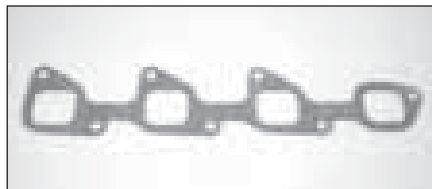

**Gasket, Manifold**

Order Part #: P-25-38076-00-B  
(Replaces Carrier #: 25-38076-00)



**Gasket, Muffler**

Order Part #: P-25-37238-00-B  
(Replaces Carrier #: 25-37238-00)

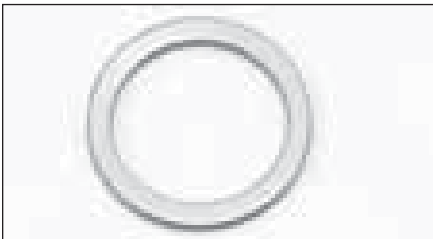

**Gasket, Valve**

Order Part #: P-25-35629-00  
(Replaces Carrier #: 25-35629-00)

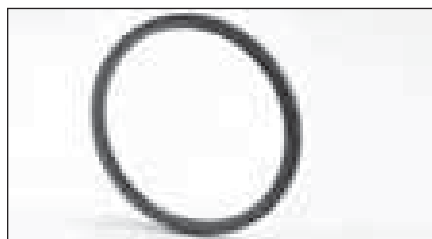

**Gear, Ring**

Order Part #: P-25-37420-12  
(Replaces Carrier #: 25-37420-12)

## Truck & Trailer Parts – ENGINE

ENGINE

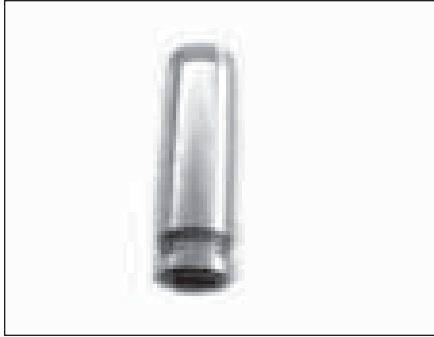

### Guide, Exhaust Valve

Order Part #: P-25-34039-00-B  
(Replaces Carrier #: 25-34039-00)

### Guide, Exhaust Valve

Order Part #: P-25-39037-00-B  
(Replaces Carrier #: 25-39037-00)



### Guide, Intake Valve

Order Part #: P-25-39036-00  
(Replaces Carrier #: 25-39036-00)

### Guide, Intake Valve

Order Part #: P-25-34038-00-B  
(Replaces Carrier #: 25-34038-00)

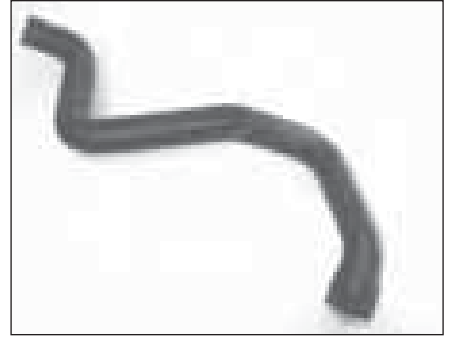

### Hose, Air (Dry Type)

Order Part #: P-58-04157-00  
(Replaces Carrier #: 58-04157-00)



### Valve, Intake

Order Part #: P-25-15460-00  
(Replaces Carrier #: 25-15460-00)

### Valve, Intake

Order Part #: P-25-34110-00-B  
(Replaces Carrier #: 25-34110-00)

### Valve, Intake

Order Part #: P-25-37260-00-B  
(Replaces Carrier #: 25-37260-00)

### Valve, Intake

Order Part #: P-25-38085-00-B  
(Replaces Carrier #: 25-38085-00)

### Valve, Intake

Order Part #: P-25-39085-00-B  
(Replaces Carrier #: 25-39085-00)



### Valve, Exhaust

Order Part #: P-25-34111-00-B  
(Replaces Carrier #: 25-34111-00)

### Valve, Exhaust

Order Part #: P-25-37261-00-B  
(Replaces Carrier #: 25-37261-00)

### Valve, Exhaust

Order Part #: P-25-38086-00-B  
(Replaces Carrier #: 25-38086-00)

### Valve, Exhaust

Order Part #: P-25-39086-00-B  
(Replaces Carrier #: 25-39086-00)



### Hose, Air

Order Part #: P-58-60090-00  
(Replaces Carrier #: 58-60090-00)



### Hose, Air (Dry Type)

Order Part #: P-58-04074-00  
(Replaces Carrier #: 58-04074-00)



### Hose, Coolant

Order Part #: P-58-60039-19  
(Replaces Carrier #: 58-60039-19)

**HOSES BY MODEL**

Thermo King #	Description	Carrier #
<b>ADVANTAGE</b>		
P-58-00659-00	Hose, Fuel 3/16 25'	58-00659-00
P-58-00904-00	Hose, Radiator (Fill)	58-00904-00
P-58-00227-00	Hose, Radiator (Inlet, Lower)	58-00227-00
P-58-00903-00	Hose, Radiator (Inlet, Upper)	58-00903-00
P-58-00801-00	Hose, Radiator (Outlet, Lower)	58-00801-00
P-58-00902-02	Hose, Radiator (Outlet, Upper)	58-00902-02
<b>EAGLE</b>		
P-58-00253-00	Hose, Drain (Condensate)	58-00253-00
P-58-00659-00	Hose, Fuel 3/16 25'	58-00659-00
P-58-00922-00	Hose, Radiator (Inlet)	58-00922-00
P-58-00921-00	Hose, Radiator (Outlet)	58-00921-00
<b>EUROPHOENIX</b>		
P-58-00659-00	Hose, Fuel 3/16 25'	58-00659-00
<b>EXTRA</b>		
P-58-04074-00	Hose, Air (Dry Type)	58-04074-00
P-58-00253-00	Hose, Drain (Condensate)	58-00253-00
P-58-00659-00	Hose, Fuel 3/16 25'	58-00659-00
P-58-04080-00	Hose, Radiator (Inlet, Upper)	58-04080-00
P-58-04079-00	Hose, Radiator (Outlet, Lower)	58-04079-00
<b>GENESIS</b>		
P-58-00659-00	Hose, Fuel 3/16 25'	58-00659-00
P-58-00227-00	Hose, Radiator (Inlet, Lower)	58-00227-00
<b>MAXIMA</b>		
P-58-00659-00	Hose, Fuel 3/16 25'	58-00659-00
P-25-15411-00	Hose, Water Return	25-15411-00
<b>OPTIMA</b>		
P-58-04157-00	Hose, Air (Dry Type)	58-04157-00
P-58-00253-00	Hose, Drain (Condensate)	58-00253-00
P-58-00659-00	Hose, Fuel 3/16 25'	58-00659-00
P-58-04155-00	Hose, Radiator (Inlet, Upper)	58-04155-00
P-25-15411-00	Hose, Water Return	25-15411-00
<b>THUNDERBIRD</b>		
P-58-00253-00	Hose, Drain (Condensate)	58-00253-00
P-58-00659-00	Hose, Fuel 3/16 25'	58-00659-00
P-58-00904-00	Hose, Radiator (Fill)	58-00904-00
P-58-00227-00	Hose, Radiator (Inlet, Lower)	58-00227-00
P-58-00903-00	Hose, Radiator (Inlet, Upper)	58-00903-00
P-58-00801-00	Hose, Radiator (Outlet, Lower)	58-00801-00
P-58-00902-02	Hose, Radiator (Outlet, Upper)	58-00902-02

(continued next page)

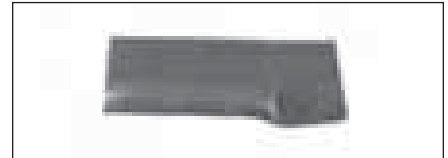

**Hose, Drain (Condensate)**

Order Part #: P-58-00253-00  
(Replaces Carrier #: 58-00253-00)

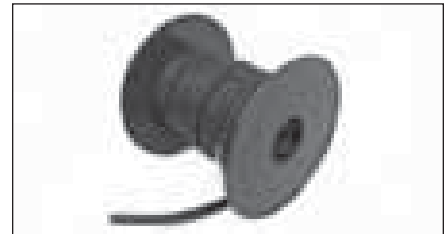

**Hose, Fuel 3/16 25'**

Order Part #: P-58-00659-00  
(Replaces Carrier #: 58-00659-00)

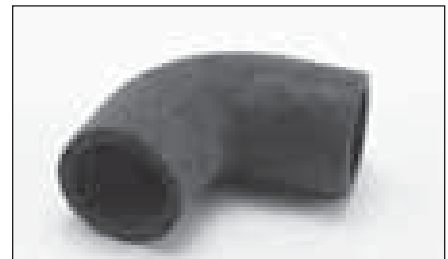

**Hose, Formed (AIR)**

Order Part #: P-58-04203-01  
(Replaces Carrier #: 58-04203-01)



**Hose, Formed (AIR)**

Order Part #: P-58-00976-00  
(Replaces Carrier #: 58-00976-00)

# Truck & Trailer Parts – ENGINE

ENGINE

## HOSES BY MODEL – Con't

Thermo King #	Description	Carrier #
<b>ULTIMA</b>		
P-58-00253-00	Hose, Drain (Condensate)	58-00253-00
P-58-00659-00	Hose, Fuel 3/16 25'	58-00659-00
P-58-00227-00	Hose, Radiator (Inlet, Lower)	58-00227-00
P-58-01317-00	Hose, Radiator (Outlet, Lower)	58-01317-00
P-58-04223-04	Hose, Radiator (Outlet, Upper)	58-04223-04
<b>ULTRA</b>		
P-58-04074-00	Hose, Air (Dry Type)	58-04074-00
P-58-00253-00	Hose, Drain (Condensate)	58-00253-00
P-58-00659-00	Hose, Fuel 3/16 25'	58-00659-00
P-58-04080-00	Hose, Radiator (Inlet, Upper)	58-04080-00
P-58-04079-00	Hose, Radiator (Outlet, Lower)	58-04079-00
<b>VATNA</b>		
P-58-00659-00	Hose, Fuel 3/16 25'	58-00659-00
<b>VECTOR</b>		
P-58-00659-00	Hose, Fuel 3/16 25'	58-00659-00
<b>SUPRA 922/944</b>		
P-58-60039-19	Hose, Coolant	58-60039-19
P-58-00659-00	Hose, Fuel 3/16 25'	58-00659-00
P-58-60039-00	Hose, Radiator	58-60039-00
<b>SUPRA 922/944 (continued)</b>		
P-58-60189-00	Hose, Radiator (Lower)	58-60189-00
P-58-60039-15	Hose, Upper Radiator	58-60039-15
P-25-15411-00	Hose, Water Return	25-15411-00

(continued next page)



**Hose, Formed (ENG TO RAD)**  
Order Part #: P-58-04216-00  
(Replaces Carrier #: 58-04216-00)

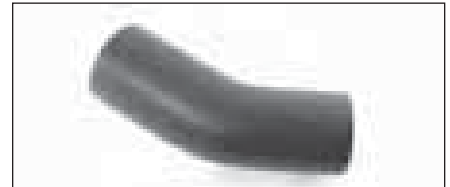

**Hose, Radiator (Fill)**  
Order Part #: P-58-00904-00  
(Replaces Carrier #: 58-00904-00)



**Hose, Formed (Rad To WP)**  
Order Part #: P-58-04215-00  
(Replaces Carrier #: 58-04215-00)



**Hose, Lower Radiator**  
Order Part #: P-58-60039-21  
(Replaces Carrier #: 58-60039-21)



**Hose, Radiator**  
Order Part #: P-58-60039-00  
(Replaces Carrier #: 58-60039-00)



**Hose, Radiator (Inlet, Lower)**  
Order Part #: P-58-00227-00  
(Replaces Carrier #: 58-00227-00)



**Hose, Radiator (Inlet, Upper)**  
Order Part #: P-58-04080-00  
(Replaces Carrier #: 58-04080-00)

**HOSES BY MODEL – Con't**

Thermo King #	Description	Carrier #
<b>SUPRA 844</b>		
P-58-00659-00	Hose, Fuel 3/16 25'	58-00659-00
<b>SUPRA 722/744 &amp; Supra 622/644</b>		
P-58-60090-00	Hose, Air	58-60090-00
P-58-00659-00	Hose, Fuel 3/16 25'	58-00659-00
P-58-60039-21	Hose, Lower Radiator	58-60039-21
P-58-60002-00	Hose, Radiator (Upper)	58-60002-00
P-58-60344-00	Hose, Upper Radiator	58-60344-00
P-25-34329-00	Hose, Water Return	25-34329-00
<b>SUPRA 550</b>		
P-58-00659-00	Hose, Fuel 3/16 25'	58-00659-00
<b>SUPRA 422</b>		
P-58-00659-00	Hose, Fuel 3/16 25'	58-00659-00
P-58-60039-08	Hose, Radiator (Upper)	58-60039-08
P-25-34308-00	Hose, Water Return	25-34308-00

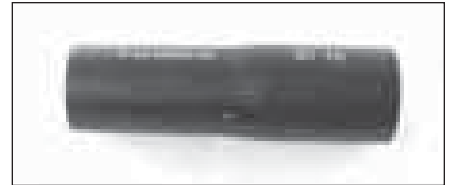

**Hose, Radiator (Inlet, Upper)**

Order Part #: P-58-00903-00  
(Replaces Carrier #: 58-00903-00)

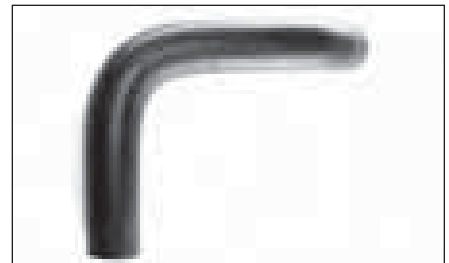

**Hose, Radiator (Lower)**

Order Part #: P-58-60189-00  
(Replaces Carrier #: 58-60189-00)

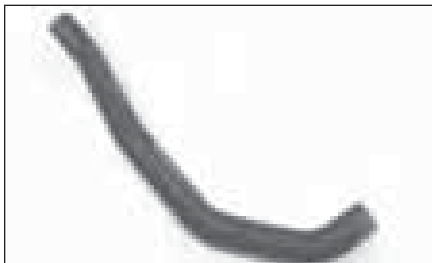

**Hose, Radiator (Inlet, Upper)**

Order Part #: P-58-04155-00  
(Replaces Carrier #: 58-04155-00)

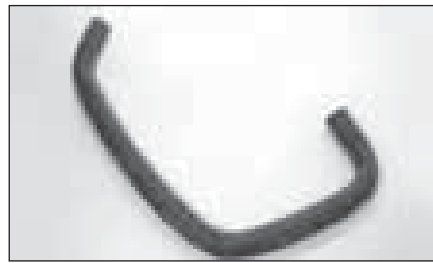

**Hose, Radiator (Inlet)**

Order Part #: P-58-00922-00  
(Replaces Carrier #: 58-00922-00)



**Hose, Radiator (Outlet, Lower)**

Order Part #: P-58-04079-00  
(Replaces Carrier #: 58-04079-00)



**Hose, Radiator (Outlet, Lower)**

Order Part #: P-58-00801-00  
(Replaces Carrier #: 58-00801-00)



**Hose, Radiator (Outlet, Lower)**

Order Part #: P-58-01317-00  
(Replaces Carrier #: 58-01317-00)

## Truck & Trailer Parts – ENGINE

ENGINE



### Hose, Radiator (Outlet, Upper)

Order Part #: P-58-00902-02  
(Replaces Carrier #: 58-00902-02)

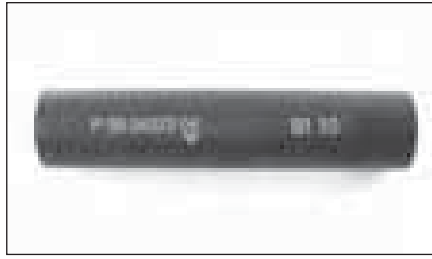

### Hose, Radiator (Outlet, Upper)

Order Part #: P-58-04223-04  
(Replaces Carrier #: 58-04223-04)

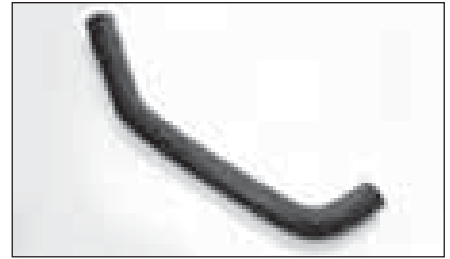

### Hose, Radiator (Outlet)

Order Part #: P-58-00921-00  
(Replaces Carrier #: 58-00921-00)

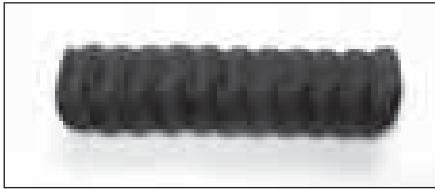

### Hose, Radiator (Upper)

Order Part #: P-58-60002-00  
(Replaces Carrier #: 58-60002-00)

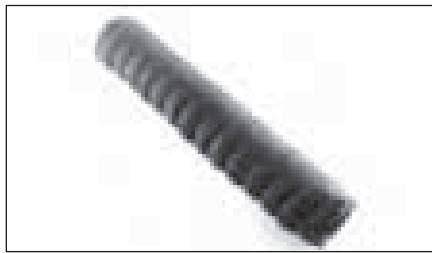

### Hose, Radiator (Upper)

Order Part #: P-58-60039-08  
(Replaces Carrier #: 58-60039-08)



### Hose, Upper Radiator

Order Part #: P-58-60039-15  
(Replaces Carrier #: 58-60039-15)



### Hose, Upper Radiator

Order Part #: P-58-60344-00  
(Replaces Carrier #: 58-60344-00)



### Hose, Water Return

Order Part #: P-25-15411-00  
(Replaces Carrier #: 25-15411-00)



### Hose, Water Return

Order Part #: P-25-34308-00  
(Replaces Carrier #: 25-34308-00)



### Hose, Water Return

Order Part #: P-25-34329-00  
(Replaces Carrier #: 25-34329-00)

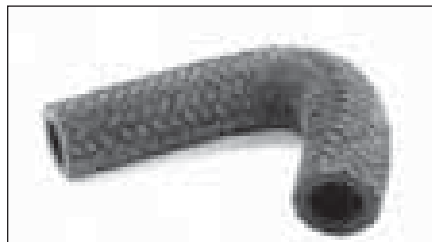

### Tube, Water Return

Order Part #: P-25-37556-00  
(Replaces Carrier #: 25-37556-00)



**Injector, Fuel (114DI)  
(w/o gasket or seal)**  
Order Part #: P-25-37625-00  
(Replaces Carrier #: 25-37625-00)



**Injector, Fuel (114DI)  
(complete w/seal)**  
Order Part #: P-25-38155-00  
(Replaces Carrier #: 25-38155-00)



**Injector, Fuel  
(134DI & 133DI)  
(complete w/seal)**  
Order Part #: P-25-38640-00  
(Replaces Carrier #: 25-38640-00)



**Injector, Fuel (134TV)  
(w/gasket & seal)**  
Order Part #: P-25-39145-01-B  
(Replaces Carrier #: 25-39145-01)



**Injector, Fuel (29TV & 44TV)  
(w/o gasket or seal)**  
Order Part #: P-25-34830-00SV  
(Replaces Carrier #: 25-34830-00SV)



**Injector, Fuel (69TV & 91TV)  
(w/o gasket or seal)**  
Order Part #: P-25-15327-00SV  
(Replaces Carrier #: 25-15327-00SV)

**Fuel Injector Gaskets & Seals for 29TV, 44TV, 69TV, 91TV, & 134TV Engines**

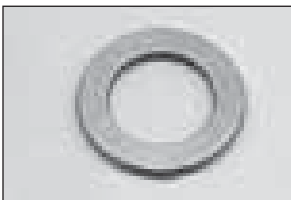

**Gasket**  
Order Part #: P-25-34216-00  
Replaces Carrier #: 25-34216+00

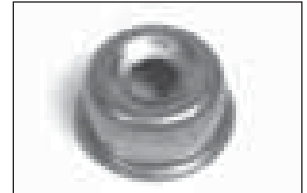

**Seal**  
Order Part #: P-25-39147-00  
Replaces Carrier #: 25-39147-00

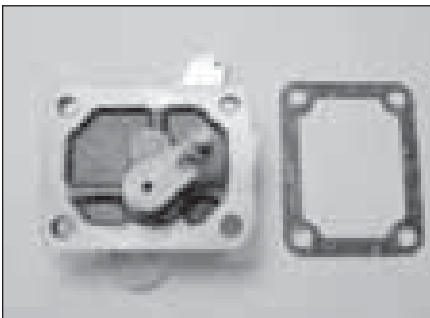

**Lever, Engine Stop**  
Order Part #: P-25-38710-01  
(Replaces Carrier #: 25-38710-01)



**Lever, Speed Control**  
Order Part #: P-25-37503-00SV  
(Replaces Carrier #: 25-37503-00SV)

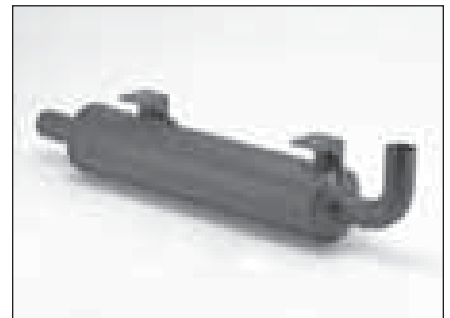

**Muffler**  
Order Part #: P-30-00401-06  
(Replaces Carrier #: 30-00401-06)

## Truck & Trailer Parts – ENGINE

ENGINE



### Muffler

Order Part #: P-30-01087-00  
(Replaces Carrier #: 30-01087-00)



### Pipe, Lower Exhaust

Order Part #: P-30-00402-01  
(Replaces Carrier #: 30-00402-01)

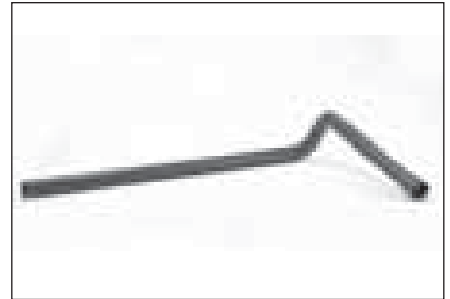

### Pipe, Upper Exhaust

Order Part #: P-30-00402-05  
(Replaces Carrier #: 30-00402-05)

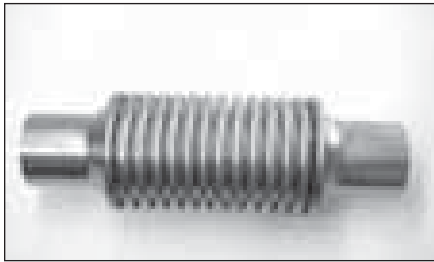

### Pipe, Flex Exhaust

Order Part #: P-30-01237-00  
(Replaces Carrier #: 30-01237-00)



### O-Ring

Order Part #: P-25-34341-00  
(Replaces Carrier #: 25-34341-00)



### Piston Assy w/Rings (Std) (114TV)

Serial # prior to 1e  
Order Part #: P-25-39117-01-B  
(Replaces Carrier #: 25-39117-01)  
**(+0.5MM)**  
Order Part #: P-25-39117-03-B  
(Replaces Carrier #: 25-39117-03)



### Piston Assy w/Rings (Std) (114DI)

Order Part #: P-25-37417-00-B  
(Replaces Carrier #: 25-37417-00)  
**(+ 0.5MM)**  
Order Part #: P-25-37417-05-B  
(Replaces Carrier #: 25-37417-05)



### Piston Assy w/o Rings (114DI) (Std)

Order Part #: P-25-38115-11  
(Replaces Carrier #: 25-38115-11)  
**(+ 0.5MM)**  
Order Part #: P-25-38115-02  
(Replaces Carrier #: 25-38115-02)

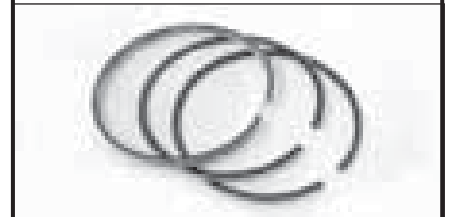

### Ring Set, Piston (114TV) (Std)

Order Part #: P-25-39119-00-B  
(Replaces Carrier #: 25-39119-00)  
**(+0.5MM)**  
Order Part #: P-25-39119-01-B  
(Replaces Carrier #: 25-39119-01)

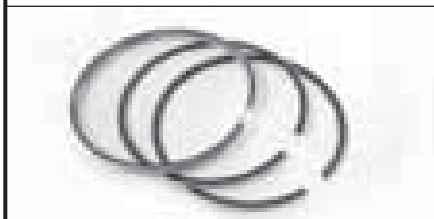

### Ring Set, Piston 114DI/114IDI (Std)

Order Part #: P-25-37383-00-B  
(Replaces Carrier #: 25-37383-00)  
**(+0.5MM)**  
Order Part #: P-25-37406-00-B  
(Replaces Carrier #: 25-37406-00)



**Piston Assy w/o Rings  
(Std) (134TV)**

(SN prior to 210389)  
Order Part #: P-25-39110-01-B  
(Replaces Carrier #: 25-39110-01)  
**(+ 0.5MM)**  
Order Part #: P-25-39110-03-B  
(Replaces Carrier #: 25-39110-03)

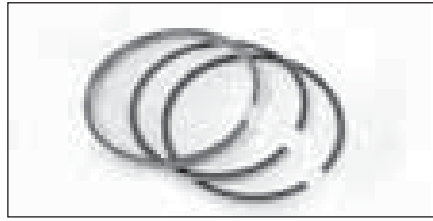

**Ring Set, Piston  
134TV/DI (+ 0.5MM)**

Order Part #: P-25-38611-01-B  
(Replaces Carrier #: 25-38611-01)



**Piston Assy w/o Rings  
(Std) (134DI)**

Order Part #: P-25-39127-01-B  
(Replaces Carrier #: 25-39127-01)  
**(+0.5MM)**  
Order Part #: P-25-39128-01-B  
(Replaces Carrier #: 25-39128-01)



**Piston Assy w/Rings  
(Std) (44TV/29TV)**

Order Part #: P-25-34380-00SVB  
(Replaces Carrier #: 25-34380-00SV)  
**(+ 0.25MM)**  
Order Part #: P-25-34380-05SVB  
(Replaces Carrier #: 25-34380-05SV)



**Plug Set, Expansion  
(Block)**

Order Part #: P-25-37020-00  
(Replaces Carrier #: 25-37020-00)

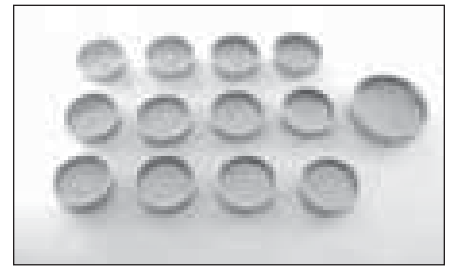

**Plug Set, Expansion  
(Head)**

Order Part #: P-25-37021-00  
(Replaces Carrier #: 25-37021-00)



**Ring Set, Piston  
44TV/29TV (Std)**

Order Part #: P-25-34381-00  
(Replaces Carrier #: 25-34381-00)  
**(+0.25MM)**  
Order Part #: P-25-34381-05-B  
(Replaces Carrier #: 25-34381-05)

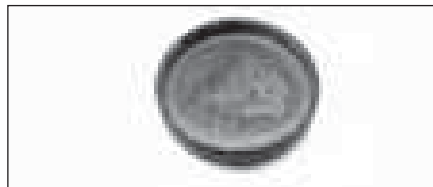

**Plug, Fuel Cam**

Order Part #: P-25-34018-00  
(Replaces Carrier #: 25-34018-00)

**See Next Page for More Expansion Plugs** →

# Truck & Trailer Parts – ENGINE

ENGINE

## Plug, Expansion (Sold individually)

### 134TV/DI

### 133DI

### 114DI/IDI

Order Part #: P-25-37107-00

(Replaces Carrier #: 25-37107-00)

Order Part #: P-25-37032-00

(Replaces Carrier #: 25-37032-00)

Order Part #: P-25-37033-00

(Replaces Carrier #: 25-37033-00)

### 91TV

Order Part #: P-25-37107-00

(Replaces Carrier #: 25-37107-00)

Order Part #: P-25-15004-00

(Replaces Carrier #: 25-15004-00)

Order Part #: P-25-15006-00

(Replaces Carrier #: 25-15006-00)

Order Part #: P-25-34006-00

(Replaces Carrier #: 25-34006-00)

Order Part #: P-25-35077-00

(Replaces Carrier #: 25-35077-00)

Order Part #: P-25-35690-00

(Replaces Carrier #: 25-35690-00)

Order Part #: P-25-39015-00

(Replaces Carrier #: 25-39015-00)

### 69TV

Order Part #: P-25-37107-00

(Replaces Carrier #: 25-37107-00)

Order Part #: P-25-15004-00

(Replaces Carrier #: 25-15004-00)

Order Part #: P-25-34006-00

(Replaces Carrier #: 25-34006-00)

Order Part #: P-25-35077-00

(Replaces Carrier #: 25-35077-00)

Order Part #: P-25-35690-00

(Replaces Carrier #: 25-35690-00)

Order Part #: P-25-39015-00

(Replaces Carrier #: 25-39015-00)

### 44TV & 29TV

Order Part #: P-25-34006-00

(Replaces Carrier #: 25-34006-00)

Order Part #: P-25-34016-00

(Replaces Carrier #: 25-34016-00)

Order Part #: P-25-34017-00

(Replaces Carrier #: 25-34017-00)

Order Part #: P-25-35690-00

(Replaces Carrier #: 25-35690-00)

Order Part #: P-25-36027-01

(Replaces Carrier #: 25-36027-01)

### 37

Order Part #: P-25-34006-00

(Replaces Carrier #: 25-34006-00)

Order Part #: P-25-35690-00

(Replaces Carrier #: 25-35690-00)

Order Part #: P-25-36027-01

(Replaces Carrier #: 25-36027-01)



### Plug, Glow (M10 Slow Glow) (91TV)

Order Part #: P-25-15325-00

(Replaces Carrier #: 25-15325-00)



### Plug, Glow (114IDI & 114TV)

Order Part #: P-25-37614-10

(Replaces Carrier #: 25-37614-10)



### Plug, Glow (44TV & 37)

Order Part #: P-25-36482-01

(Replaces Carrier #: 25-36482-01)

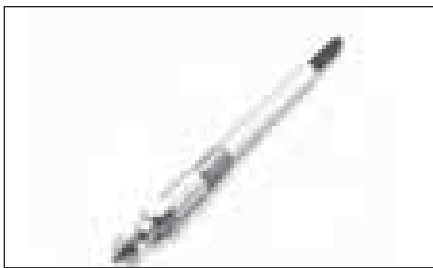

### Plug, Glow (134DI, 114DI & 133DI)

Order Part #: P-25-38150-01

(Replaces Carrier #: 25-38150-01)



### Plug, Glow (134TV and 114TV)

Order Part #: P-25-39155-00

(Replaces Carrier #: 25-39155-00)

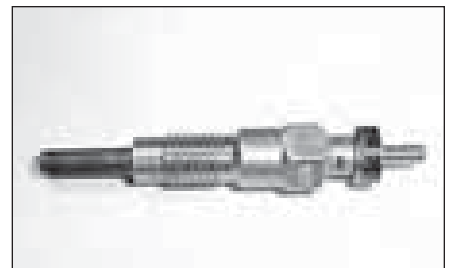

### Plug, Glow (44TV & 29TV)

Order Part #: P-7103921

(Replaces Carrier #: 7103921)

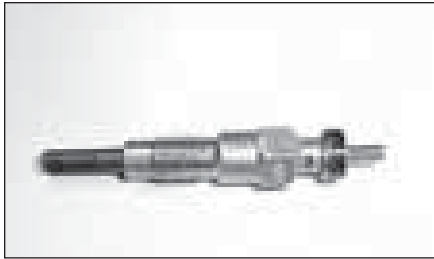

**Plug, Glow (M8 Fast Glow)  
(91TV and 69TV)**

Order Part #: P-25-15330-00  
(Replaces Carrier #: 25-15330-00)

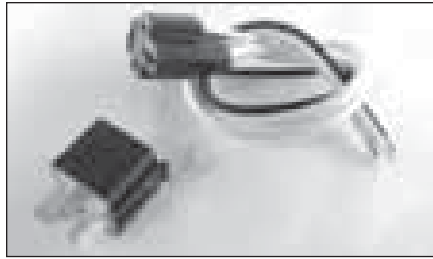

**Glow Plug Kit**

Order Part #: P-76-50033-00  
(Replaces Carrier #: 76-50033-00)



**Pump, Fuel Assembly  
(Mechanical)**

Order Part #: P-25-38666-00  
(Replaces Carrier #: 25-38666-00)



**Pump, Oil w/gasket  
(29TV & 44TV)**

Order Part #: P-25-34021-00-B  
(Replaces Carrier #: 25-34021-00)



**Gasket, Oil Pump  
(29TV & 44TV)**

Order Part #: P-25-34022-00  
(Replaces Carrier #: 25-34022-00)



**Pump, Priming**

Order Part #: P-25-38666-11  
(Replaces Carrier #: 25-38666-11)



**Pump, Oil**

Order Part #: P-25-15040-00  
(Replaces Carrier #: 25-15040-00)

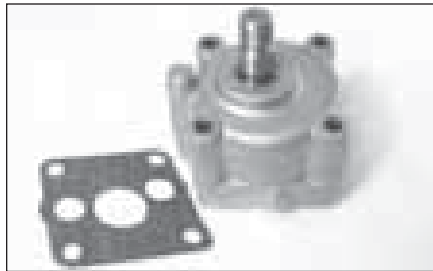

**Pump, Oil w/gasket  
(CT4 engines, except 91)**

Order Part #: P-25-37040-00-B  
(Replaces Carrier #: 25-37040-00)

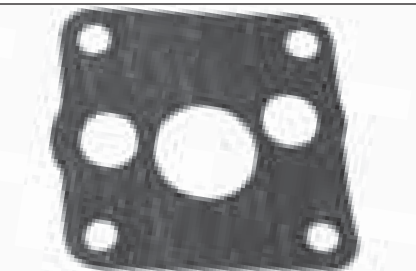

**Gasket, Oil Pump  
(CT4 engines, except 91)**

Order Part #: P-25-37041-00  
(Replaces Carrier #: 25-37041-00)



**Pump, Water w/gasket  
(91TV)**

Order Part #: P-25-15425-00SV  
(Replaces Carrier #: 25-15425-00SV)

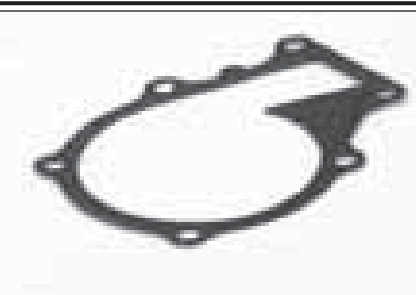

**Gasket, Water Pump  
(91TV)**

Order Part #: P-25-15426-00  
(Replaces Carrier #: 25-15426-00)

# Truck & Trailer Parts – ENGINE

ENGINE

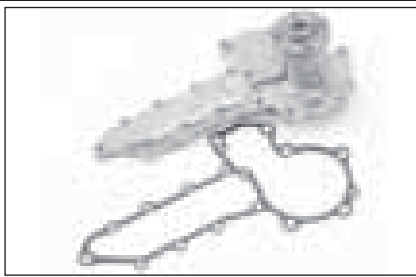

**Pump, Water w/gasket  
(CT4 engines, except 91TV)**

Order Part #: P-25-37581-10-B  
(Replaces Carrier #: 25-37581-10)

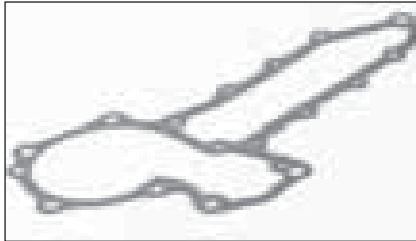

**Gasket, Water Pump  
(CT4 engines, except 91TV)**

Order Part #: P-25-37574-00  
(Replaces Carrier #: 25-37574-00)

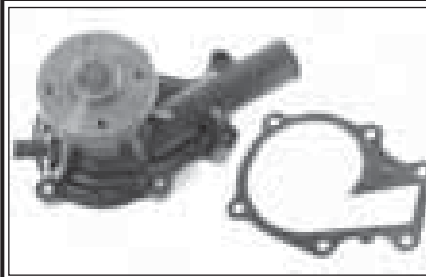

**Pump, Water w/gasket  
(69TV)**

Order Part #: P-29-70183-00SVB  
(Replaces Carrier #: 29-70183-00SV)

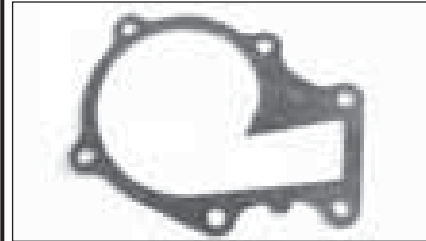

**Gasket, Water Pump  
(69TV)**

Order Part #: P-29-70188-00  
(Replaces Carrier #: 29-70188-00)

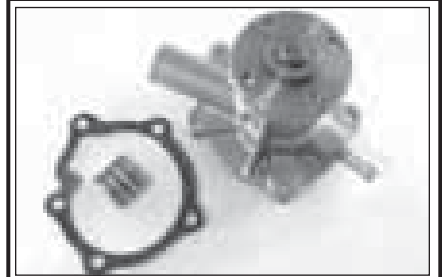

**Pump, Water w/gasket  
(29TV)**

Order Part #: P-25-34935-00SV  
(Replaces Carrier #: 25-34935-00SV)

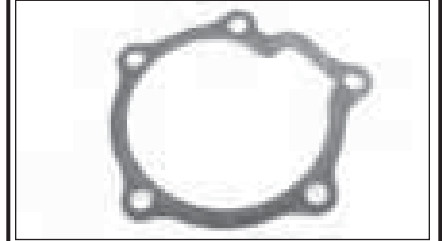

**Gasket, Water Pump  
(29TV)**

Order Part #: P-25-34317-00  
(Replaces Carrier #: 25-34317-00)



**Pump, Water w/gasket  
(44TV)**

Order Part #: P-25-34330-00SVB  
(Replaces Carrier #: 25-34330-00SV)

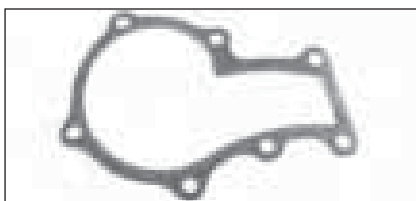

**Gasket, Water Pump  
(44TV)**

Order Part #: P-25-34333-00  
(Replaces Carrier #: 25-34333-00)

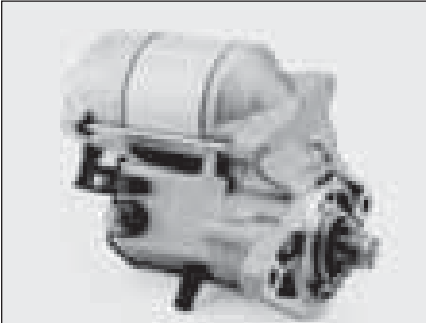

**Starter**

Order Part #: P-25-15520-00  
(Replaces Carrier #: 25-15520-00)



**Starter**

Order Part #: P-25-35465-00  
(Replaces Carrier #: 25-35465-00)



**Starter**

Order Part #: P-25-34885-00  
(Replaces Carrier #: 25-34885-00)

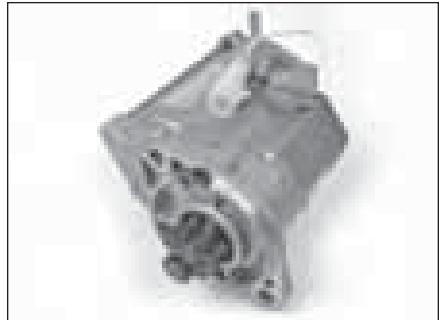

**Starter (2.0 Kw)**

Order Part #: P-25-39291-00-B  
(Replaces Carrier #: 25-39291-00)

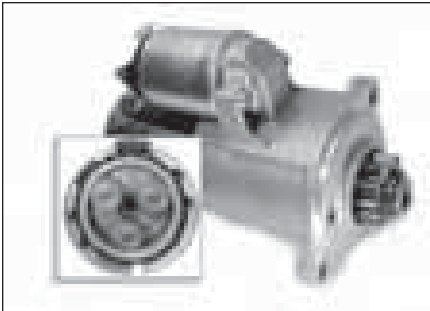

**Starter (Planetary Gear Reduction)**

Order Part #: P-25-38750-00PG  
(Replaces Carrier #: 25-38750-00)

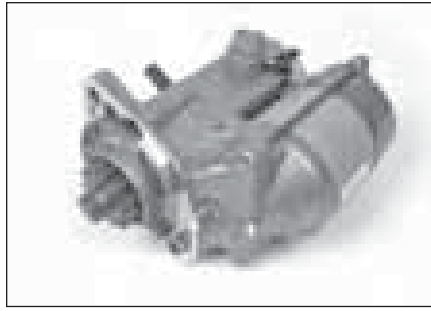

**Starter, 1 pc Oil Pan**

Order Part #: P-25-38750-00  
(Replaces Carrier #: 25-38750-00)

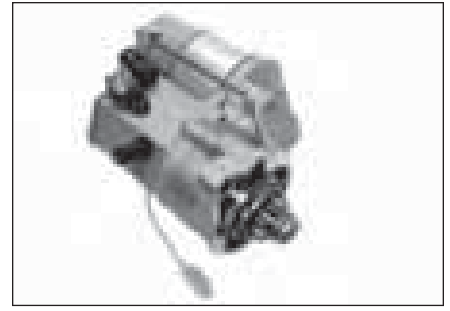

**Starter**

Order Part #: P-29-70158-00  
(Replaces Carrier #: 29-70158-00)

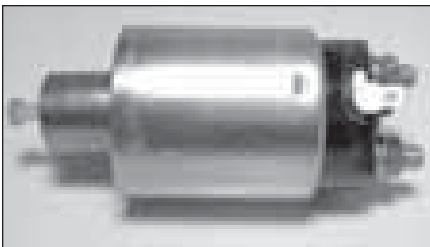

**Solenoid, Starter**

Order Part #: P-25-34893-00  
(Replaces Carrier #: 25-34893-00)

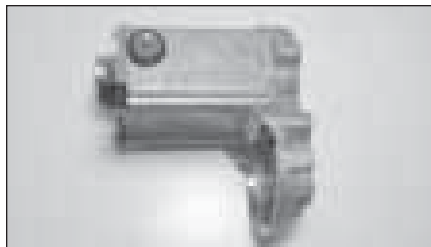

**Solenoid, Starter**

Order Part #: P-25-35466-00  
(Replaces Carrier #: 25-35466-00)



**Solenoid, Speed**

Order Part #: P-10-01178-02SV  
(Replaces Carrier #: 10-01178-02SV)



**Solenoid, Speed**

Order Part #: P-10-60018-00SV  
(Replaces Carrier #: 10-60018-00SV)

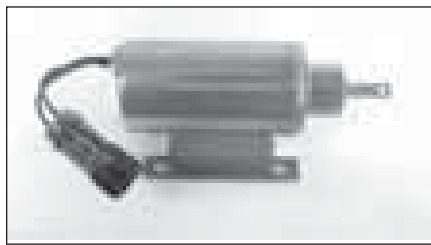

**Solenoid, Speed**

Order Part #: P-10-01179-00  
(Replaces Carrier #: 10-01179-00)



**Boot Kit, Solenoid**

Order Part #: P-10-01178-21  
(Replaces Carrier #: 10-01178-21)



**Boot, Solenoid**

Order Part #: P-58-50006-00  
(Replaces Carrier #: 58-50006-00)



**3M TEMPERATURE LOGGER**  
*Accurate temperature monitoring for fresh loads*  
**Starter Kit Part # 2041853**

# Truck & Trailer Parts – ENGINE

ENGINE

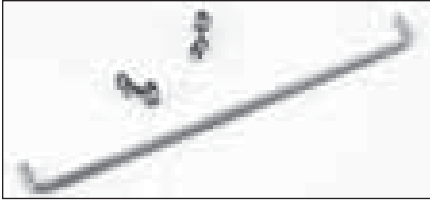

**Rod, Linkage Kit**

Order Part #: P-73-00324-03SV  
(Replaces Carrier #: 73-00324-03SV)



**Clip, Speed (Left Side)**

Order Part #: P-44-01049-01  
(Replaces Carrier #: 44-01049-01)



**Clip, Speed (Right Side)**

Order Part #: P-44-01049-00  
(Replaces Carrier #: 44-01049-00)

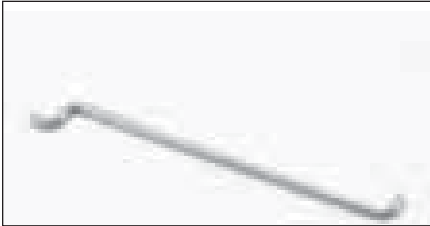

**Rod, Linkage**

Order Part #: P-73-00150-00  
(Replaces Carrier #: 73-00150-00)

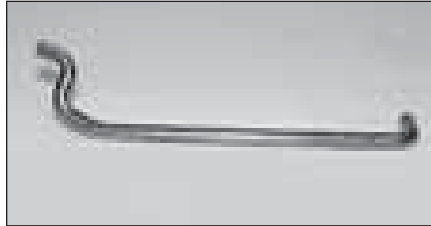

**Rod, Stop Linkage**

Order Part #: P-73-60004-00  
(Replaces Carrier #: 73-60004-00)

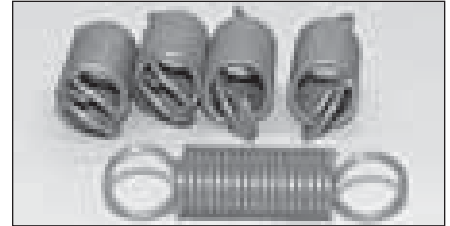

**Spring, Stop Control**

Order Part #: P-73-60005-00  
(Replaces Carrier #: 73-60005-00)



**Rod**

Order Part #: P-30-60031-01  
(Replaces Carrier #: 30-60031-01)



**Rod**

Order Part #: P-7102167  
(Replaces Carrier #: 7102167)



**Rod, Speed Control**

Order Part #: P-30-60030-00  
(Replaces Carrier #: 30-60030-00)



**Rod, Linkage Speed**

Order Part #: P-73-00333-00  
(Replaces Carrier #: 73-00333-00)



**Rod, Linkage Speed**

Order Part #: P-73-00332-00  
(Replaces Carrier #: 73-00332-00)

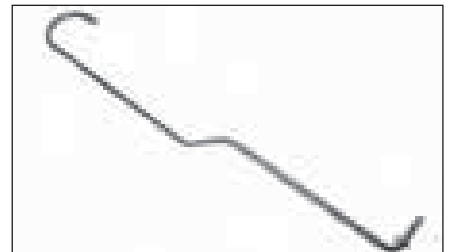

**Rod, Linkage, Speed**

Order Part #: P-73-00312-00  
(Replaces Carrier #: 73-00312-00)

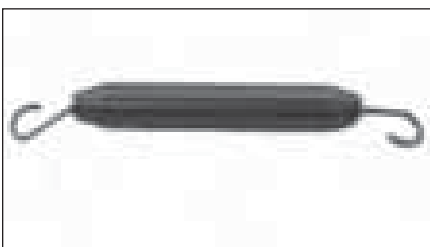

**Spring**

Order Part #: P-73-00145-01  
(Replaces Carrier #: 73-00145-01)

**Spring, Start**

Order Part #: P-29-70216-00  
(Replaces Carrier #: 29-70216-00)

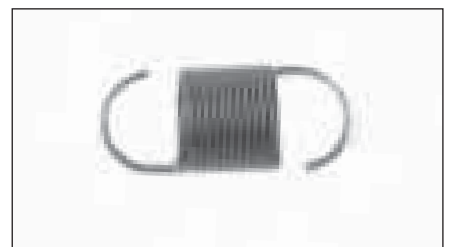

## Truck & Trailer Parts – ENGINE

ENGINE

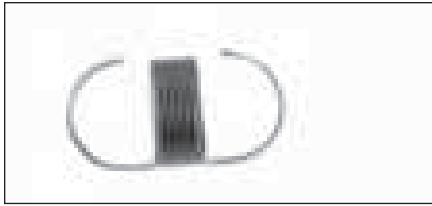

### Spring, Start

Order Part #: P-25-34265-01  
(Replaces Carrier #: 25-34265-01)



### Spring, Governor

Order Part #: P-25-34275-00  
(Replaces Carrier #: 25-34275-00)

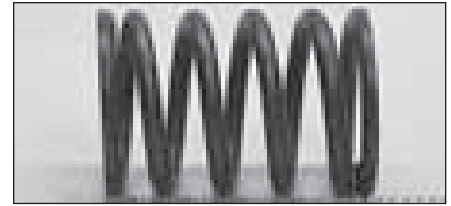

### Spring, Valve

Order Part #: P-25-34112-00  
(Replaces Carrier #: 25-34112-00)

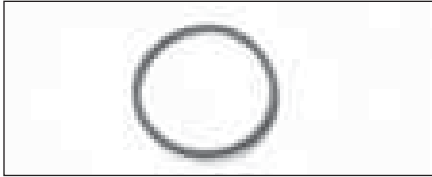

### Seal, O-Ring

Order Part #: P-25-37599-00  
(Replaces Carrier #: 25-37599-00)

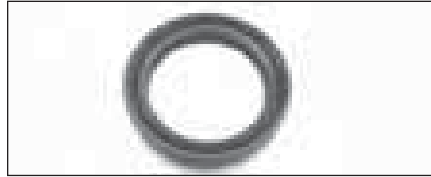

### Seal, Oil

Order Part #: P-25-15055-00  
(Replaces Carrier #: 25-15055-00)

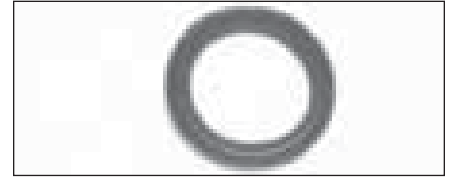

### Seal, Oil (Front)

Order Part #: P-25-34069-00-B  
(Replaces Carrier #: 25-34069-00)

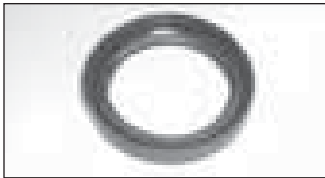

### Seal, Oil (Front)

Order Part #: P-25-37396-01-B  
(Replaces Carrier #: 25-37396-01)

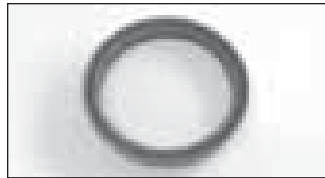

### Seal, Oil (Rear)

Order Part #: P-25-37197-00-B  
(Replaces Carrier #: 25-37197-00)

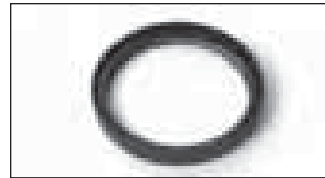

### Seal, Oil (Rear)

Order Part #: P-25-35182-05  
(Replaces Carrier #: 25-35182-05)

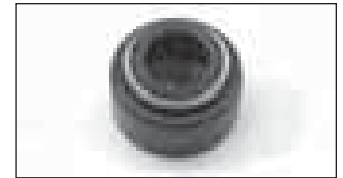

### Seal, Valve Stem

Order Part #: P-25-15465-00-B  
(Replaces Carrier #: 25-15465-00)

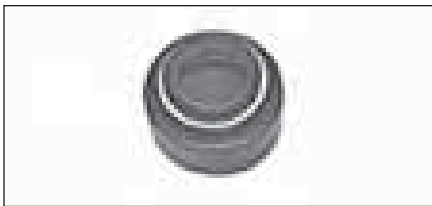

### Seal, Valve Stem

Order Part #: P-25-37265-00  
(Replaces Carrier #: 25-37265-00)



### Sleeve, Wear (Front)

Order Part #: P-25-34173-00  
(Replaces Carrier #: 25-34173-00)



### Sleeve, Wear (Front)

Order Part #: P-25-37388-00-B  
(Replaces Carrier #: 25-37388-00)



### Sleeve, Wear (Rear)

Order Part #: P-25-15152-00  
(Replaces Carrier #: 25-15152-00)



### Sleeve, Wear (Rear)

Order Part #: P-25-37385-02-B  
(Replaces Carrier #: 25-37382-02)



### Sleeve, Wear

Order Part #: P-25-35420-11  
(Replaces Carrier #: 25-35420-11)

## Truck & Trailer Parts – ENGINE

ENGINE

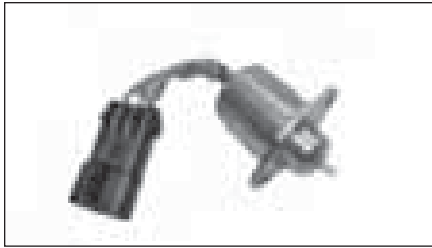

### Solenoid, Fuel Shut Off (91TV/69TV)

Order Part #: P-25-15230-01  
(Replaces Carrier #: 25-15230-01)



### Solenoid, Injection Pump (2-piece oil pan)

Order Part #: P-25-38109-05SV  
(Replaces Carrier #: 25-38109-05SV)



### Thermostat, Water w/o gasket (29TV, 44TV, 69TV, 91TV)

Order Part #: P-25-34309-01  
(Replaces Carrier #: 25-34309-01)

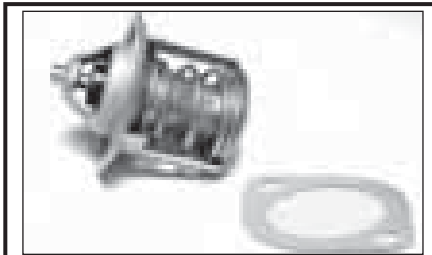

### Thermostat, Water w/gasket (134TV & 114TV)

Order Part #: P-25-39236-01-B  
(Replaces Carrier #: 25-39236-01)



### Valve, Check Fuel

Order Part #: P-30-01105-00SV  
(Replaces Carrier #: 30-01105-00SV)



### Gasket, Thermostat (29TV, 44TV, 69TV, 91TV)

Order Part #: P-25-36676-00  
(Replaces Carrier #: 25-36676-00)



### Thermostat, Water w/gasket (134DI, 114DI, 114IDI & 133DI)

Order Part #: P-25-37559-01  
(Replaces Carrier #: 25-37559-01)

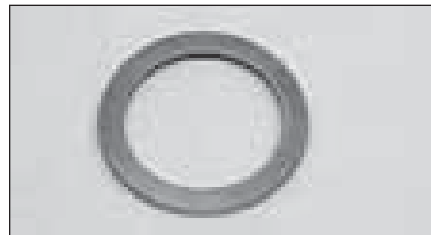

### Washer

Order Part #: P-25-37589-00  
(Replaces Carrier #: 25-37589-00)

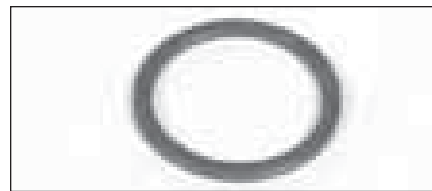

### Washer, Oil Drain

Order Part #: P-25-36739-00  
(Replaces Carrier #: 25-36739-00)



### Gasket, Thermostat (All 4 Cyl except 91TV)

Order Part #: P-25-37558-00  
(Replaces Carrier #: 25-37558-00)

**Our PG Parts™ Remanufactured Engines and Compressors come with a 2-year Thermo King warranty backed by a nationwide dealer network**

## REMANUFACTURED COMPRESSORS

We offer a variety of Carrier compressors for your convenience. To determine the correct model you need, verify the model or part number on the Carrier compressor you are replacing. Carrier compressors come in a number of varieties, with some of the differences not being visually apparent, therefore, it is important for you to verify the model or part number required for your application.

NOTE: Compressors are furnished without oil. Installer must add the proper type and quantity of compressor oil compatible with the specific Carrier refrigeration system being serviced.

### PG Parts Remanufactured Compressors:

- ✓ Our compressors are remanufactured in the same plant as our Genuine Thermo King compressors
- ✓ Each compressor features machined, resurfaced heads for optimal gasket sealing, resulting in longer service life and higher performance
- ✓ Our compressor cylinders are honed with an advanced honing machine to deliver higher capacity performance and reliability resulting in longer ring life and better life of the compressor
- ✓ Compressor specifications match Carrier OEM standards

### The following models are available:

05G 41 CFM with unloaders .....	P-18-00059-72RM
05G 37 CFM ultra-flange .....	P-18-00059-126RM
05G 41CFM ultra-flange .....	P-18-00059-127RM
05G 37 CFM non-ultra flange .....	P-17-44063-00
05G 41 CFM non-ultra flange .....	P-17-44101-01
05G 37 CFM bus .....	P-17-44062-00
05G 41 CFM bus .....	P-17-44065-00
05G 37 CFM 922/944 .....	P-18-00059-130RM
05K 24 CFM .....	P-18-00057-23RM
05K 12 CFM .....	P-18-60000-04RM

### CARRIER 05G NOMENCLATURE

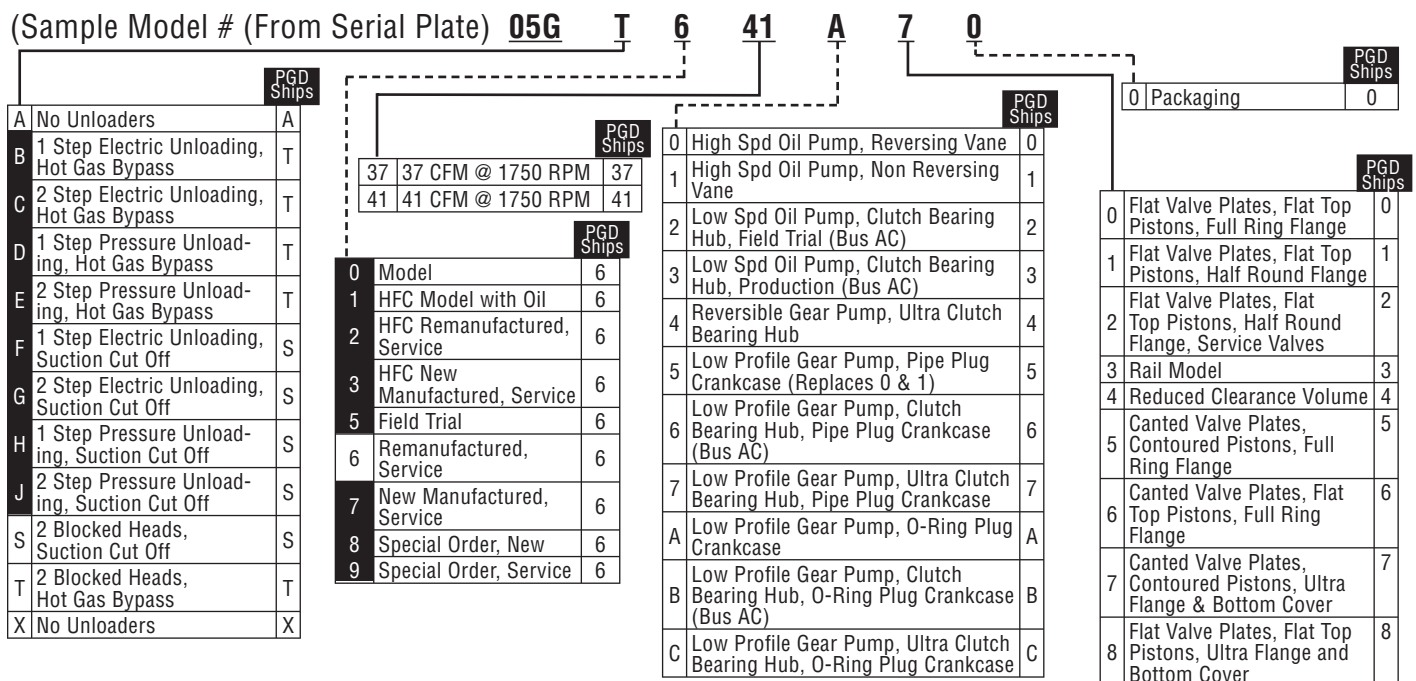

**COMPRESSORS**

**COMPRESSOR**

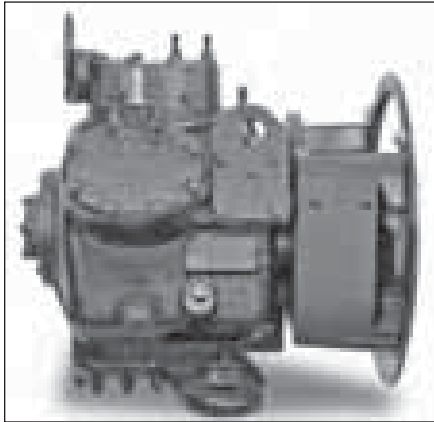

**Compressor, Reman. w/Unloaders**

Order Part #: P-18-00059-72RM  
(Replaces Carrier #: 18-00059-72)

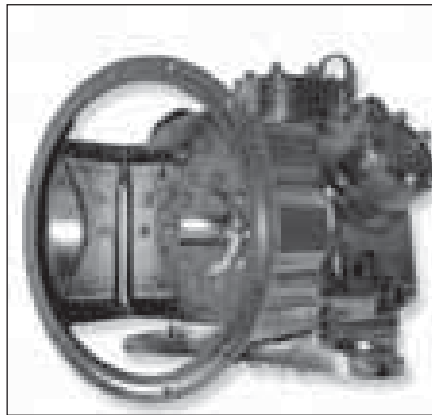

**Compressor, Reman. (05G 37 CFM) Ultra**

Order Part #: P-18-00059-126RM  
(Replaces Carrier #: 18-00059-126)

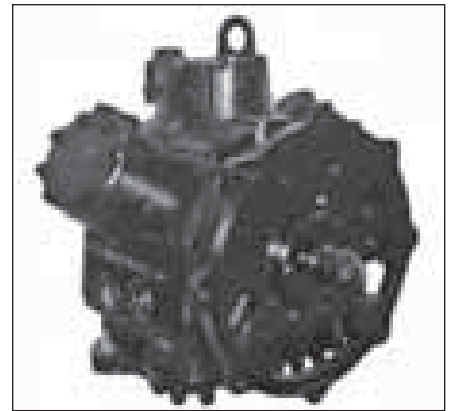

**Compressor, Reman. (05G 37 CFM)**

Order Part #: P-17-44063-00  
(Replaces Carrier #: 17-44063-00)

**Compressor, Reman. (05G 41 CFM) Ultra**

Order Part #: P-18-00059-127RM  
(Replaces Carrier #: 18-00059-127)

**Compressor, Reman. (05G 41 CFM)**

Order Part #: P-17-44101-01  
(Replaces Carrier #: 17-44101-01)

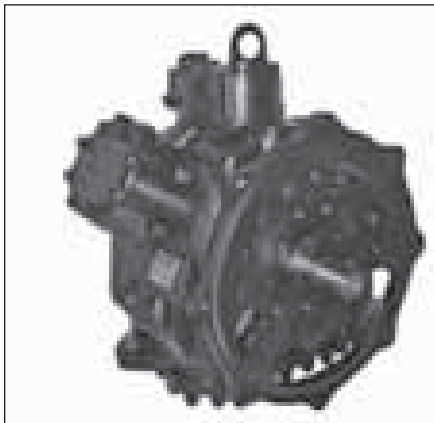

**Compressor, Reman. (05G 37 CFM) 922/944**

Order Part #: P-18-00059-130RM  
(Replaces Carrier #: 18-00059-130)

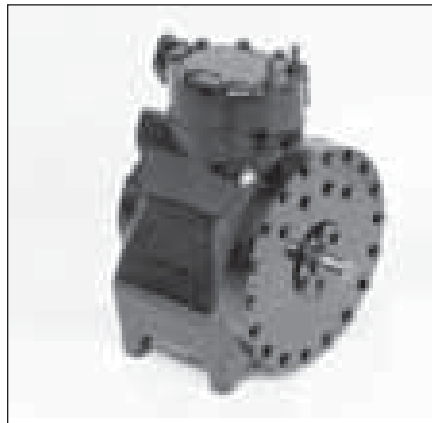

**Compressor, Reman. (05K 12 CFM) 7XX/6XX**

Order Part #: P-18-60000-04RM  
(Replaces Carrier #: 18-60000-04)



**Compressor, Reman. Bus (05G 37 CFM)**

Order Part #: P-17-44065-00RM  
(Replaces Carrier #: 17-44065-00)

**Compressor, Reman. Bus (05G 41 CFM)**

Order Part #: P-17-44062-00RM  
(Replaces Carrier #: 17-44062-00)

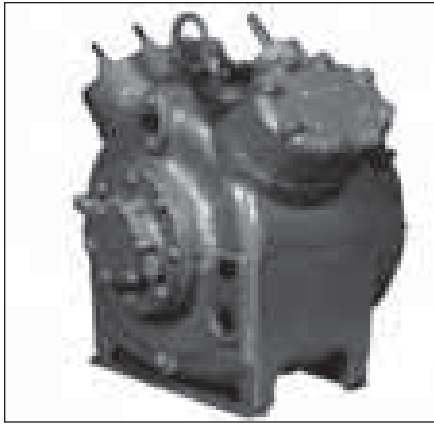

**Compressor, Reman.  
(05K 24 CFM) Optima**  
Order Part #: P-18-00057-23RM  
(Replaces Carrier #: 18-00057-23)

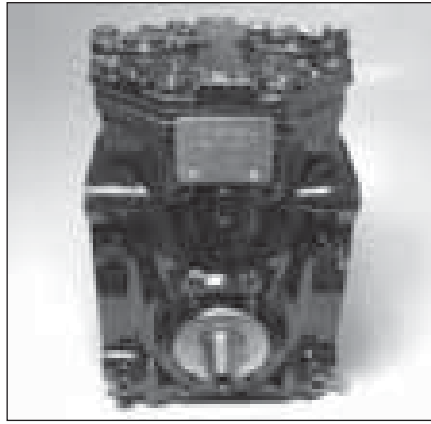

**Compressor Kit Supra 4XX  
(NEW, not remanufactured)**  
Order Part #: P-18-60002-03SV  
(Replaces Carrier #: 18-60002-03SV)



**Covers Kit, 05G**  
(Use to prep compressor for return)  
Order Part #: P-05G-COVERS  
(Replaces Carrier #: 05G-COVERS)

# 05G & 05K

## Remanufactured PG Parts™

### Compressors for your Carrier® units

**We replace the following parts  
with new components:**

- ✓ Valve
- ✓ All gaskets
- ✓ Oil Pump
- ✓ Thrust Washers
- ✓ Rods
- ✓ Valve plates
- ✓ Bearings
- ✓ Shaft seal
- ✓ Pistons
- ✓ Crankshaft\*

\* Replaced as new or remanufactured to OEM specification when necessary

**COMPRESSOR CLEANUP SUPPLIES**

**COMPRESSOR**



**Acid Kit, (POE Oil) Pkg/2**  
Order Part #: P-07-00337-00  
(Replaces Carrier #: 07-00337-00)



**Kit, Acid Test**  
Order Part #: 203-346  
(Replaces Carrier #: 07-00260-00)



**Adapter,  
05K Compressor Filter**  
Order Part #: P-14-60043-00  
(Replaces Carrier #: 14-60043-00)



**Filter Element,  
Suction Acid**  
Order Part #: P-14-50054-00  
(Replaces Carrier #: 14-50054-00)



**Filter Element,  
Suction Pleated**  
Order Part #: P-14-50055-00  
(Replaces Carrier #: 14-50055-00)



**Filter, Sock**  
Order Part #: P-58-04165-00  
(Replaces Carrier #: 58-04165-00)  
**Filter, Sock**  
Order Part #: P-58-00869-00  
(Replaces Carrier #: 58-00869-00)



**Suction Filter Kit,  
Compressor**  
Order Part #: P-07-00379-00  
(Replaces Carrier #: 07-00379-00)



*Stainless Steel Tubes for  
Longer Life than Carrier's*

**Oil Filter Kit, Compressor**  
Order Part #: P-07-00380-00-B  
(Replaces Carrier #: 07-00380-00)

**Filter, Oil  
Compressor**  
(Replacement filter  
for PG kit only)  
Order Part #: 66-7800

**COMPRESSOR COMPONENTS**



**Bearing, Shaft End  
(Unmachined)**

Order Part #: P-17-44015-00  
(Replaces Carrier #: 17-44015-00)



**Cap, Service Valve**

Order Part #: P-17-10812-00  
(Replaces Carrier #: 17-10812-00)



**Crankshaft (05G 37 CFM)  
(Vane Pump Only)**

Order Part #: P-17-44010-00  
(Replaces Carrier #: 17-44010-00)



**Crankshaft (05G 37 CFM)  
(All Gear Pumps)**

Order Part #: P-17-40410-00  
(Replaces Carrier #: 17-40410-00)



**Crankshaft (05G 41 CFM)  
(All Gear Pumps)**

Order Part #: P-17-40412-00  
(Replaces Carrier #: 17-40412-00)



**Gasket, Unloader**

Order Part #: P-17-40104-07  
(Replaces Carrier #: 17-40104-07)

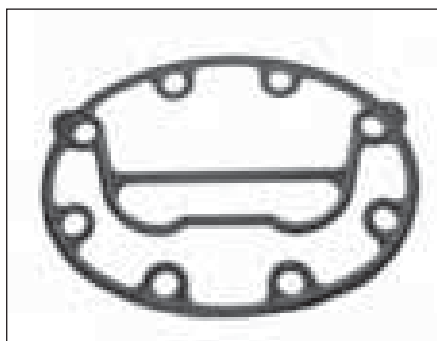

**Gasket, Suction Cutoff  
Unloader Head**

Order Part #: P-17-44125-00  
(Replaces Carrier #: 17-44125-00)

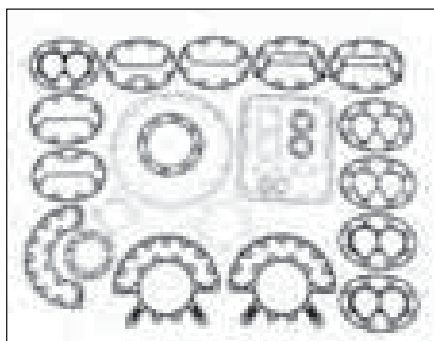

**Gasket Set, Compressor  
(05G)**

Order Part #: P-17-55020-20  
(Replaces Carrier #: 17-55020-20)

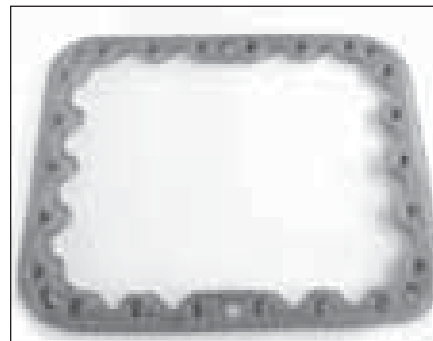

**Gasket, Bottom Plate**

Order Part #: P-17-40033-05  
(Replaces Carrier #: 17-40033-05)

# Truck & Trailer Parts – COMPRESSOR

COMPRESSOR

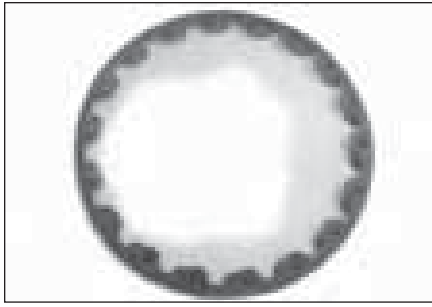

**Gasket, Cover (05D, 06D)**

Order Part #: P-17-40029-05  
(Replaces Carrier #: 17-40029-05)

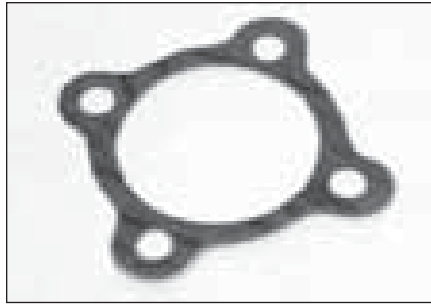

**Gasket, Cover**

Order Part #: P-17-40075-05  
(Replaces Carrier #: 17-40075-05)

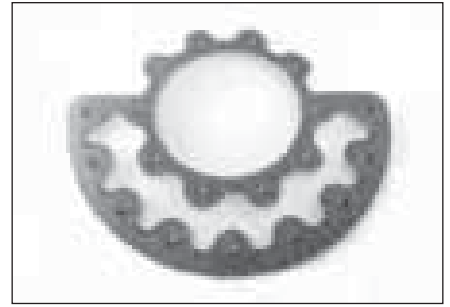

**Gasket, End Plate**

Order Part #: P-17-44119-00  
(Replaces Carrier #: 17-44119-00)

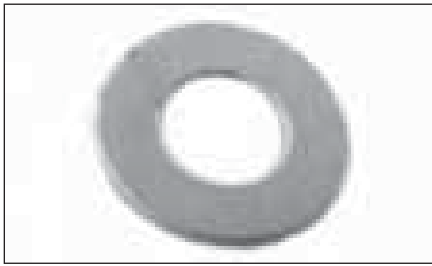

**Gasket, Flange**

Order Part #: P-17-44014-00  
(Replaces Carrier #: 17-44014-00)

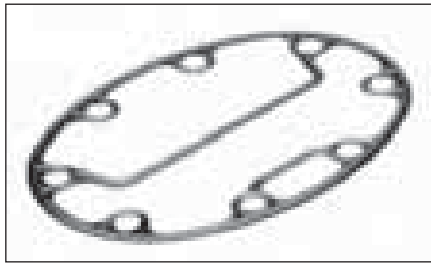

**Gasket, Head Center**

Order Part #: P-17-44123-00  
(Replaces Carrier #: 17-44123-00)

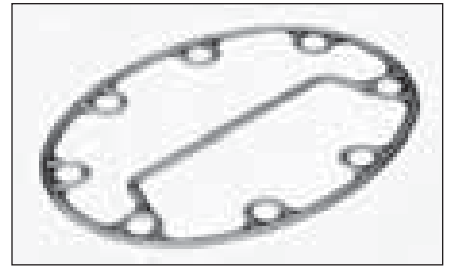

**Gasket, Head w/o Unloaders**

Order Part #: P-17-44124-00  
(Replaces Carrier #: 17-44124-00)

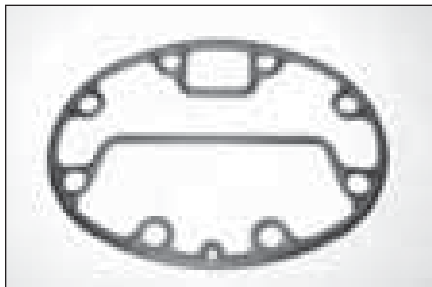

**Gasket, Head**

Order Part #: P-17-44126-00  
(Replaces Carrier #: 17-44126-00)

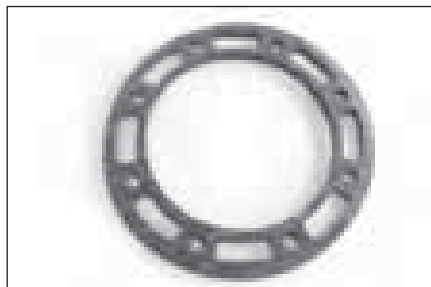

**Gasket, Pump End**

Order Part #: P-17-40078-05  
(Replaces Carrier #: 17-40078-05)

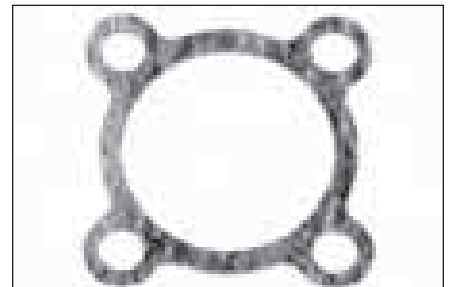

**Gasket, Service Valve (Suction)**

Order Part #: P-17-40005-05  
(Replaces Carrier #: 17-40005-05)

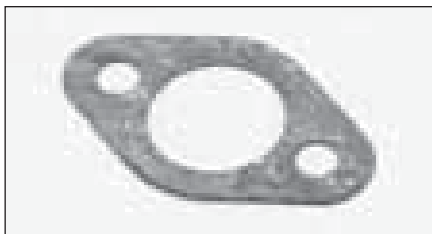

**Gasket, Service Valve (Discharge) Fiber**

Order Part #: P-17-44138-00  
(Replaces Carrier #: 17-44138-00)



**Gasket, Service Valve (05K) (Discharge)**

Order Part #: P-17-21003-00  
(Replaces Carrier #: 17-21003-00)

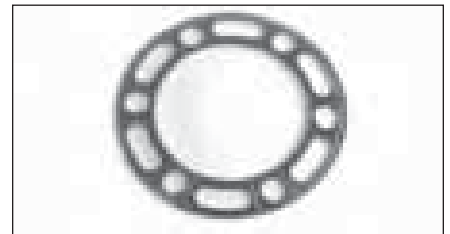

**Gasket, Shaft Seal (Fiber)**

Order Part #: P-17-44004-06  
(Replaces Carrier #: 17-44004-06)

## Truck & Trailer Parts – COMPRESSOR

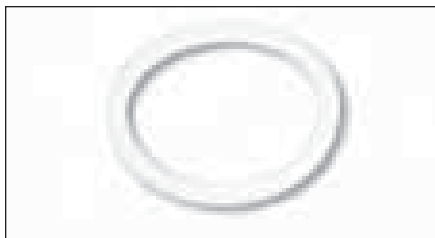

### Gasket, Sight Glass

Order Part #: P-17-10218-02  
(Replaces Carrier #: 17-10218-02)

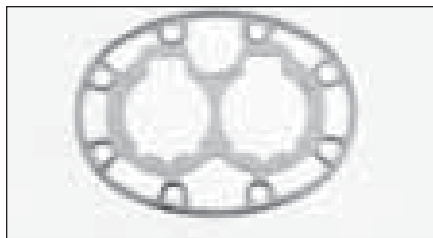

### Gasket, Valve Plate (05G) (Metal)

Order Part #: P-17-44007-06  
(Replaces Carrier #: 17-44007-06)

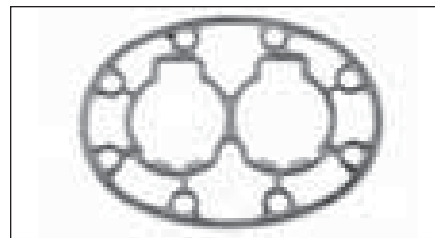

### Gasket, Valve Plate (05K) (Metal)

Order Part #: P-17-55002-00  
(Replaces Carrier #: 17-55002-00)

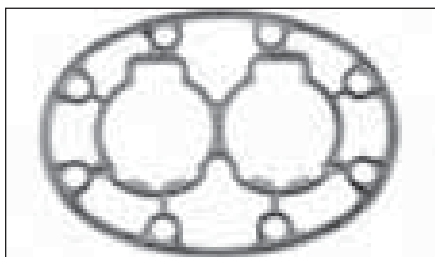

### Gasket, Valve Plate (05K) (Metal)

Order Part #: P-17-55002-00  
(Replaces Carrier #: 17-55002-00)



### Head, Cylinder (05G) HGBP Unloader

Order Part #: P-17-40104-05  
(Replaces Carrier #: 17-40104-05)



### Flange, Ultra

Order Part #: P-17-44025-00  
(Replaces Carrier #: 17-44025-00)



### Sump, Ultra

Order Part #: P-17-44026-00  
(Replaces Carrier #: 17-44026-00)

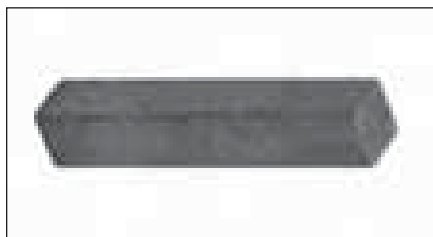

### Key, Crankshaft (05G)

Order Part #: P-17-40324-00  
(Replaces Carrier #: 17-40324-00)

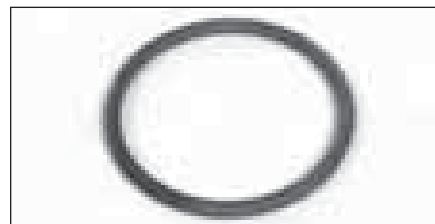

### O-Ring

Order Part #: 33-230  
(Replaces Carrier #: 17-44043-02)

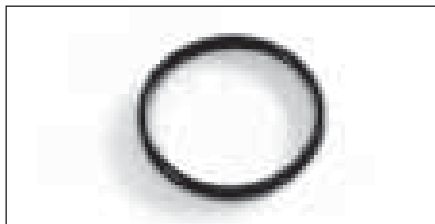

### O-Ring

Order Part #: P-17-55022-00  
(Replaces Carrier #: 17-55022-00)



### O-Ring, Oil Tube

Order Part #: P-42-00243-09  
(Replaces Carrier #: 42-00243-09)



### Oil, Comp (Alkylbenzene)

Order Part #: 67-404 (Case)  
(Replaces Carrier #: 07-00274-00)

## Truck & Trailer Parts – COMPRESSOR

COMPRESSOR

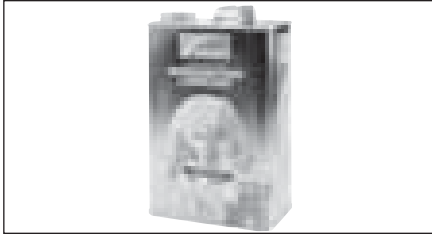

**Oil, Comp (Polyolester)**  
Order Part #: P-07-00317-00  
(Replaces Carrier #: 07-00317-00)

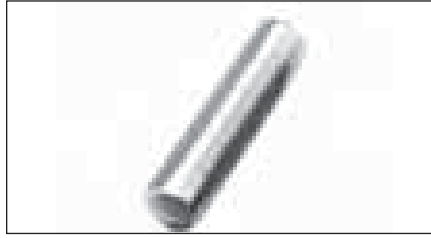

**Pin Dowel**  
Order Part #: P-17-40057-00  
(Replaces Carrier #: 17-40057-00)

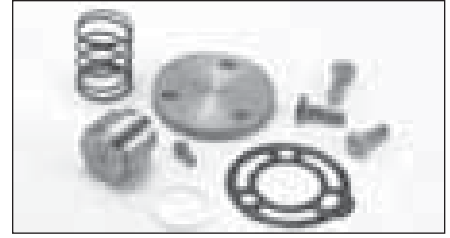

**Plug Kit Unloader**  
Order Part #: P-17-55013-00  
(Replaces Carrier #: 17-55013-00)



**Piston, Flat  
37 CFM (Std)**  
Order Part #: P-17-44045-01  
(Replaces Carrier #: 17-44045-01)



**Piston, 37 CFM  
Contour Head (Std)**  
Order Part #: P-17-44016-05  
(Replaces Carrier #: 17-44016-05)



**Piston, 2 Ring, 41 CFM  
Cont Head (Std)**  
Order Part #: P-17-44115-01  
(Replaces Carrier #: 17-44115-01)

**Piston, Flat  
37 CFM (+.020")**  
Order Part #: P-17-44045-03  
(Replaces Carrier #: 17-44045-03)

**Piston, 37 CFM  
Contour Head (+.020")**  
Order Part #: P-17-44016-07  
(Replaces Carrier #: 17-44016-07)

**Piston, 2 Ring, 41 CFM  
Cont Head (+.020")**  
Order Part #:  
(Replaces Carrier #: 17-44115-20)



**Piston, Flat  
37 CFM (Std)**  
Order Part #: P-17-44045-01  
(Replaces Carrier #: 17-44045-01)



**Piston, 37 CFM  
Contour Head (Std)**  
Order Part #: P-17-44016-05  
(Replaces Carrier #: 17-44016-05)



**Piston, 2 Ring, 41 CFM  
Cont Head (Std)**  
Order Part #: P-17-44115-01  
(Replaces Carrier #: 17-44115-01)

**Piston, Flat  
37 CFM (+.020")**  
Order Part #: P-17-44045-03  
(Replaces Carrier #: 17-44045-03)

**Piston, 37 CFM  
Contour Head (+.020")**  
Order Part #:  
(Replaces Carrier #: 17-44016-07)

**Piston, 2 Ring, 41 CFM  
Cont Head (+.020")**  
Order Part #: P-17-44115-20  
(Replaces Carrier #: 17-44115-20)



**Pump, Oil (Universal Gear)**  
Order Part #: P-17-44137-00  
(Replaces Carrier #: 17-44137-00)

**Pump, Oil (Vane)**  
Order Part #: P-17-40200-02  
(Replaces Carrier #: 17-40200-02)

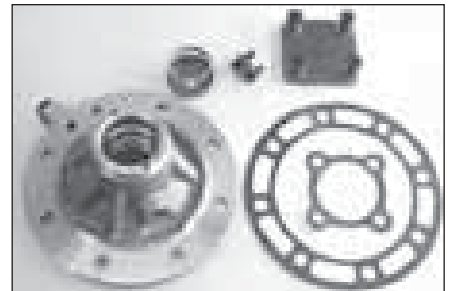

## Truck & Trailer Parts – COMPRESSOR

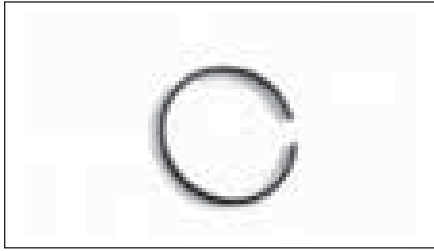

**Ring, Oil** (only for older 37 cfm pistons with wider lower groove)  
Order Part #: P-17-40054-00  
(Replaces Carrier #: 17-40054-00)

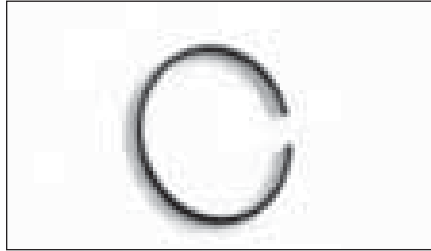

**Ring, Piston (05G) (Std.)**  
Order Part #: P-17-40055-00  
(Replaces Carrier #: 17-40055-00)

**Ring, Piston (05G) (+.020")**  
Order Part #: P-17-55025-00  
(Replaces Carrier #: 17-55025-00)



**Rod, Connecting (Std)**  
Order Part #: P-17-40056-02  
(Replaces Carrier #: 17-40056-02)

**Rod, Connecting (+.010")**  
Order Part #: P-17-55023-00  
(Replaces Carrier #: 17-55023-00)

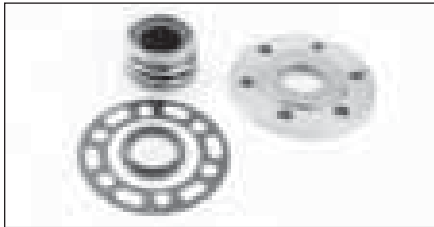

**Seal, Compressor (05K)**  
Order Part #: P-17-44740-00  
(Replaces Carrier #: 17-44740-00)

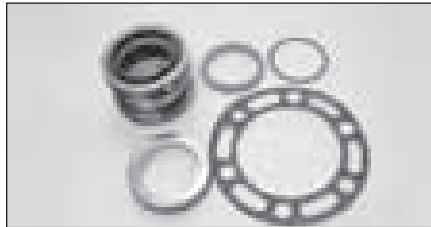

**Seal, Shaft (05G w/Elec Stby)**  
Order Part #: P-17-44150-00  
(Replaces Carrier #: 17-44150-00)

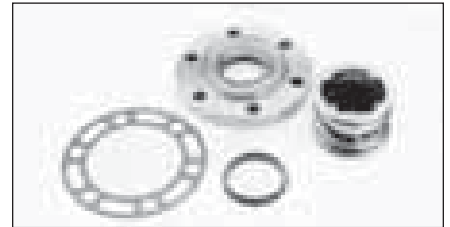

**Seal, Shaft (05D)**  
Order Part #: P-17-44135-00  
(Replaces Carrier #: 17-44135-00)

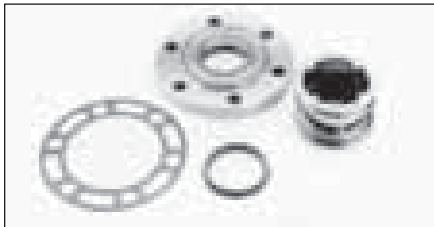

**Seal, Shaft (05G)**  
Order Part #: P-17-44145-00  
(Replaces Carrier #: 17-44145-00)



**Sightglass**  
Order Part #: P-17-10218-00  
(Replaces Carrier #: 17-10218-00)

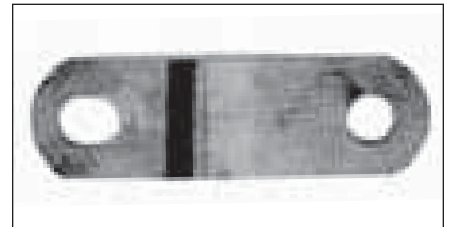

**Spring, Suction Valve**  
Order Part #: P-17-40083-00  
(Replaces Carrier #: 17-40083-00)



**Screen, Oil Filter (05G)**  
Order Part #: P-17-40020-00  
(Replaces Carrier #: 17-40020-00)

# Truck & Trailer Parts – COMPRESSOR

COMPRESSOR

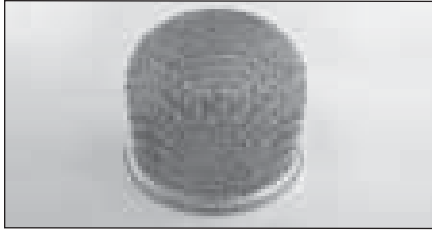

**Strainer, Suction (05G)**  
 Order Part #: P-17-44005-00  
 (Replaces Carrier #: 17-44005-00)

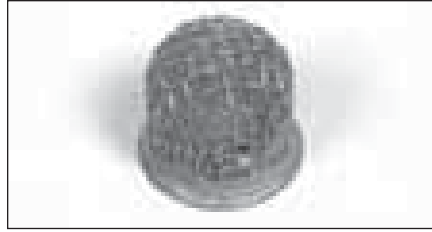

**Strainer, Suction (05G)**  
 Order Part #: P-17-44716-00  
 (Replaces Carrier #: 17-44716-00)

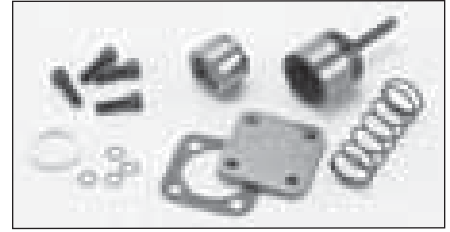

**Suction Cutoff Unloader Repair Kit**  
 Order Part #: P-17-21055-00  
 (Replaces Carrier #: 17-21055-00)

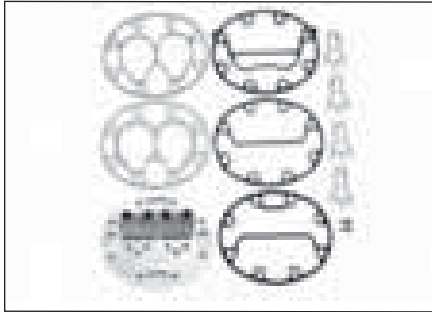

**Valve Plate (Canted, Center or Side Bank)**  
 Order Part #: P-17-44105-00  
 (Replaces Carrier #: 17-44105-00)

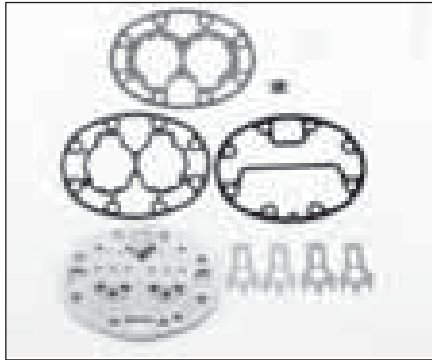

**Valve Plate (Canted, Side Bank w/HGBP)**  
 Order Part #: P-17-44104-00  
 (Replaces Carrier #: 17-44104-00)

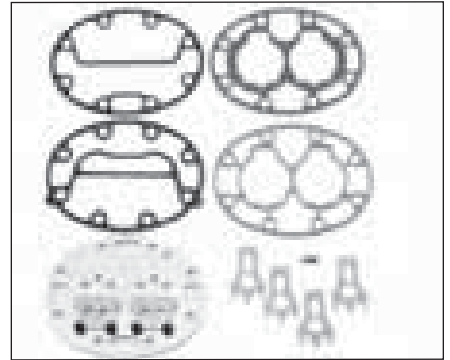

**Valve Plate (Flat, Ctr or Side w/Suc.Cutoff)**  
 Order Part #: P-17-44107-00  
 (Replaces Carrier #: 17-44107-00)

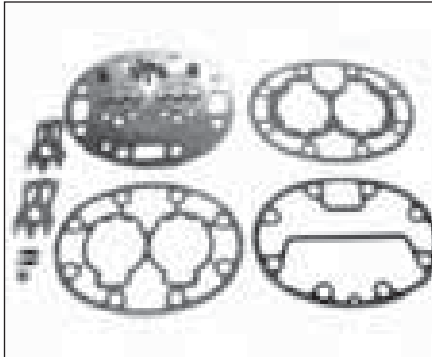

**Valve Plate (Flat, Side Bank w/HGBP)**  
 Order Part #: P-17-44106-00  
 (Replaces Carrier #: 17-44106-00)

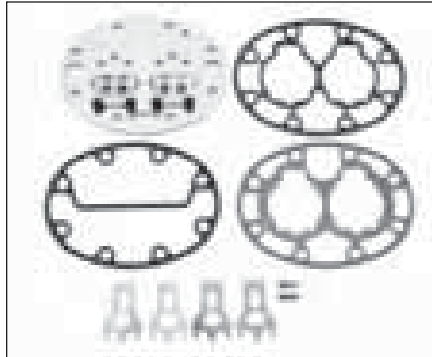

**Valve Plate (Flat, Side Bank w/no unload)**  
 Order Part #: P-17-44099-00  
 (Replaces Carrier #: 17-44099-00)

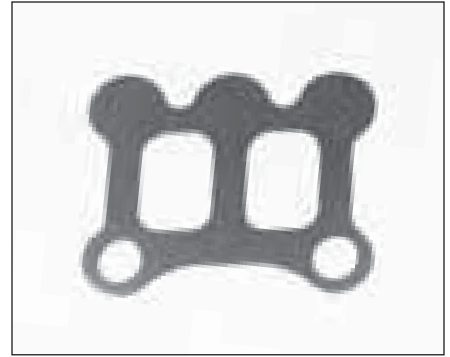

**Valve, Discharge**  
 Order Part #: P-17-40086-00  
 (Replaces Carrier #: 17-40086-00)

## Truck & Trailer Parts – COMPRESSOR



### Valve, Suction (05G)

Order Part #: P-17-44111-00  
(Replaces Carrier #: 17-44111-00)

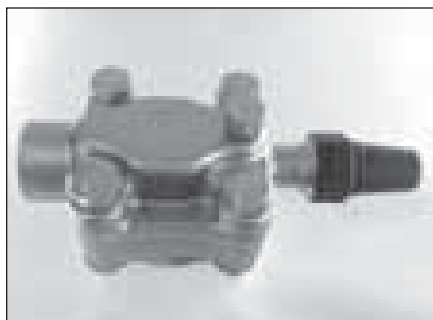

### Valve, Service Suction

Order Part #: P-17-40002-01  
(Replaces Carrier #: 17-40002-01)



### Valve, Service 7/8"

Order Part #: P-14-01042-04  
(Replaces Carrier #: 14-01042-04)

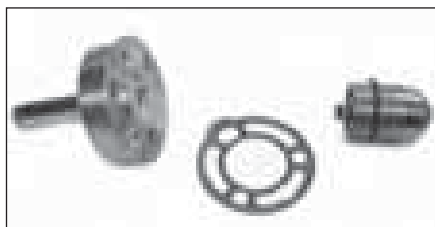

### Valve, Unloader

Order Part #: P-17-40417-00  
(Replaces Carrier #: 17-40417-00)

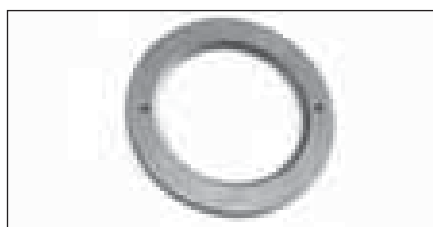

### Washer, Thrust (Pump End)

Order Part #: P-17-55009-01  
(Replaces Carrier #: 17-55009-01)

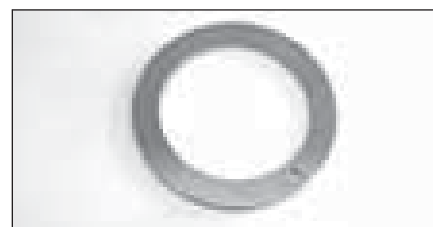

### Washer, Thrust (Seal End)

Order Part #: P-17-44008-00  
(Replaces Carrier #: 17-44008-00)

COMPRESSOR

## EON Power Pack

*Auxiliary lighting power supply.*

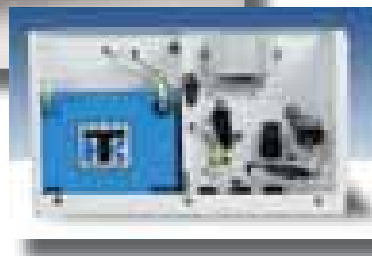

### Economical auxiliary power for operating lights

- Avoid dead truck batteries
- Powered by a long-lasting EON battery
- Easy to install
- Weatherproof enclosure

#### KIT INCLUDES:

- Low voltage disconnect to maximize battery life
- Charging circuit to connect system to reefer or truck alternator

#### Available Option:

- Weatherproof switch with integrated 45-minute timer

# Espar Airtronic® D2/D4 Air Heaters

For comfortable truck cab and sleeper heat  
without engine idling

## Choose Espar Cab and Sleeper Heat from Thermo King

- Reduce fuel, engine idling and maintenance costs
- Automatic heat regulation through four heat levels
- Low fuel and electrical power consumption
- Self-diagnostics

### Espar Kit Options

(each kit includes heater)

#### AIRTRONIC 2 TRUCK KITS

(all kits below include harness, fuel system, ducting, mounting bracket, control option/timer, fuel pickup pipe, hardware kit, exhaust and intake pipes unless otherwise noted)

12 volt with mini-controller.....	840837
12 volt with thermostat .....	840838
12 volt with mini-controller and 90° outlet hood.....	840839
12 volt with 7-day timer.....	840842
12 volt with mini-controller (no fuel pickup pipe).....	800110
12 volt with thermostat (no fuel pickup pipe).....	800111
24 volt with thermostat .....	840841

#### AIRTRONIC 4 TRUCK KITS

(all kits below include harness, fuel system, ducting, mounting bracket, control option/timer, fuel pickup pipe, hardware kit, exhaust and intake pipes)

12 volt with mini-controller .....	840846
12 volt with thermostat .....	840847

#### AIRTRONIC 2

12 volt basic heater only.....	840843
24 volt basic heater only.....	840844

#### AIRTRONIC 4

12 volt basic heater only.....	840849
24 volt basic heater only.....	840850

Gasoline versions also available.

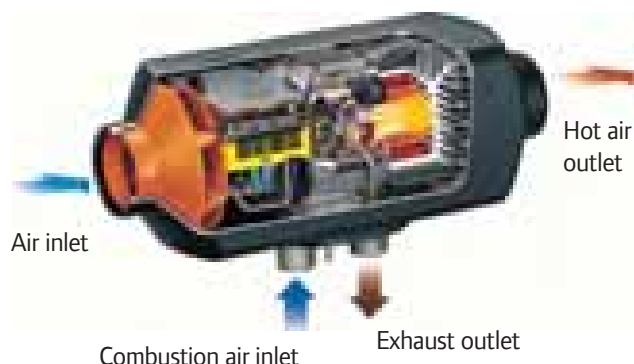

Airtronic D2	Airtronic D4
<b>Heat Output</b> BTU/hr(KW)	<b>Heat Output</b> BTU/hr(KW)
7500 (2.2) Boost	13,600 (4.0) Boost
6150 (1.8) High	10,200 (3.0) High
4100 (1.2) Medium	6,800 (2.0) Medium
2900 (0.8) Low	3,400 (1.0) Low
<b>Fuel Consumption</b> gal/hr (L/hr)	<b>Fuel Consumption</b> gal/hr (L/hr)
0.07 (0.27) Boost	0.13 (0.51) Boost
0.06 (0.21) High	0.10 (0.38) High
0.04 (0.14) Medium	0.07 (0.25) Medium
0.02 (0.10) Low	0.03 (0.13) Low
<b>Electrical Consumption</b>	<b>Electrical Consumption</b>
2.8 amps Boost	3.3 amps Boost
1.9 amps High	2.0 amps High
1.0 amps Medium	1.1 amps Medium
0.67 amps Low	0.6 amps Low
<b>Air Throughput</b>	<b>Air Throughput</b>
48 cfm Boost	85 cfm Boost
40 cfm High	69 cfm High
27 cfm Medium	50 cfm Medium
19 cfm Low	30 cfm Low
<b>Weight</b>	<b>Weight</b>
6 lbs. (2.7 kg)	9.9 lbs. (4.5 kg)
<b>Dimensions</b>	<b>Dimensions</b>
L= 12.2" (31 cm)	L= 14.6" (37 cm)
W= 4.5" (11.5 cm)	W= 5.5" (14 cm)
H= 4.8" (12.2 cm)	H= 5.9" (15 cm)

Specifications provided by Espar Heating Systems

## Truck & Trailer Parts – REFRIGERATION



### Cap, Check Valve

Order Part #: P-14-50051-00  
(Replaces Carrier #: 14-50051-00)



### Cap, Flare

Order Part #: P-40-00086-04  
(Replaces Carrier #: 40-00086-04)

Looking for vehicle-  
powered clutch and  
compressor parts?

Check with your local  
Thermo King Dealer.



### Coil, Condenser (30S)

Order Part #: P-08-60059-01  
(Replaces Carrier #: 08-60059-01)

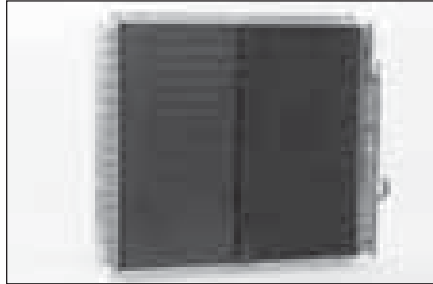

### Coil, Condenser

Order Part #: P-08-00206-11SV  
(Replaces Carrier #: 08-00206-11SV)



### Tubing Kit, Ultra Coil

Order Part #: P-79-02327-16  
(Replaces Carrier #: 79-02327-16)

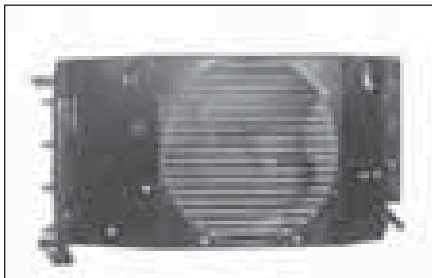

### Coil, Condenser/Radiator (6XX/7XX)

Order Part #: P-08-60086-04-SP  
(Replaces Carrier #: 08-60086-04-SP)

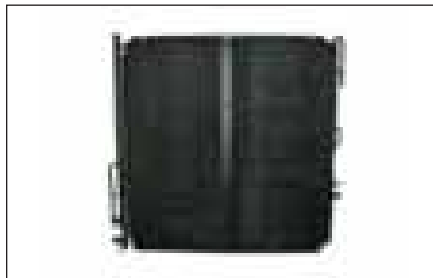

### Coil, Condenser/Radiator (Ultima)

Order Part #: P-08-01058-03SV  
(Replaces Carrier #: 08-01058-03SV)

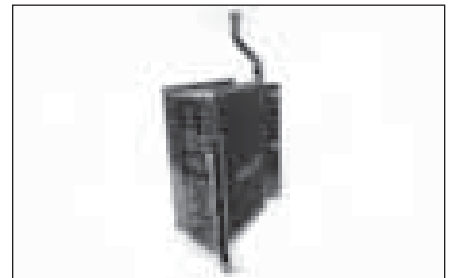

### Coil, Radiator

Order Part #: P-08-00181-03  
(Replaces Carrier #: 08-00181-03)



### Collar, Female, ORS, 1/4" (4)

Order Part #: P-40-60008-01  
(Replaces Carrier #: 40-60008-01)



### Collar, Female, ORS, 3/8" (6)

Order Part #: P-40-60008-02  
(Replaces Carrier #: 40-60008-02)



### Drier

Order Part #: P-14-00326-00  
(Replaces Carrier #: 14-00326-00)

## Truck & Trailer Parts – REFRIGERATION

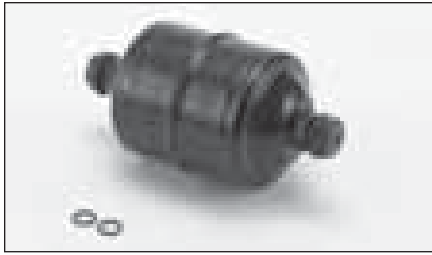

### Drier

Order Part #: P-14-00326-04  
(Replaces Carrier #: 14-00326-04)



### Drier, Filter

Order Part #: P-14-00326-05  
(Replaces Carrier #: 14-00326-05)

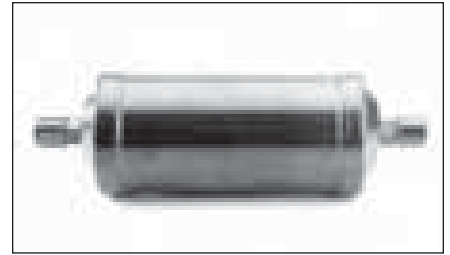

### Drier, Filter (High Acid Capacity)

Order Part #: P-14-00036-00  
(Replaces Carrier #: 14-00036-00)

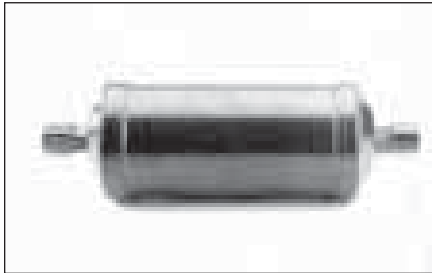

### Drier, Filter

Order Part #: 66-1723  
(Replaces Carrier #: 14-00036-02)



### Drier, Filter with O-Rings (High Moisture Capacity)

Order Part #: P-14-00209-00  
(Replaces Carrier #: 14-00209-00)

**Need an Additional  
O-Ring  
for this  
drier?**



### O-Ring, Drier

Order Part #: P-14-00209-20  
(Replaces Carrier #: 14-00209-20)

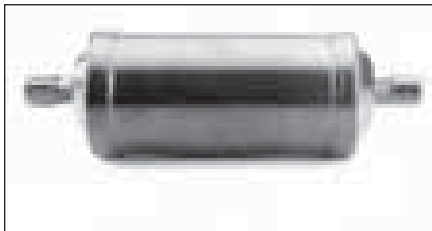

### Drier, Filter (R22)

Order Part #: P-14-50041-00  
(Replaces Carrier #: 14-50041-00)

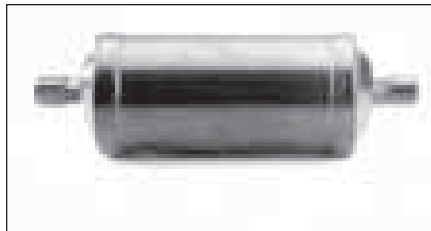

### Drier, Filter

Order Part #: P-14-01063-05  
(Replaces Carrier #: 14-01063-05)

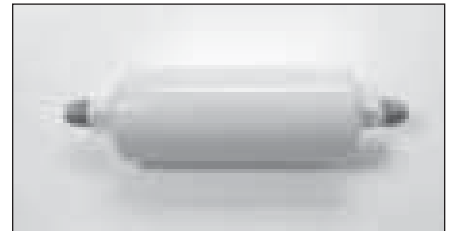

### Drier, Filter

Order Part #: P-14-60066-00  
(Replaces Carrier #: 14-60066-00)



### Flange, Compressor

Order Part #: P-40-50031-00  
(Replaces Carrier #: 40-50031-00)

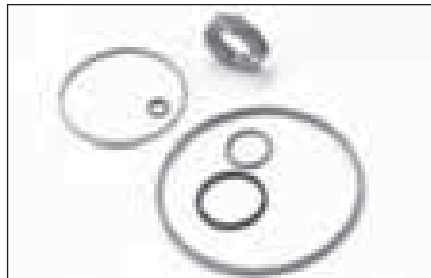

### Gasket Set, 3 Way Valve

Order Part #: P-14-50046-00  
(Replaces Carrier #: 14-50046-00)



### Indicator, Moisture

Order Part #: P-14-01092-03  
(Replaces Carrier #: 14-01092-03)

## Truck & Trailer Parts – REFRIGERATION



### Indicator, Moisture

Order Part #: P-14-01092-05  
(Replaces Carrier #: 14-01092-05)



### Sightglass

Order Part #: P-14-01092-12  
(Replaces Carrier #: 14-01092-12)



### Indicator, Sightglass

Order Part #: P-14-00220-00  
(Replaces Carrier #: 14-00220-00)

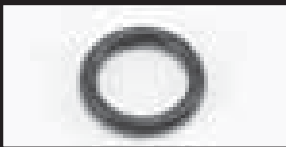

## O-RINGS SOLD INDIVIDUALLY



### O-Ring - 3/8"

Order Part #: P-42-60052-01  
(Replaces Carrier #: 42-60052-01)

### O-Ring .489 ID X .070 THK

Order Part #: P-42-00243-04  
(Replaces Carrier #: 42-00243-04)

### O-Ring .926 ID X .070

Order Part #: P-42-00243-16  
(Replaces Carrier #: 42-00243-16)

### O-Ring .301 ID X .070 THK

Order Part #: P-42-00243-10  
(Replaces Carrier #: 42-00243-10)

### O-Ring .551 ID X .070 THK

Order Part #: P-42-00243-13  
(Replaces Carrier #: 42-00243-13)

### O-Ring, Drier

Order Part #: P-14-00209-20  
(Replaces Carrier #: 14-00209-20)

### O-Ring .426 ID X .070 THK

Order Part #: P-42-00243-12  
(Replaces Carrier #: 42-00243-12)

### O-Ring .614 ID X .070 THK

Order Part #: P-42-00243-03  
(Replaces Carrier #: 42-00243-03)

### O-Ring, Service Valve

Order Part #: P-42-01159-00  
(Replaces Carrier #: 42-01159-00)

REFRIGERATION



### Sightglass (Prism Style)

Order Part #: P-14-50023-00  
(Replaces Carrier #: 14-50023-00)



### Plug, Fusible, Safety (1/4" MPT)

Order Part #: P-14-01032-00  
(Replaces Carrier #: 14-01032-00)



### Solenoid Valve Kit

Order Part #: P-16-00513-02  
(Replaces Carrier #: 16-00513-02)

## Truck & Trailer Parts – REFRIGERATION



**Kit, Repair (SV-1)**  
 (Specific to Carrier OEM solenoid valve. Do not use in P-14-01114-01 application.)  
 Order Part #: P-14-01114-50  
 (Replaces Carrier #: 14-01114-50)



**Solenoid Valve Kit (SV-3)**  
 (Specific to Carrier OEM solenoid valve. Do not use in P-14-01113-01 application.)  
 Order Part #: P-14-01113-50-C  
 (Replaces Carrier #: 14-01113-50)



**Solenoid Valve Kit (SV-2 & SV-4)**  
 Order Part #: P-14-00150-51  
 (Replaces Carrier #: 14-00150-50 and 14-00150-51)



**Valve, Solenoid w/o Coil (SV-2 & SV-4)**  
 Order Part #: P-14-00150-14  
 (Replaces Carrier #: 14-00150-14)

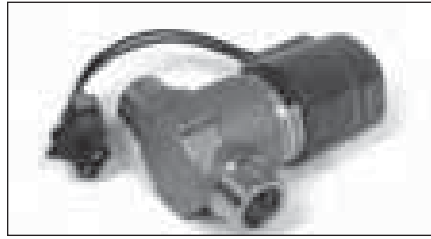

**Valve, Solenoid w/coil (SV-1)**  
 Order Part #: P-14-01114-01  
 (Replaces Carrier #: 14-01114-01)



**Valve, Solenoid (SV-3)**  
 Order Part #: P-14-01113-01  
 (Replaces Carrier #: 14-01113-01)

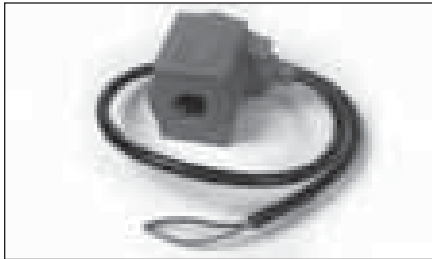

**Coil, Solenoid 12V**  
 Order Part #: P-22-60268-00  
 (Replaces Carrier #: 22-60268-00)

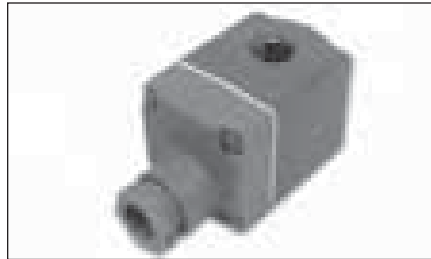

**Coil, Solenoid 12V**  
 Order Part #: P-22-60307-00  
 (Replaces Carrier #: 22-60307-00)

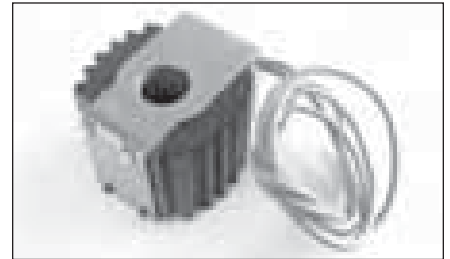

**Coil, Solenoid (24VDC)**  
 Order Part #: P-14-01091-02  
 (Replaces Carrier #: 14-01091-02)

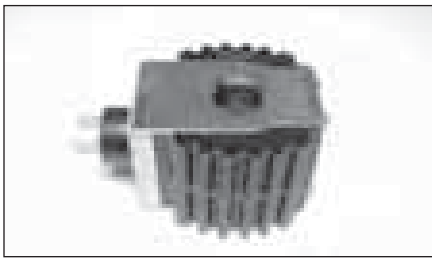

**Coil, Solenoid (SV-1)**  
 Order Part #: P-14-00147-05  
 (Replaces Carrier #: 14-00147-05)



**Coil, Solenoid (SV-1)**  
 Order Part #: P-14-01114-20  
 (Replaces Carrier #: 14-01114-20)

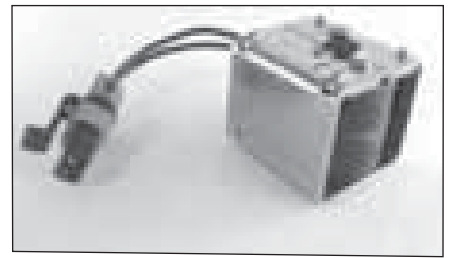

**Coil, Solenoid (SV-2 & 4)**  
 Order Part #: P-22-02579-00  
 (Replaces Carrier #: 22-02579-00)

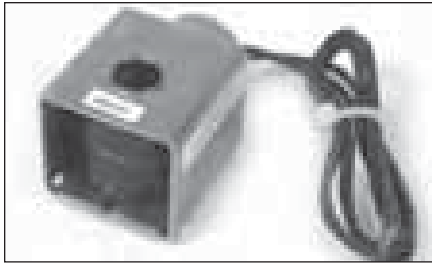

**Coil, Solenoid (SV-2/SV-4)**  
 Order Part #: P-22-02567-00  
 (Replaces Carrier #: 22-02567-00)

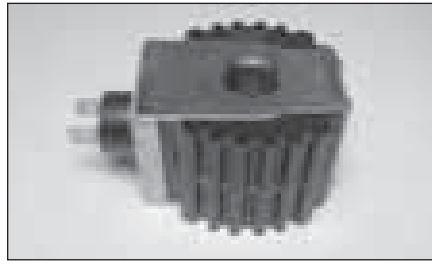

**Coil, Solenoid (SV-3)**  
 Order Part #: P-14-00145-03  
 (Replaces Carrier #: 14-00145-03)

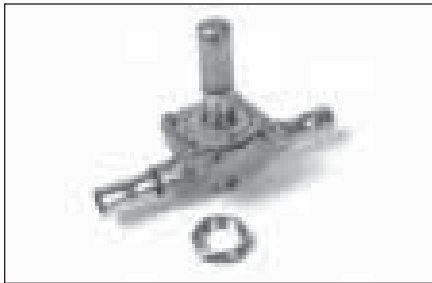

**Valve**  
 Order Part #: P-14-60063-00  
 (Replaces Carrier #: 14-60063-00)



**Valve, TXV R12**  
 Order Part #: P-14-00177-00  
 (Replaces Carrier #: 14-00177-00)



**Valve (TXV)  
 Less Flange R22**  
 Order Part #: P-14-01104-04  
 (Replaces Carrier #: 14-01104-04)



**Valve (TXV)  
 Less Flange R22**  
 Order Part #: P-14-01104-23  
 (Replaces Carrier #: 14-01104-23)



**Valve (TXV) Less Flange**  
 Order Part #: P-14-00177-03  
 (Replaces Carrier #: 14-00177-03)



**Valve (TXV)  
 Less Flange R500**  
 Order Part #: P-14-00177-01  
 (Replaces Carrier #: 14-00177-01)



**Valve (TXV)  
 Less Flange R502**  
 Order Part #: P-14-01095-04  
 (Replaces Carrier #: 14-01095-04)



**Valve (TXV), Quench R22**  
 Order Part #: P-14-00190-06  
 (Replaces Carrier #: 14-00190-06)



**Valve (TXV), Quench R22**  
 Order Part #: P-14-00190-00  
 (Replaces Carrier #: 14-00190-00)

## Truck & Trailer Parts – REFRIGERATION



### Valve (TXV), Quench R22

Order Part #: P-14-00190-03  
(Replaces Carrier #: 14-00190-03)



### Orifice, TXV

Order Part #: P-14-60009-04  
(Replaces Carrier #: 14-60009-04)



### Valve, Expansion R22

Order Part #: P-14-60022-00  
(Replaces Carrier #: 14-60022-00)

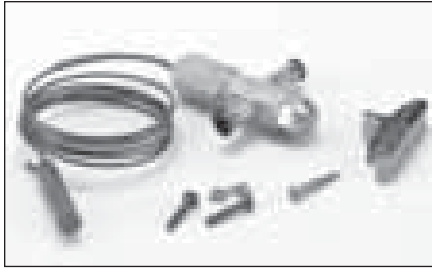

### Valve (TXV), Quench R22

Order Part #: P-14-00190-05  
(Replaces Carrier #: 14-00190-05)

**Orifice, TXV (NO. 2)**  
Order Part #: 61-1261  
(Replaces Carrier #: 14-60009-02)

### Orifice, TXV (NO. 3)

Order Part #: P-14-60009-03  
(Replaces Carrier #: 14-60009-03)

### Orifice, TXV (NO. 5)

Order Part #: P-14-60009-05  
(Replaces Carrier #: 14-60009-05)

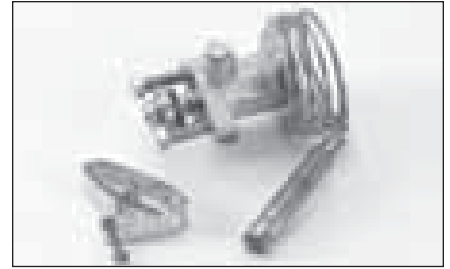

### Valve, Expansion R404A

Order Part #: P-14-01104-36  
(Replaces Carrier #: 14-01104-36)



### Valve, Expansion R404A

Order Part #: P-14-60039-00  
(Replaces Carrier #: 14-60039-00)

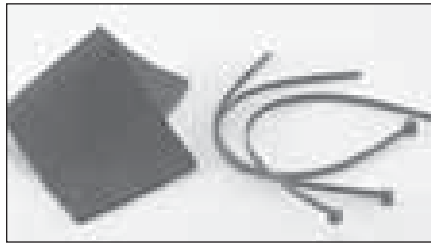

### Insulator Kit, (Quench Valve)

Order Part #: P-76-50056-00  
(Replaces Carrier #: 76-50056-00)



### Strainer

Order Part #: P-14-00176-00  
(Replaces Carrier #: 14-00176-00)



### Seat, Check Valve

Order Part #: P-16-00171-00  
(Replaces Carrier #: 16-00171-00)

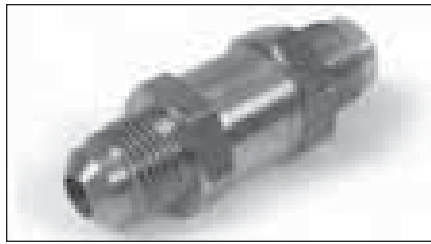

### Valve Check

Order Part #: P-14-00181-02  
(Replaces Carrier #: 14-00181-02)

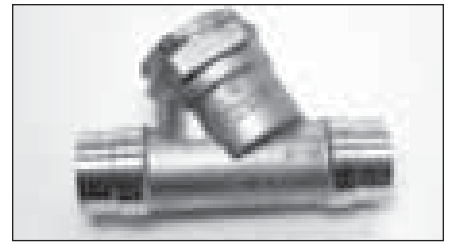

### Valve, Check

Order Part #: P-14-00029-07  
(Replaces Carrier #: 14-00029-07)

## Truck & Trailer Parts – REFRIGERATION

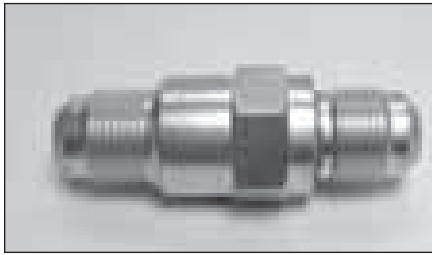

### Valve, Check

Order Part #: P-14-00181-03  
(Replaces Carrier #: 14-00181-03)

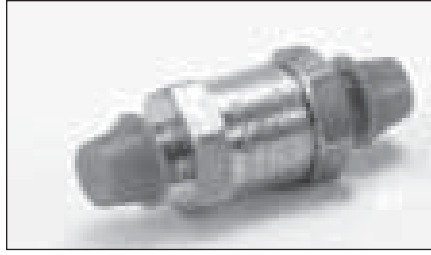

### Valve, Check 1/4 (R22)

Order Part #: P-14-00181-00  
(Replaces Carrier #: 14-00181-00)



### Valve, Check 1/4 ORS

Order Part #: P-14-60026-00  
(Replaces Carrier #: 14-60026-00)



### Valve, Check 3/8"

Order Part #: P-14-00286-00  
(Replaces Carrier #: 14-00286-00)



### Valve, Check 3/8 ORS

Order Part #: P-14-60026-01  
(Replaces Carrier #: 14-60026-01)

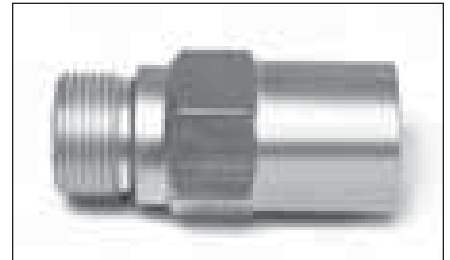

### Valve, Check 5/8"

Order Part #: P-14-00286-03  
(Replaces Carrier #: 14-00286-03)



### Valve, Check Repair Kit

Order Part #: P-14-50050-01  
(Replaces Carrier #: 14-50050-01)



### Valve, Check

Order Part #: P-14-00199-00  
(Replaces Carrier #: 14-00199-00)



### Valve, Check

Order Part #: P-14-00281-02  
(Replaces Carrier #: 14-00281-02)

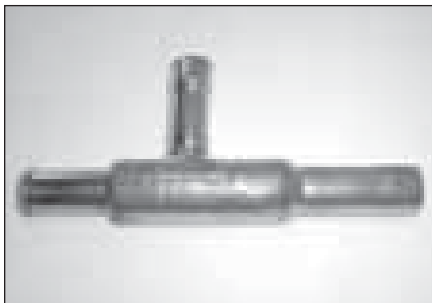

### Valve, Crankcase

Order Part #: P-14-00205-00  
(Replaces Carrier #: 14-00205-00)



### Valve, Hot Gas

Order Part #: P-14-00276-01  
(Replaces Carrier #: 14-00276-01)



### Valve, Pres. Reg.

Order Part #: P-14-60000-01  
(Replaces Carrier #: 14-60000-01)

## Truck & Trailer Parts – REFRIGERATION



### Valve, Pres. Reg

Order Part #: P-14-60000-00  
(Replaces Carrier #: 14-60000-00)

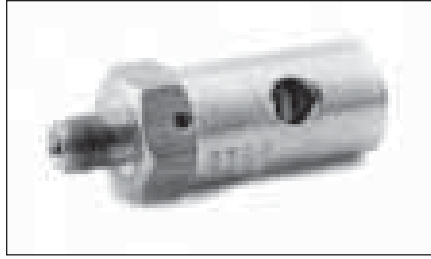

### Valve, Pressure Relief

Order Part #: P-14-01109-00  
(Replaces Carrier #: 14-01109-00)



### Valve, Service 1-1/8"

Order Part #: P-14-01042-06  
(Replaces Carrier #: 14-01042-06)



### Valve, Service

Order Part #: P-14-60023-01  
(Replaces Carrier #: 14-60023-01)



### Valve, Service 7/8"

Order Part #: P-14-01042-04  
(Replaces Carrier #: 14-01042-04)



### Valve, Solenoid w/o Coil

Order Part #: P-14-00269-01  
(Replaces Carrier #: 14-00269-01)



### Valve, Solenoid

Order Part #: P-14-60051-00  
(Replaces Carrier #: 14-60051-00)

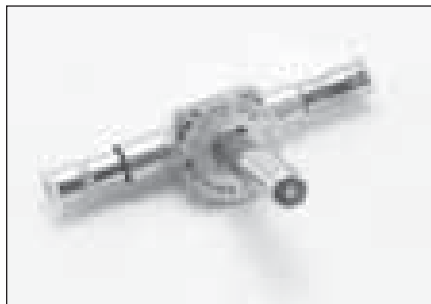

### Valve, Solenoid

Order Part #: P-14-60062-00  
(Replaces Carrier #: 14-60062-00)

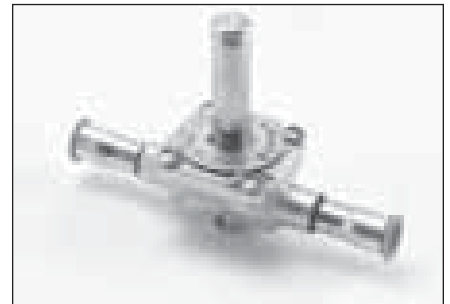

### Valve, w/ Inlet Bell

Order Part #: P-14-60024-00  
(Replaces Carrier #: 14-60024-00)



### Vibrasorber, Discharge '99

Order Part #: P-73-60010-03  
(Replaces Carrier #: 73-60010-03)



### Vibrasorber, Discharge

Order Part #:  
(Replaces Carrier #: 73-00326-00)

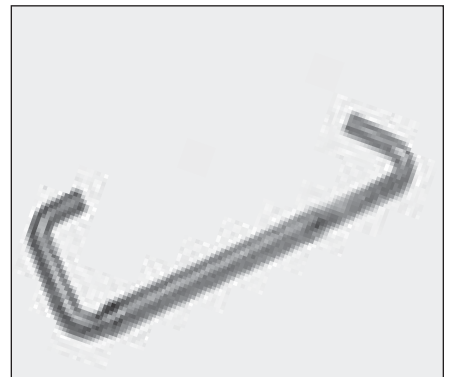

### Vibrasorber, Discharge

Order Part #: P-73-00326-01  
(Replaces Carrier #: 73-00326-01)

REFRIGERATION

## Truck & Trailer Parts – REFRIGERATION

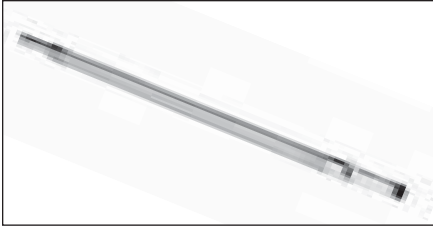

### Vibrasorber, Discharge

Order Part #: P-73-00328-05  
(Replaces Carrier #: 73-00328-05)

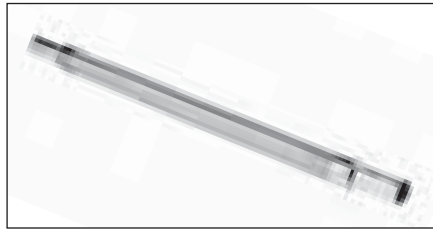

### Vibrasorber, Discharge

Order Part #: P-73-00328-00  
(Replaces Carrier #: 73-00328-00)

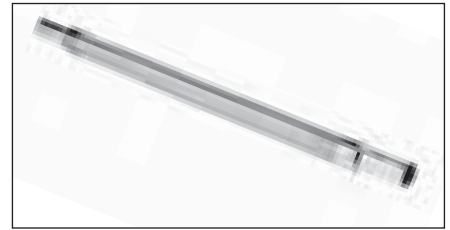

### Vibrasorber, Discharge

Order Part #: P-73-00328-01  
(Replaces Carrier #: 73-00328-01)

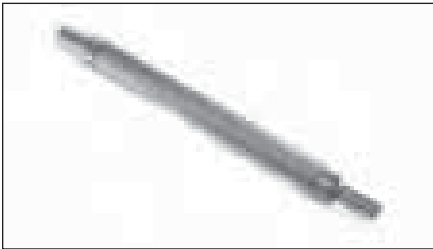

### Vibrasorber, Discharge

Order Part #: P-73-60010-00  
(Replaces Carrier #: 73-60010-00)



### Vibrasorber, Discharge

Order Part #: P-73-60010-02  
(Replaces Carrier #: 73-60010-02)



### Vibrasorber, Suc/Dis

Order Part #: P-73-00328-03  
(Replaces Carrier #: 73-00328-03)



### Vibrasorber, Suction

Order Part #: P-151792  
(Replaces Carrier #: 151792)

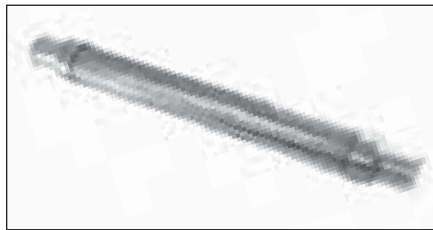

### Vibrasorber, Suction

Order Part #: P-7102273  
(Replaces Carrier #: 7102273)

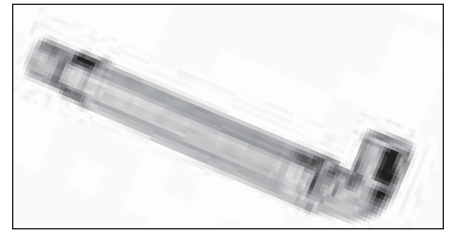

### Vibrasorber, Suction

Order Part #: P-73-00325-00  
(Replaces Carrier #: 73-00325-00)

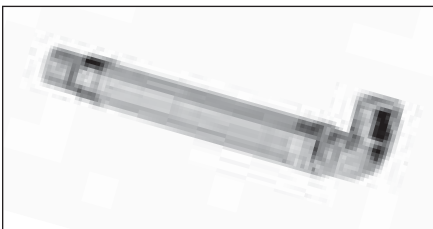

### Vibrasorber, Suction

Order Part #: P-73-00325-01  
(Replaces Carrier #: 73-00325-01)

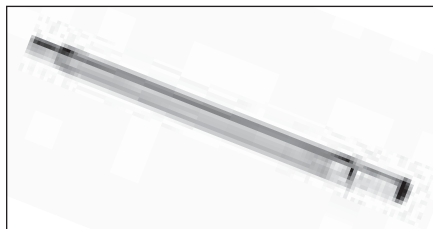

### Vibrasorber, Suction

Order Part #: P-73-00328-02  
(Replaces Carrier #: 73-00328-02)



### Vibrasorber, Suction

Order Part #: P-73-60024-00  
(Replaces Carrier #: 73-60024-00)

## Truck & Trailer Parts – ELECTRICAL

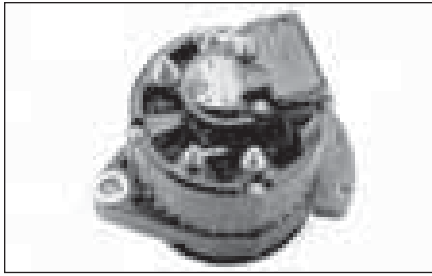

### Alternator (65A)

Order Part #: P-30-00423-00  
(Replaces Carrier #: 30-00423-00)

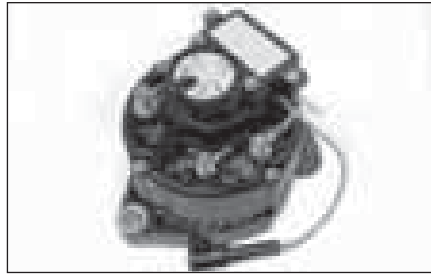

### Alternator, 105 Amp (less pulley)

Order Part #: P-30-00409-11  
(Replaces Carrier #: 30-00409-11)



### Alternator, 37 Amp

Order Part #: P-30-50324-00  
(Replaces Carrier #: 30-50324-00)

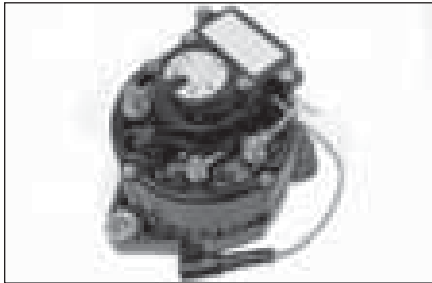

### Alternator, 65 Amp (less pulley)

Order Part #: P-30-00409-10  
(Replaces Carrier #: 30-00409-10)

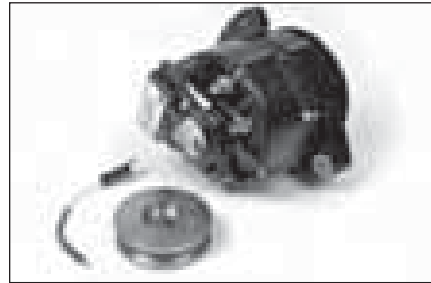

### Alternator, 65 Amp (w/ pulley)

Order Part #: P-30-50326-00  
(Replaces Carrier #: 30-50326-00)



### Alternator, 70 Amp

Order Part #: P-30-60050-04  
(Replaces Carrier #: 30-60050-04)

### Alternator, 65 Amp (less pulley) REMAN.

Order Part #: P-30-00409-10RM  
(Replaces Carrier #: 30-00409-10RM)

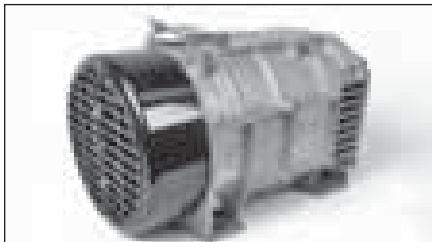

### Generator

Order Part #: P-54-00136-05  
(Replaces Carrier #: 54-00136-05)

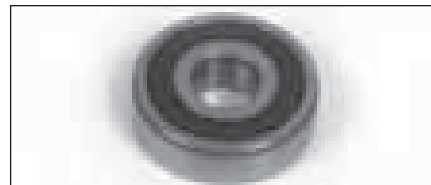

### Bearing, Alt. Rear

Order Part #: P-04-60008-04  
(Replaces Carrier #: 04-60008-04)

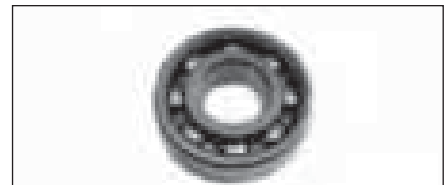

### Bearing, Alternator

Order Part #: P-04-60008-24  
(Replaces Carrier #: 04-60008-24)



### Bearing, Motor, Front

Order Part #: P-160165  
(Replaces Carrier #: 160165)



### Board, Diode

Order Part #: P-22-01102-10  
(Replaces Carrier #: 22-01102-10)

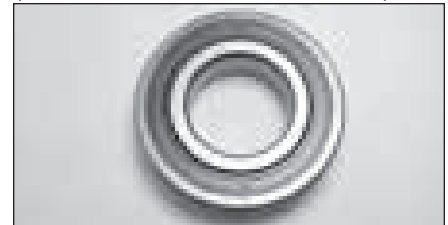

### Bearing, Motor

Order Part #: P-04-60008-32  
(Replaces Carrier #: 04-60008-32)

### Bearing, Motor

Order Part #: P-04-60008-34  
(Replaces Carrier #: 04-60008-34)

## Truck & Trailer Parts – ELECTRICAL

**Boots for Speed and Starter Solenoids are in the Engine Section with the Solenoids.**

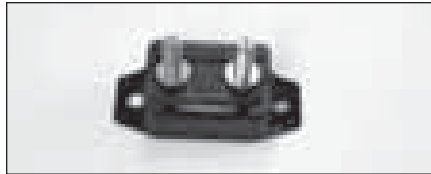

### Breaker, Circuit (20A)

Order Part #: P-10-00171-03  
(Replaces Carrier #: 10-00171-03)

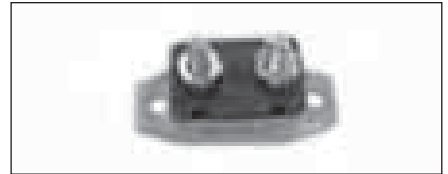

### Breaker, Circuit (CB-2, 25A)

Order Part #: P-10-00171-09  
(Replaces Carrier #: 10-00171-09)

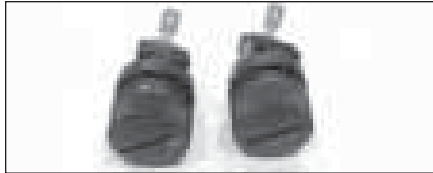

### Brush & Cap

Order Part #: P-54-60006-30SV  
(Replaces Carrier #: 54-60006-30SV)

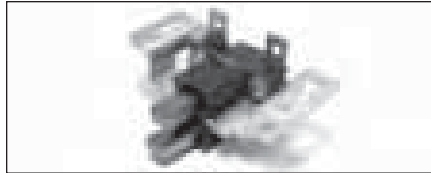

### Brush Assem., Alternator

Order Part #: P-30-00409-30  
(Replaces Carrier #: 30-00409-30)



### Brush Assy

Order Part #: P-30-00363-25  
(Replaces Carrier #: 30-00363-25)



### Brush Assy., (rear evap fan motor)

Order Part #: P-16-02527-00  
(Replaces Carrier #: 16-02527-00)

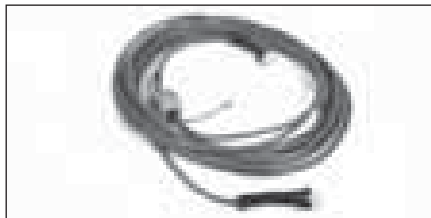

### Cable, Cab Command

Order Part #: P-22-60013-00  
(Replaces Carrier #: 22-60013-00)

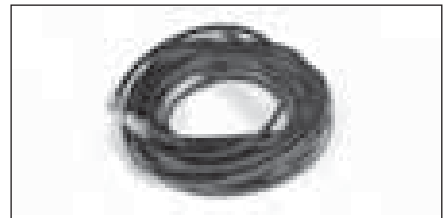

### Cable, Cab Command

Order Part #: P-22-60551-00  
(Replaces Carrier #: 22-60551-00)

**ELECTRICAL**

**CHECK OUT PAGE 60 FOR OUR PG MOTOR, EVAPORATOR FAN & PARTS.**

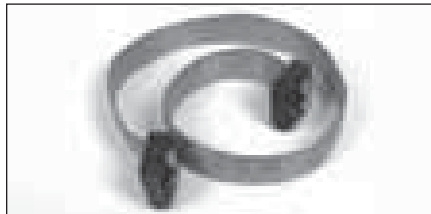

### Cable, Ribbon

Order Part #: P-22-01641-00  
(Replaces Carrier #: 22-01641-00)



### Cap, Switch

Order Part #: P-58-60158-00  
(Replaces Carrier #: 58-60158-00)



### Cap, Switch

Order Part #: P-58-60158-01  
(Replaces Carrier #: 58-60158-01)

## Truck & Trailer Parts – ELECTRICAL

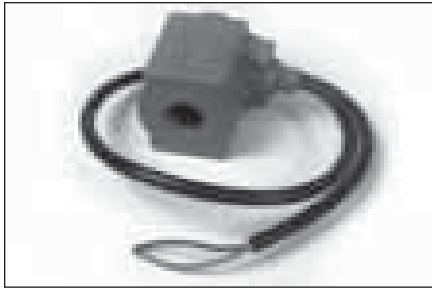

### Coil, Solenoid 12V

Order Part #: P-22-60268-00  
(Replaces Carrier #: 22-60268-00)

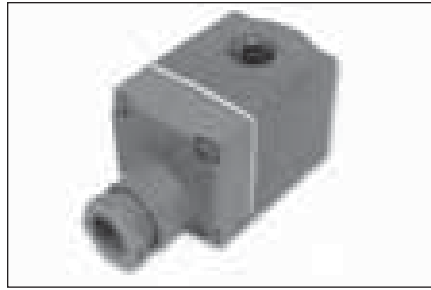

### Coil, Solenoid 12V

Order Part #: P-22-60307-00  
(Replaces Carrier #: 22-60307-00)

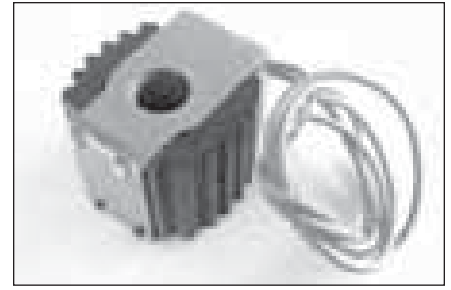

### Coil, Solenoid (24VDC)

Order Part #: P-14-01091-02  
(Replaces Carrier #: 14-01091-02)

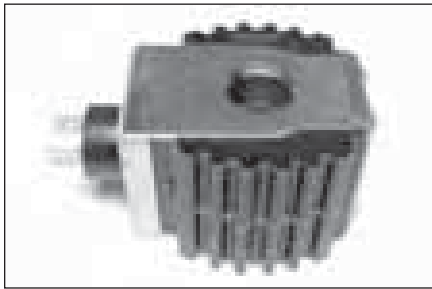

### Coil, Solenoid (SV-1)

Order Part #: P-14-00147-05  
(Replaces Carrier #: 14-00147-05)



### Coil, Solenoid (SV-1)

Order Part #: P-14-01114-20  
(Replaces Carrier #: 14-01114-20)

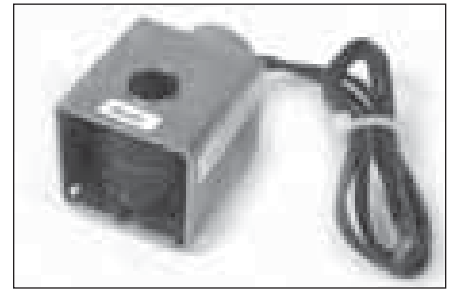

### Coil, Solenoid (SV-2/SV-4)

Order Part #: P-22-02567-00  
(Replaces Carrier #: 22-02567-00)

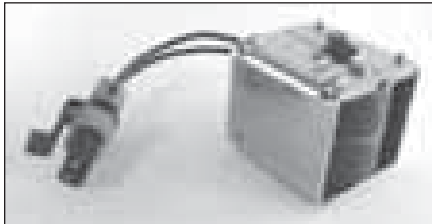

### Coil, Solenoid (SV-2/SV-4)

Order Part #: P-22-02579-00  
(Replaces Carrier #: 22-02579-00)

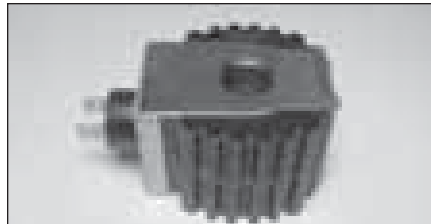

### Coil, Solenoid (SV-3)

Order Part #: P-14-00145-03  
(Replaces Carrier #: 14-00145-03)

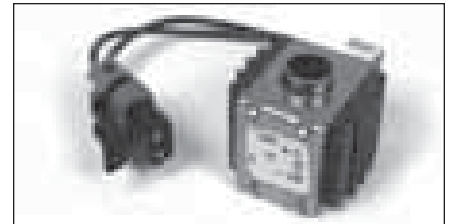

### Coil, Solenoid (3-Way Valve)

Order Part #: P-14-01110-01  
(Replaces Carrier #: 14-01110-01)



### Capacitor

Order Part #: P-10-60040-05  
(Replaces Carrier #: 10-60040-05)



### Capacitor

Order Part #: P-10-60047-03  
(Replaces Carrier #: 10-60047-03)



### Capacitor (40 MF)

Order Part #: P-10-60047-00  
(Replaces Carrier #: 10-60047-00)

## Truck & Trailer Parts – ELECTRICAL



**Capacitor  
350 MFD @ 165/205V**  
Order Part #: P-10-60048-06  
(Replaces Carrier #: 10-60048-06)



**Capacitor 60MFD @ 450V**  
Order Part #: P-10-60047-05  
(Replaces Carrier #: 10-60047-05)



**Capacitor, 63V 22000 MFD**  
Order Part #: P-10-60040-01  
(Replaces Carrier #: 10-60040-01)



**Capacitor, Start (150MF)**  
Order Part #: P-10-60048-03  
(Replaces Carrier #: 10-60048-03)



**Capacitor, Start (200MF)**  
Order Part #: P-10-60048-05  
(Replaces Carrier #: 10-60048-05)



***Now Available!***

**Capacitor**  
Order Part #: P-54-00136-24  
(Replaces Carrier #: 54-00136-24)



***Now Available!***

**Capacitor 4 MFD@400V**  
ORDER PART #: P-10-60038-00  
(Replaces Carrier #: 10-60038-00)



***Now Available!***

**Capacitor 50 MFD@230V**  
ORDER PART #: P-10-60038-12  
(Replaces Carrier #: 10-60038-12)



**Contactor**  
Order Part #: P-10-00433-00  
(Replaces Carrier #: 10-00433-00)

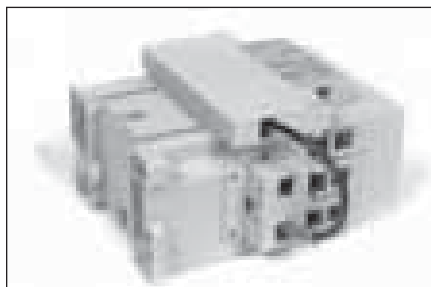

**Contactor**  
Order Part #: P-10-00433-05  
(Replaces Carrier #: 10-00433-05)

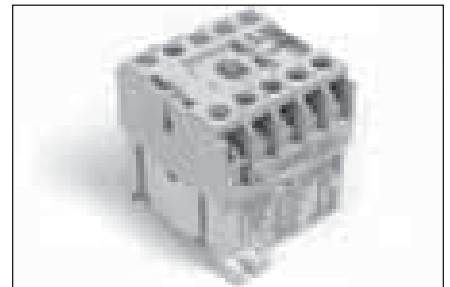

**Contactor**  
Order Part #: P-12-60044-05  
(Replaces Carrier #: 12-60044-05)

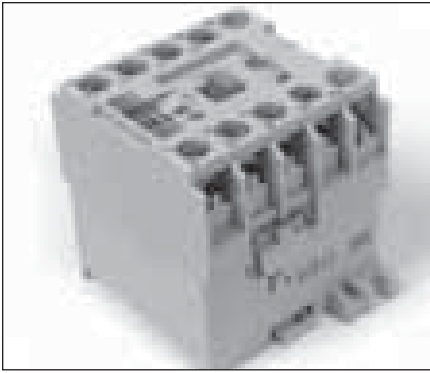

**Contactor**

Order Part #: P-12-60044-01  
(Replaces Carrier #: 12-60044-01)

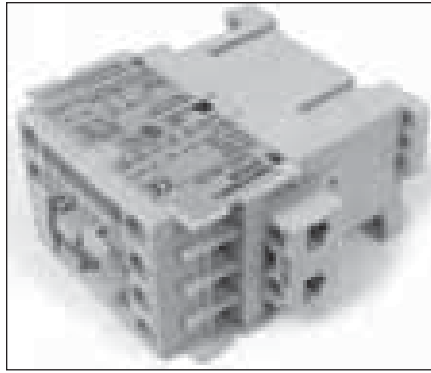

**Contactor, 3 Pole**

Order Part #: P-10-00391-20  
(Replaces Carrier #: 10-00391-20)

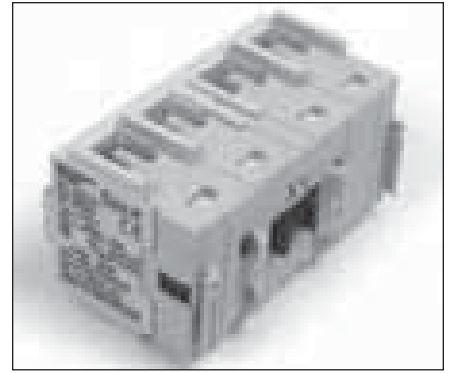

**Contactor**

Order Part #: P-10-60043-00  
(Replaces Carrier #: 10-60043-00)

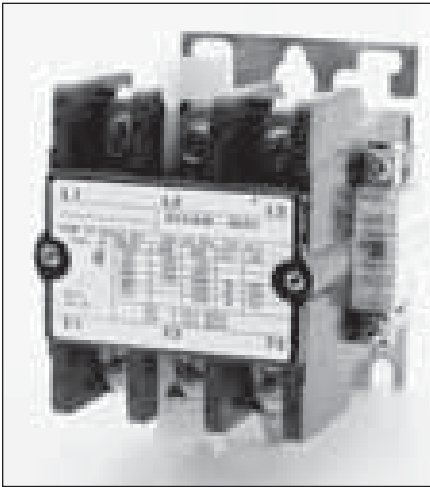

**Contactor, 4 Pole (40A)**

Order Part #: P-10-00279-00  
(Replaces Carrier #: 10-00279-00)



**Control, Fan Cycling**

Order Part #: P-101-1025  
(Replaces Carrier #: 101-1025)

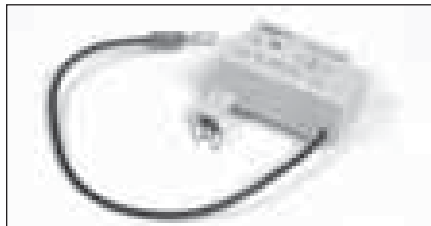

**Diode**

Order Part #: P-12-60049-00  
(Replaces Carrier #: 12-60049-00)

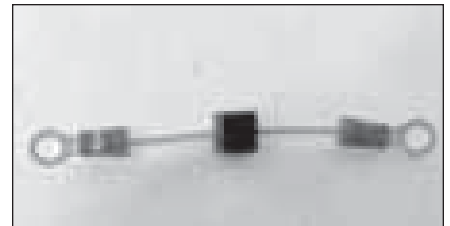

**Diode (6A)**

Order Part #: P-22-01030-17  
(Replaces Carrier #: 22-01030-17)

**ALSO  
AVAILABLE**

**Diode, Bridge**

Order Part #: P-30-60050-21  
(Replaces Carrier #: 30-60050-21)

# Truck & Trailer Parts – ELECTRICAL

**Harness, Transducer**  
 Order Part #: P-22-04036-00SV  
 (Replaces Carrier #: 22-04036-00SV)

**ALSO AVAILABLE**

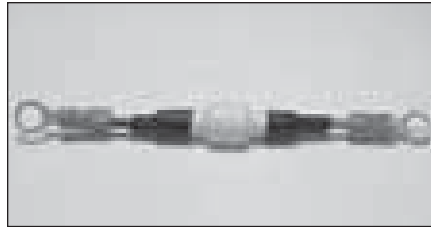

**Diode, Solenoid**  
 Order Part #: P-136854  
 (Replaces Carrier #: 136854)

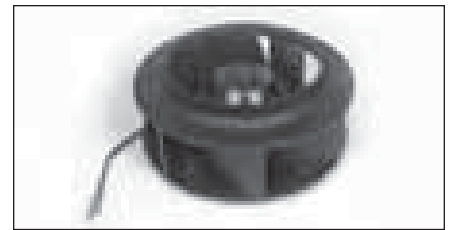

**Fan, Motor Thin Line Evap**  
 Order Part #: P-54-60022-08  
 (Replaces Carrier #: 54-60022-08)

**ELECTRICAL**

<div style="border: 1px solid black; padding: 5px; display: inline-block;"><b>MASTER FUSE CHART</b></div>																				
		Description	Advantage	Eagle	Extra	Optima	TBird	Ulma	Ultra	EuroPhoenix	Maxima	Supra 922/944	Supra 722/744	Supra 622/644	Supra 422	Supra 322	Integra 30S	Integra 40S	Integra 50S	Solara
P-12-00526-88 Replaces Carrier #12-00526-88	Fuse 1A Time Delay																	X	X	
P-22-60102-05 Replaces Carrier #22-60102-05	Fuse 3.15A (For 3 PH)																	X	X	
P-22-60340-01 Replaces Carrier #22-60340-01	Fuse 50 AMP																	X	X	
P-22-60102-07 Replaces Carrier #22-60102-07	Fuse 6.3A																	X	X	
P-22-60543-06 Replaces Carrier #22-60543-06	Fuse, 10A																	X	X	
P-22-02336-16 Replaces Carrier #22-02336-16	Fuse, 40 Amp															X				
P-22-60340-04 Replaces Carrier #22-60340-04	Fuse, 80 Amp													X	X					
P-22-02336-03 Replaces Carrier #22-02336-03	Fuse, Blade (3A)	X				X			X	X										
P-22-02336-04 Replaces Carrier #22-02336-04	Fuse, Blade (10A)	X		X	X	X	X	X	X			X		X						
P-22-02336-06 Replaces Carrier #22-02336-06	Fuse, Blade (15A)	X		X	X		X	X		X	X	X	X	X						
P-22-02336-01 Replaces Carrier #22-02336-01	Fuse, Blade (20A)	X	X	X	X	X	X	X		X	X	X	X	X						
P-22-02336-05 Replaces Carrier #22-02336-05	Fuse, Blade (25A)	X		X	X	X	X	X	X	X	X	X	X	X						
P-22-02336-00 Replaces Carrier #22-02336-00	Fuse, Blade (30A)	X	X			X			X	X										
P-22-02336-02 Replaces Carrier #22-02336-02	Fuse, Blade (5A)	X	X	X	X	X	X	X	X	X	X	X	X	X						
P-22-02336-08 Replaces Carrier #22-02336-08	Fuse, Blade (7.5A)	X		X	X		X	X		X										
P-22-02336-09 Replaces Carrier #22-02336-09	Fuse, Blade (80A)	X		X	X		X	X		X	X	X	X	X						X
P-22-00060-03 Replaces Carrier #22-00060-03	Fuse, Glass (15A)		X	X				X												
P-22-00060-16 Replaces Carrier #22-00060-16	Fuse, Glass (2A)		X																	
P-22-00060-20 Replaces Carrier #22-00060-20	Fuse, Glass, 1" (3A)					X														

## Truck & Trailer Parts – ELECTRICAL

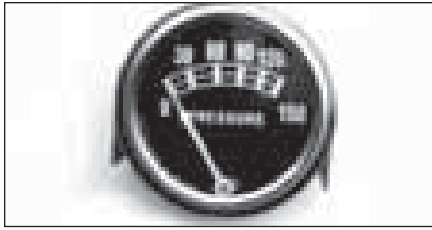

### Gauge, Oil Pressure

Order Part #: P-12-00011-00  
(Replaces Carrier #: 12-00011-00)

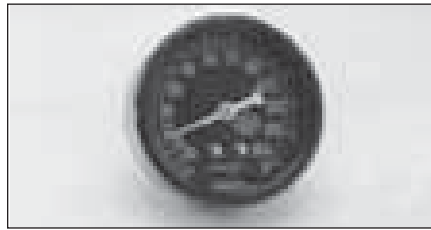

### Gauge, Suction Pressure

Order Part #: P-12-00003-00  
(Replaces Carrier #: 12-00003-00)

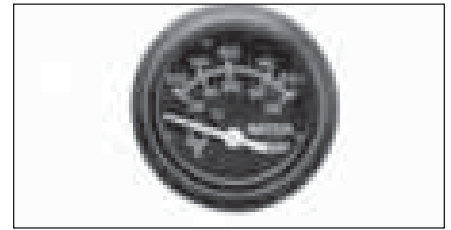

### Gauge, Water Temp

Order Part #: P-12-00097-03  
(Replaces Carrier #: 12-00097-03)

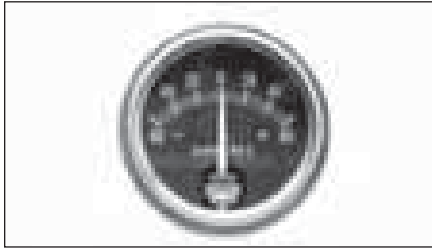

### Gauge, Ammeter (+60A/-60A)

Order Part #: P-22-00538-01SV  
(Replaces Carrier #: 22-00538-01SV)



### Gauge, Fuel (w/Float & Arm)

Order Part #: P-12-00104-99  
(Replaces Carrier #: 12-00104-99)

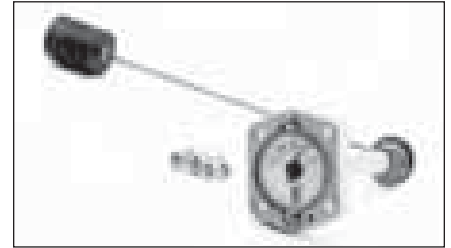

### Gauge, Fuel (w/Float & Arm)

Order Part #: P-12-01141-00  
(Replaces Carrier #: 12-01141-00)

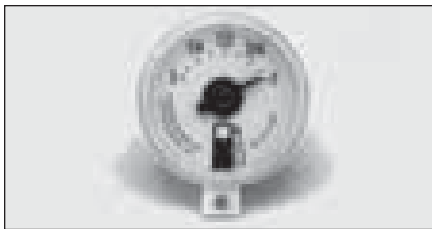

### Dial, Fuel Gauge

Order Part #: P-12-01141-20  
(Replaces Carrier #: 12-01141-20)



### Harness, Alternator

Order Part #: P-22-60365-01SV  
(Replaces Carrier #: 22-60365-01SV)



### Harness, Cab Command

Order Part #: P-22-02624-00  
(Replaces Carrier #: 22-02624-00)



### Dial, Fuel Gauge

Order Part #: P-12-00104-03  
(Replaces Carrier #: 12-00104-03)

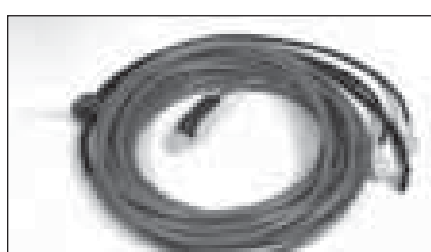

### Harness, Cab Command

Order Part #: P-22-60342-00  
(Replaces Carrier #: 22-60342-00)



### Harness, Cab Command

Order Part #: P-22-60168-00  
(Replaces Carrier #: 22-60168-00)

## Truck & Trailer Parts – ELECTRICAL

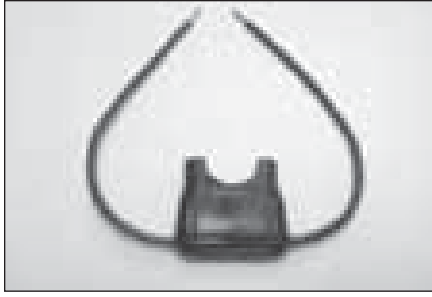

### Holder, Fuse

Order Part #: P-22-60313-00  
(Replaces Carrier #: 22-60313-00)



### Keypad, Micro Display (Reman) For Standard or Summit micros on Ultra, Ultima and Extra

Order Part #: P-12-00307-00SVRM  
(Replaces Carrier #: 12-00307-00SVRM)

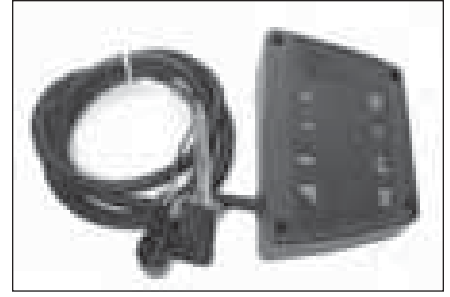

### Light Bar Assembly

Order Part #: P-76-00542-00  
(Replaces Carrier #: 76-00542-00)



### Motor (PG), Evaporator Fan

Order Part #: P-54-60006-13  
(Replaces Carrier #: 54-60006-13)

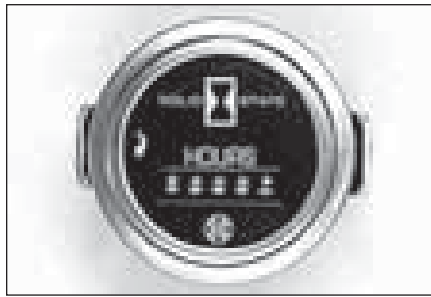

### Meter, Hour

Order Part #: P-10-01165-00  
(Replaces Carrier #: 10-01165-00)

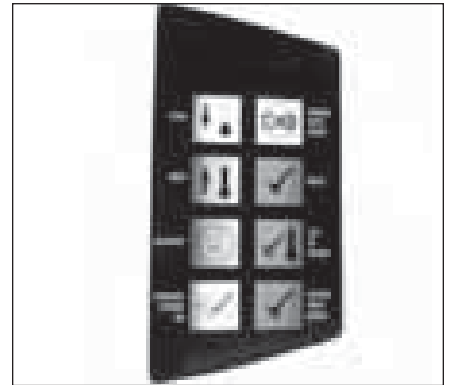

### Decal, Light Bar

Order Part #: P-22-01465-53  
(Replaces Carrier #: 22-01465-53)

**NOTE: Brush & Cap shown  
below are only for PG  
Motor above.**



### Brush Set for PG Motor

Order Part #: P-54-60006-30PG  
Not available from Carrier



### Cap, Brush for PG Motor

Order Part #: P-54-60006-31PG  
Not available from Carrier



### Meter, Volt

Order Part #: P-133234  
(Replaces Carrier #: 133234)

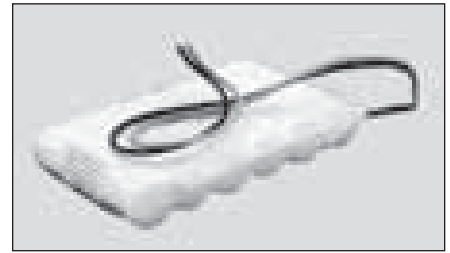

### Pack, Battery

Order Part #: P-30-00407-02SV  
(Replaces Carrier #: 30-00407-02SV)



### Plug, Power

Order Part #: P-22-01131-03  
(Replaces Carrier #: 22-01131-03)

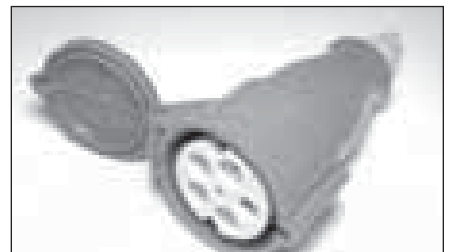

### Plug, Power

Order Part #: P-22-01513-00  
(Replaces Carrier #: 22-01513-00)



**Probe, Thermistor  
(Eng Temp)**

Order Part #: P-12-00312-03  
(Replaces Carrier #: 12-00312-03)

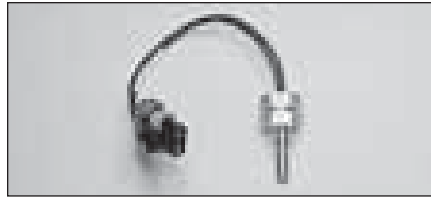

**Probe, Thermistor**

Order Part #: P-12-01145-03  
(Replaces Carrier #: 12-01145-03)

**LOOKING FOR GLOW  
PLUGS?  
THEY CAN BE FOUND IN  
THE ENGINE SECTION.**

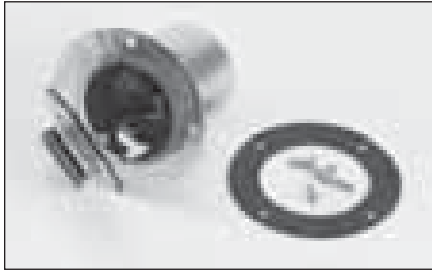

**Receptacle, 250V/3PH/50A**

Order Part #: P-22-01132-03  
(Replaces Carrier #: 22-01132-03)

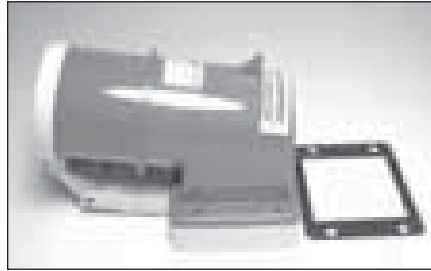

**Receptacle, Power**

Order Part #: P-22-01512-00  
(Replaces Carrier #: 22-01512-00)

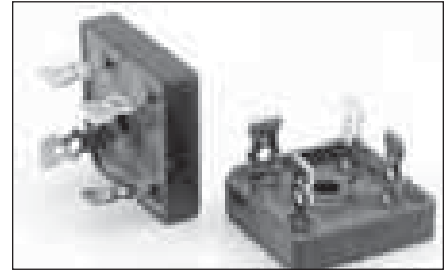

**Rectifier, Charging System**

Order Part #: P-10-01120-00  
(Replaces Carrier #: 10-01120-00)

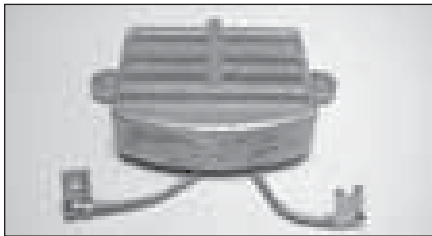

**Regulator**

Order Part #: P-133281  
(Replaces Carrier #: 133281)

**Regulator**  
Order Part #: P-30-60050-20  
(Replaces Carrier #: 30-60050-20)

**ALSO AVAILABLE**

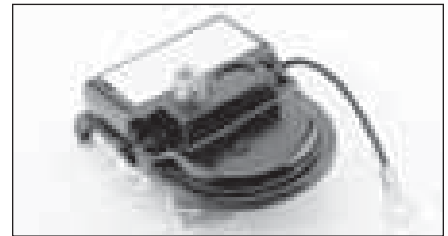

**Regulator, Voltage**

Order Part #: P-30-00423-02  
(Replaces Carrier #: 30-00423-02)

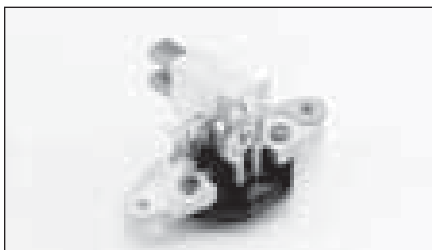

**Regulator, Voltage**

Order Part #: P-30-00393-30  
(Replaces Carrier #: 30-00393-30)



**Regulator, Voltage**

Order Part #: P-30-00409-44  
(Replaces Carrier #: 30-00409-44)

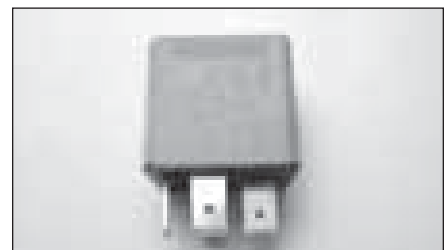

**Relay**

Order Part #: P-10-00286-07  
(Replaces Carrier #: 10-00286-07)

**ELECTRICAL**

## Truck & Trailer Parts – ELECTRICAL



### Relay

Order Part #: P-10-00385-00  
(Replaces Carrier #: 10-00385-00)

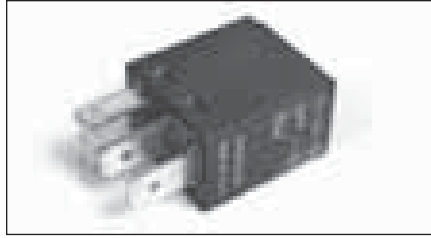

### Relay

Order Part #: P-10-00385-02  
(Replaces Carrier #: 10-00385-02)

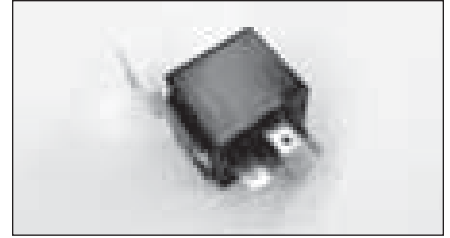

### Relay (SP, DT, NC, w/Diode)

Order Part #: P-10-00286-02  
(Replaces Carrier #: 10-00286-02)

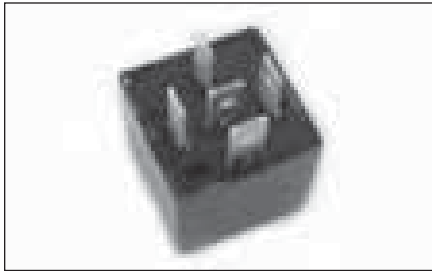

### Relay, (40A, 12V)

Order Part #: P-10-00286-04  
(Replaces Carrier #: 10-00286-04)



### Relay, (70A)

Order Part #: P-10-00328-00  
(Replaces Carrier #: 10-00328-00)

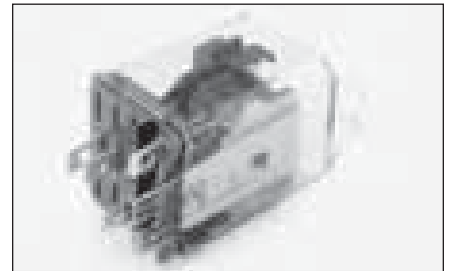

### Relay, Glow Plug

Order Part #: P-10-00281-00  
(Replaces Carrier #: 10-00281-00)



### Relay, Mtr Overload

Order Part #: P-133256  
(Replaces Carrier #: 133256)

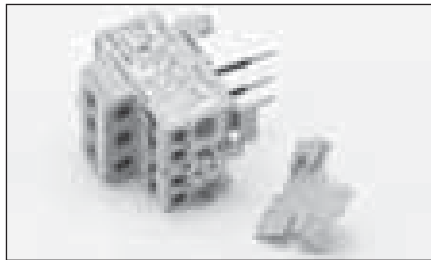

### Relay, Overload

Order Part #: P-10-60044-00  
(Replaces Carrier #: 10-60044-00)

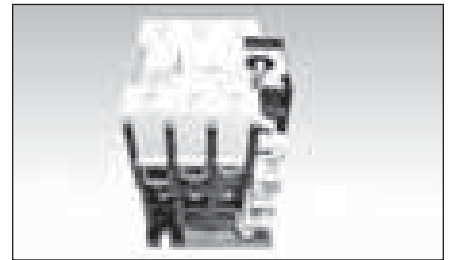

### Relay, Overload

Order Part #: P-10-60049-00  
(Replaces Carrier #: 10-60049-00)

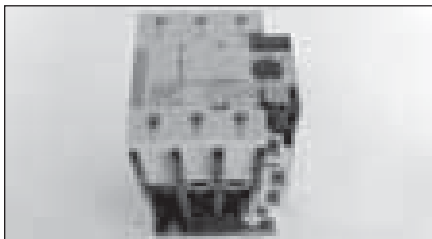

### Relay, Overload

Order Part #: P-10-60049-01  
(Replaces Carrier #: 10-60049-01)

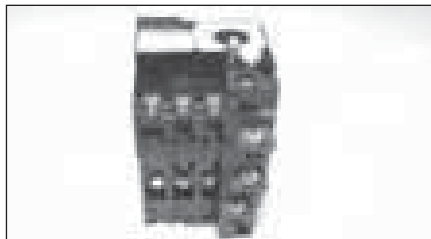

### Relay, Overload

Order Part #: P-10-60056-00  
(Replaces Carrier #: 10-60056-00)

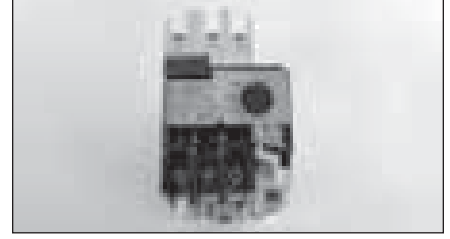

### Relay, Overload

Order Part #: P-12-60010-00  
(Replaces Carrier #: 12-60010-00)

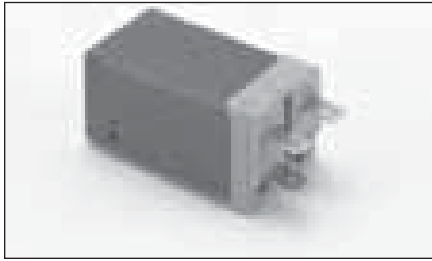

**Relay, Start 115V**  
 Order Part #: P-10-60012-01  
 (Replaces Carrier #: 10-60012-01)



**Relay, Start (230V)**  
 Order Part #: P-10-60012-00  
 (Replaces Carrier #: 10-60012-00)



**Relay, Start, 230V Single PH**  
 Order Part #: P-10-00424-01  
 (Replaces Carrier #: 10-00424-01)

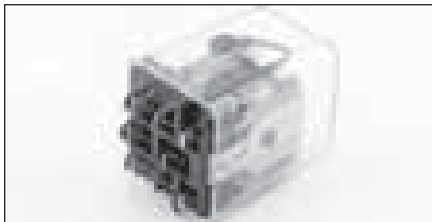

**Relay, Starter Solenoid (12V)**  
 Order Part #: P-10-00220-00  
 (Replaces Carrier #: 10-00220-00)

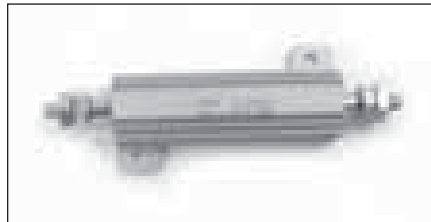

**Resistor (50W)**  
 Order Part #: P-22-01427-00  
 (Replaces Carrier #: 22-01427-00)

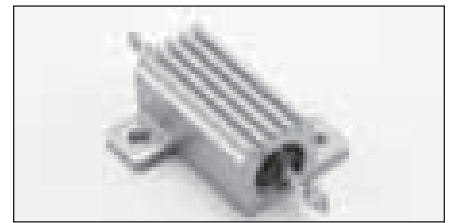

**Resistor, 68 OHMS**  
 Order Part #: P-22-60184-00  
 (Replaces Carrier #: 22-60184-00)



**Resistor, Alternator**  
 Order Part #: P-30-00393-35  
 (Replaces Carrier #: 30-00393-35)

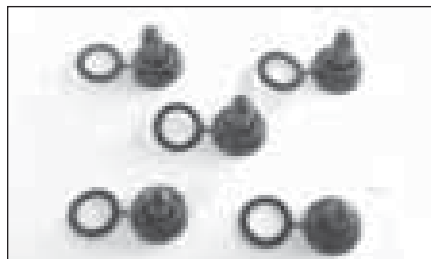

**Seal, Boot**  
 Order Part #: P-66U2-1081  
 (Replaces Carrier #: 66U2-1081)

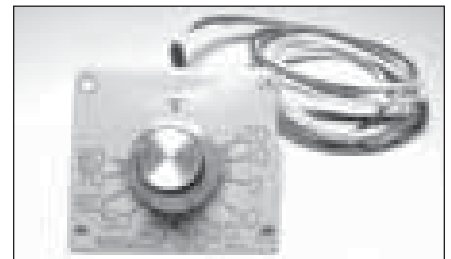

**Selector, Temp (F)**  
 Order Part #: P-22-01189-00SV  
 (Replaces Carrier #: 22-01189-00SV)



**Sender, Oil Pressure**  
 Order Part #: P-12-00258-01  
 (Replaces Carrier #: 12-00258-01)



**Sender, Water Temp**  
 Order Part #: P-12-00098-04  
 (Replaces Carrier #: 12-00098-04)



**Sensor**  
 Order Part #: P-22-60167-00  
 (Replaces Carrier #: 22-60167-00)

## Truck & Trailer Parts – ELECTRICAL



### Sensor (SAS)

Order Part #: P-22-01636-00  
(Replaces Carrier #: 22-01636-00)

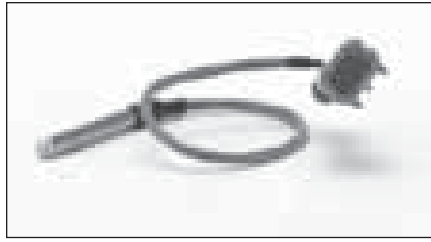

### Sensor RAS

Order Part #: P-12-60001-20  
(Replaces Carrier #: 12-60001-20)



### Sensor (RAS)

Order Part #: P-22-01940-00  
(Replaces Carrier #: 22-01940-00)



### SAS Sensor

Order Part #: P-22-60009-01  
(Replaces Carrier #: 22-60009-01)



### Sensor, Combination

Order Part #: P-12-00500-01SV  
(Replaces Carrier #: 12-00500-01SV)



### Sensor, Digital (TH)

Order Part #: P-12-01075-01  
(Replaces Carrier #: 12-01075-01)

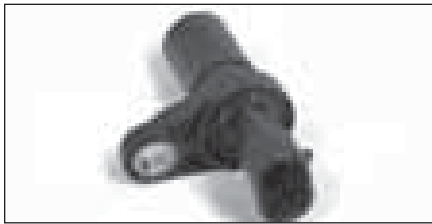

### Sensor, RPM

Order Part #: P-12-00448-01  
(Replaces Carrier #: 12-00448-01)

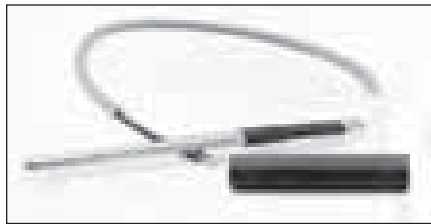

### Sensor, Thermostat

Order Part #: P-12-01072-11SV  
(Replaces Carrier #: 12-01072-11SV)

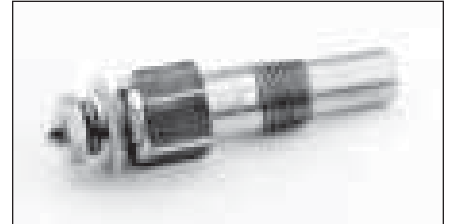

### Sensor, Water Temp

Order Part #: P-12-00257-00  
(Replaces Carrier #: 12-00257-00)



### Switch, Air Pressure

Order Part #: P-12-01039-08  
(Replaces Carrier #: 12-01039-08)

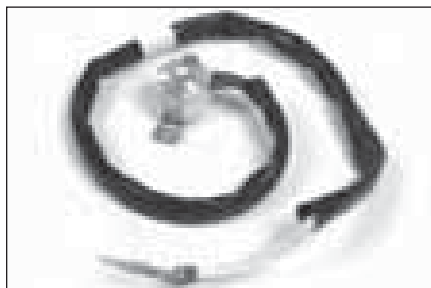

### Switch, Defrost Termination

Order Part #: P-14-60055-00  
(Replaces Carrier #: 14-60055-00)



### Switch, HPCO (HP-1) R22

Order Part #: P-12-00309-01  
(Replaces Carrier #: 12-00309-01)

**STARTERS AND SOLENOIDS CAN BE FOUND IN THE ENGINE SECTION.**

## Truck & Trailer Parts – ELECTRICAL

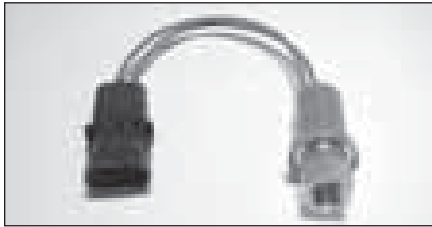

### Switch, Pressure

Order Part #: P-12-60015-01  
(Replaces Carrier #: 12-60015-01)

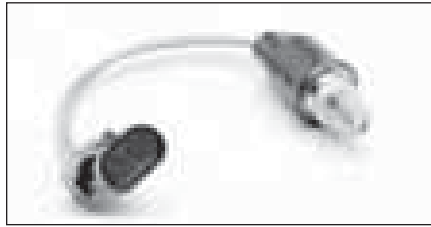

### Switch, Pressure (350PSIG, HPS)

Order Part #: P-12-00309-00  
(Replaces Carrier #: 12-00309-00)

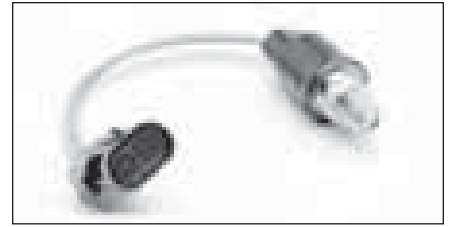

### Switch, Pressure (489 PSIG, HP-1)

Order Part #: P-12-00309-04  
(Replaces Carrier #: 12-00309-04)



### Switch, Pressure (HP-1)

Order Part #: P-12-00255-00  
(Replaces Carrier #: 12-00255-00)

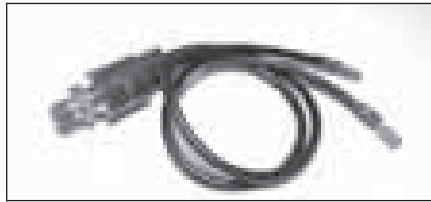

### Switch, Pressure (HP-1)

Order Part #: P-66U1-6942-1  
(Replaces Carrier #: 66U1-6942-1)



### Switch, Pressure (HP-2)

Order Part #: P-12-00299-16  
(Replaces Carrier #: 12-00299-16)



### Switch, Pressure (HP-2)

Order Part #: P-12-01012-00  
(Replaces Carrier #: 12-01012-00)



### Switch, Pressure (Oil)

Order Part #: P-10-00316-00  
(Replaces Carrier #: 10-00316-00)



### Switch, Pressure (Oil)

Order Part #: P-10-01169-00  
(Replaces Carrier #: 10-01169-00)



### Switch, Pressure (Oil)

Order Part #: P-10-01169-01  
(Replaces Carrier #: 10-01169-01)



### Switch, Pressure (Oil)

Order Part #: P-12-00592-00  
(Replaces Carrier #: 12-00592-00)

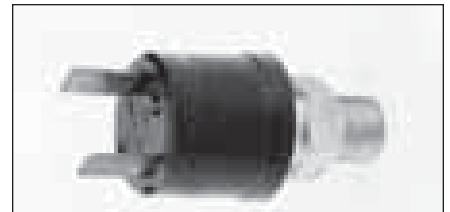

### Switch, Pressure

Order Part #: P-12-00254-00  
(Replaces Carrier #: 12-00254-00)



### Switch, Pressure, Head (HP-2)

Order Part #: P-12-00255-02  
(Replaces Carrier #: 12-00255-02)

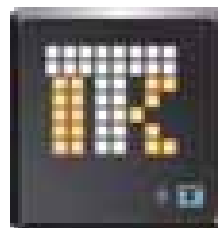

### Status Light, LED

Order Part #: P-76-02000-00  
(Replaces Carrier #: 76-02000-00)

### Wiring Harness for Standard /Summit

Order Part #: P-22-02843-00  
(Replaces Carrier #: 22-02843-00)

## Truck & Trailer Parts – ELECTRICAL

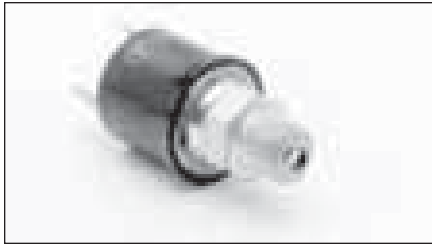

### Switch, Pressure

Order Part #: P-12-00254-01  
(Replaces Carrier #: 12-00254-01)



### Switch, Pressure

Order Part #: P-12-00255-01  
(Replaces Carrier #: 12-00255-01)



### Switch, Pressure

Order Part #: P-12-00255-03  
(Replaces Carrier #: 12-00255-03)



### Switch, Pressure

Order Part #: P-12-01022-01  
(Replaces Carrier #: 12-01022-01)



### Switch, Pressure

Order Part #: P-12-60032-00  
(Replaces Carrier #: 12-60032-00)



### Switch, Pressure

Order Part #: P-12-60032-01  
(Replaces Carrier #: 12-60032-01)



### Switch, Pressure

Order Part #: P-12-60032-02  
(Replaces Carrier #: 12-60032-02)



### Switch, Start/Stop

Order Part #: P-22-02751-00  
(Replaces Carrier #: 22-02751-00)

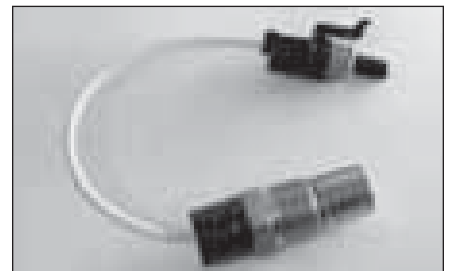

### Switch, Temperature (Water)

Order Part #: P-12-60000-00  
(Replaces Carrier #: 12-60000-00)



### Switch, Thermostat (HTT)

Order Part #: P-66U1-6912-3  
(Replaces Carrier #: 66U1-6912-3)



### Switch, Thermostat

Order Part #: P-140507  
(Replaces Carrier #: 140507)



### Switch, Toggle (Ele/Eng)

Order Part #: P-10-01129-06SV  
(Replaces Carrier #: 10-01129-06SV)

## Truck & Trailer Parts – ELECTRICAL

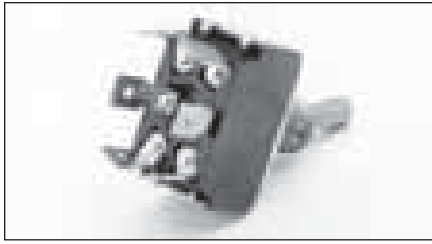

### Switch, Toggle (Glow/Defrost)

Order Part #: P-10-01129-08SV  
(Replaces Carrier #: 10-01129-08SV)

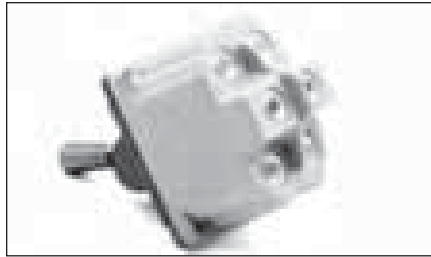

### Switch, Toggle (GP)

Order Part #: P-10-00223-00  
(Replaces Carrier #: 10-00223-00)



### Switch, Toggle (Hi Air/Normal)

Order Part #: P-10-01129-02  
(Replaces Carrier #: 10-01129-02)



### Switch, Toggle (IGN)

Order Part #: P-10-00222-00  
(Replaces Carrier #: 10-00222-00)



### Switch, Toggle (ON/OFF)

Order Part #: P-10-00237-00  
(Replaces Carrier #: 10-00237-00)



### Switch, Toggle (RS)

Order Part #: P-10-01164-02  
(Replaces Carrier #: 10-01164-02)

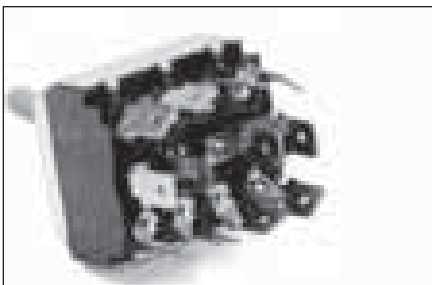

### Switch, Toggle, On/Off (EB)

Order Part #: P-10-01129-07SV  
(Replaces Carrier #: 10-01129-07SV)



### Switch, Toggle

Order Part #: P-10-00327-00  
(Replaces Carrier #: 10-00327-00)



### Switch, Toggle

Order Part #: P-10-01129-01SV  
(Replaces Carrier #: 10-01129-01SV)



### Switch, Toggle

Order Part #: P-10-01129-15SV  
(Replaces Carrier #: 10-01129-15SV)



### Switch, Toggle

Order Part #: P-10-01129-04SV  
(Replaces Carrier #: 10-01129-04SV)

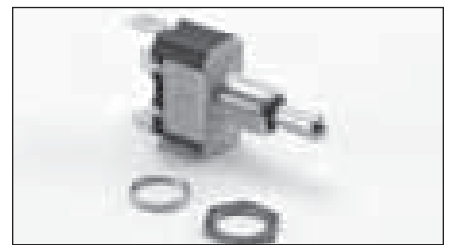

### Switch, Toggle

Order Part #: P-10-01129-16SV  
(Replaces Carrier #: 10-01129-16SV)

## Truck & Trailer Parts – ELECTRICAL

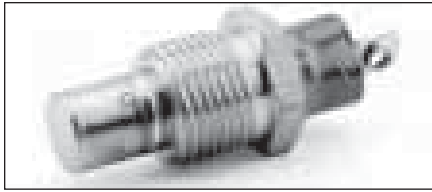

### Switch, Water Temp (110C/230F)

Order Part #: P-10-00158-02  
(Replaces Carrier #: 10-00158-02)

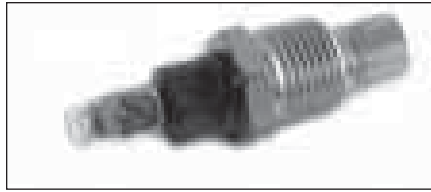

### Switch, Water Temp

Order Part #: P-10-00261-00SV  
(Replaces Carrier #: 10-00261-00SV)

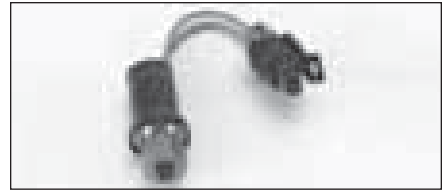

### Swith, Low Pressure

Order Part #: P-12-60015-04  
(Replaces Carrier #: 12-60015-04)



### Thermistor, Comp Dis Temp (CDT)

Order Part #: P-12-00284-00  
(Replaces Carrier #: 12-00284-00)



### Thermistor, RAS/SAS (XL, XT, XTC)

Order Part #: P-12-00523-01  
(Replaces Carrier #: 12-00523-01)

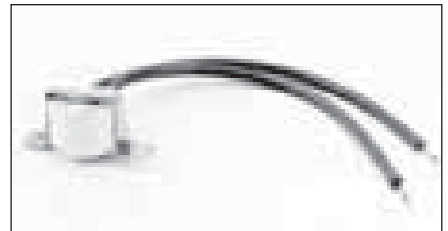

### Thermostat, Def. Termination

Order Part #: P-12-00228-07  
(Replaces Carrier #: 12-00228-07)



### Thermometer, POCKET Dial (F)

Order Part #: P-T160

### Thermometer, POCKET Dial (C)

Order Part #: P-TC70



### Thermometer, POCKET Digital(C)

Order Part #: P-300AC

### Thermometer, POCKET Digital(F)

Order Part #: P-300A



### Thermostat, Defrost

Order Part #: P-12-00256-21  
(Replaces Carrier #: 12-00256-21)



### Transducer, W/ Harness (XTC)

Order Part #: P-12-00352-03SV  
(Replaces Carrier #: 12-00352-03SV)



### Transducer, W/ Harness

Order Part #: P-12-00283-00SV  
(Replaces Carrier #: 12-00283-00SV)

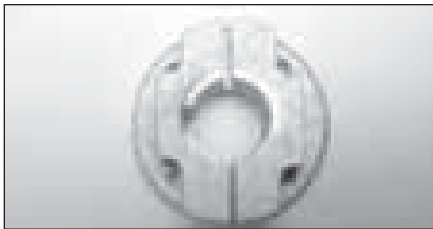

**Adapter, Condenser Fan**  
 Order Part #: P-48-60001-00  
 (Replaces Carrier #: 48-60001-00)

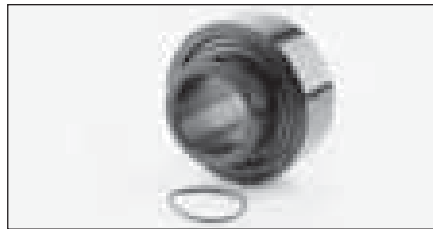

**Bearing**  
 Order Part #: P-04-00053-00SV  
 (Replaces Carrier #: 04-00053-00SV)

**ELECTRONIC  
 DOOR SWITCH**

Low-profile switch  
 automatically stops and  
 restarts reefer when door  
 is opened and closed.

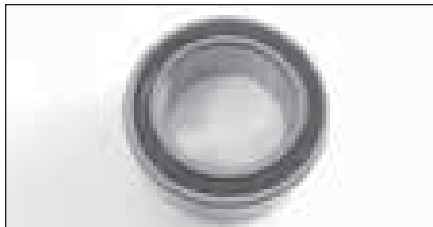

**Bearing, Clutch**  
 Order Part #: P-50-50050-03  
 (Replaces Carrier #: 50-50050-03)

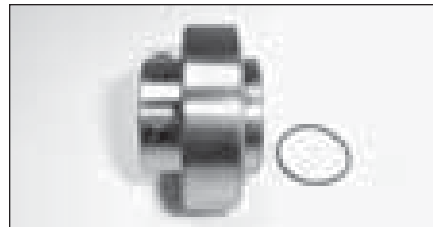

**Bearing, Fan Shaft**  
 Order Part #: P-04-00041-00SV  
 (Replaces Carrier #: 04-00041-00SV)



**Bearing, Fan Shaft**  
 Order Part #: P-04-60008-29  
 (Replaces Carrier #: 04-60008-29)

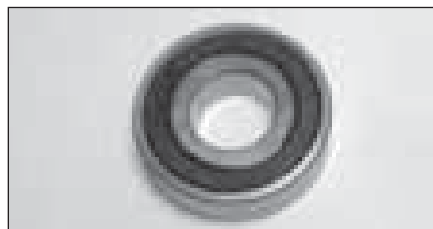

**Bearing, Idler**  
 Order Part #: P-48-01039-23  
 (Replaces Carrier #: 48-01039-23)

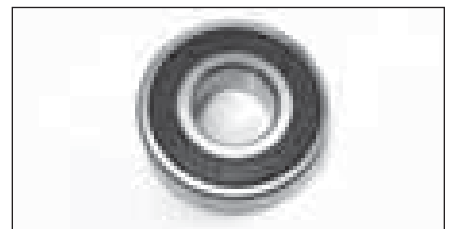

**Bearing, Idler**  
 Order Part #: P-04-00018-00  
 (Replaces Carrier #: 04-00018-00)

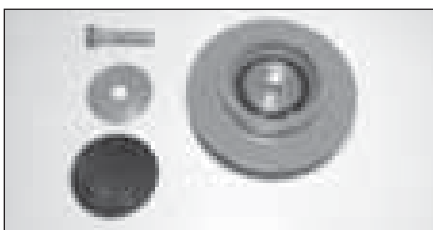

**Bearing, Idler**  
 Order Part #: P-50-01152-25SV  
 (Replaces Carrier #: 50-01152-25SV)

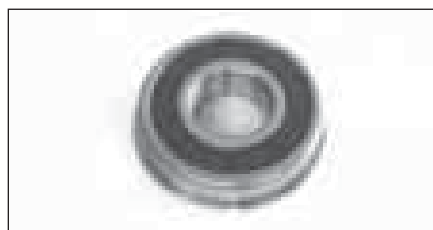

**Bearing, Jackshaft**  
 Order Part #: P-04-00054-00  
 (Replaces Carrier #: 04-00054-00)

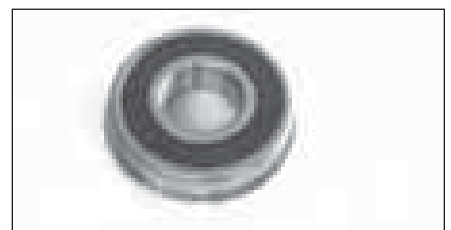

**Bearing, Jackshaft**  
 Order Part #: P-04-50015-00  
 (Replaces Carrier #: 04-50015-00)

# Truck & Trailer Parts – DRIVE

## MASTER BELT CROSS REFERENCE

MODEL	APPLICATION	ORDER TK NO.
Advantage	Belt, Water Pump-----	P-50-00162-04
	Belt, Drive To Jackshaft (NDJ)-----	P-50-00178-00
	Belt, Alternator To Jackshaft-----	P-50-00179-00
	Belt, Jackshaft To Fan Shaft-----	P-50-01161-02
	Belt, Jackshaft To Fan Shaft-----	P-50-00183-01
Eagle	Belt, Water Pump-----	P-50-00162-04
	Belt, Drive To Jackshaft-----	P-50-00162-05
	Belt, Clutch To Jackshaft-----	P-50-00162-06
	Belt, Jackshaft To Condenser Fan-----	P-50-01001-01
	Belt Set, Motor To Clutch-----	P-50-01101-01
EuroPhoenix	Belt, Electric Motor-----	P-50-00178-05
	Belt, Double V (Eng/Comp)-----	P-50-01166-00
	Belt, Motor to Alternator-----	P-50-60288-00
Extra	Belt, Water Pump-----	P-50-00162-04
	Belt, Condenser Fan-----	P-50-00178-07
	Belt, Compressor Drive-----	P-50-00178-08
	Belt Set, Motor To Compressor-----	P-50-00178-51
	Belt, Multi Temp-----	P-50-00179-20
Extra XT	Belt, Alternator / Water Pump-----	P-50-00162-18
	Belt, Compressor Drive-----	P-50-00178-08
	Belt, Upper Drive-----	P-50-00178-24
Genesis R70	Belt Set, Engine To Compressor-----	P-50-00162-53
	Belt, Alternator-----	P-50-60006-02
	Belt, Compressor to Elec. Motor-----	P-50-60007-00
	Belt, Water Pump-----	P-50-60197-04
Genesis R90	Belt, Water Pump-----	P-25-33023-00
	Belt, Double V (Eng/Comp)-----	P-50-01166-00
	Belt, Comp to Elect Motor-----	P-50-00178-55
	Belt, Alternator/Generator-----	P-50-00179-19
Genesis TM900/1000	Belt, Water Pump-----	P-50-00162-04
	Belt, Condenser Fan-----	P-50-00178-07
	Belt, Compressor Drive-----	P-50-00178-08
	Belt, Alternator-----	P-50-00179-20
Genesis Multi-Temp TM900/1000	Belt, Water Pump (134TV)-----	P-50-00162-04
	Belt, Water Pump (134DI)-----	P-50-00162-22
	Belt, Condenser Fan S/N HAD90547903-HAY90594028-----	P-50-00178-07
	Belt, Compressor Drive-----	P-50-00178-08
	Belt, Generator-----	P-50-00178-18
	Belt, Alternator-----	P-50-00179-20
	Belt, Generator (Multi-Temp)-----	P-50-01001-03
Genesis TR1000	Belt, Standby Motor (NDD)-----	P-50-00178-51
	Belt, Standby Motor (NDC)-----	P-50-00162-14
	Belt, Water Pump-----	P-50-00162-04

(continued)

**MASTER BELT CROSS REFERENCE (continued)**

<b>MODEL</b>	<b>APPLICATION</b>	<b>ORDER TK NO.</b>
GenSet	Belt, Water Pump-----	P-50-00162-04
	Belt, Alternator-----	P-50-00204-01
Maxima	Belt Set, Motor To Compressor -----	P-50-00178-51
	Belt Set, Classical -----	P-50-00178-56
	Belt, Vent Box-----	P-50-00179-57
	Belt, Water Pump (Maxima 2)-----	P-50-60197-06
	Belt, Clutch-----	P-50-60198-55
	Belt, Motor to Alternator-----	P-50-60288-00
	Belt, Vent Box (Maxima)-----	P-50-60288-01
	Belt, Electric Motor-----	P-50-60297-00
Metrobird	Belt Set, Motor to Compressor -----	P-50-00179-51
Optima	Belt, Alternator-----	P-50-00162-08
	Belt, Water Pump-----	P-50-00162-10
	Belt, Condenser Fan-----	P-50-00178-07
	Belt, Compressor Drive -----	P-50-00178-12
Solara	Belt, Water Pump-----	P-50-00162-10
Supra 922/944	Belt, Water Pump-----	P-25-33023-00
	Belt Set, Electric Motor -----	P-50-00178-58
	Belt, Double V (Eng/Comp)-----	P-50-01166-00
	Belt, Alternator-----	P-50-60006-02
Supra 844	Belt Set, Engine to Compressor -----	P-50-00179-56
	Belt, Comp to Standby Motor -----	P-50-00179-54
	Belt, Water Pump-----	P-50-60197-04
Supra 622/644 722/744	Belt Set, Engine To Compressor -----	P-50-00162-53
	Belt, Alternator-----	P-50-60006-02
	Belt, Elec. Motor To Compressor -----	P-50-60007-00
	Belt, Water Pump-----	P-50-60197-04
	Tension Support Kit, Belt -----	P-79-02322-01
Supra 550	Belt, Water Pump-----	P-25-34856-00
Supra 422	Belt, Water Pump-----	P-25-34856-00
	Belt, Alternator-----	P-50-00179-03
	Belt, Compressor To Motor-----	P-50-00179-05
	Belt, Engine To Compressor-----	P-50-60198-44
	Tension Support Kit, Belt -----	P-79-02322-01
Thunderbird	Belt, Alternator (Early Model) -----	P-50-00162-03
	Belt, Water Pump-----	P-50-00162-04
	Belt, Drive To Jackshaft (NDJ) -----	P-50-00178-00
	Belt, Drive To Jackshaft (NDF) -----	P-50-00178-01
	Belt, Alternator To Jackshaft -----	P-50-00179-00
	Belt, Condenser Fan (Early Model) -----	P-50-01001-11
	Belt Set, Motor To Clutch (NDF) -----	P-50-01101-01
	Belt, Jackshaft To Fan Shaft-----	P-50-01161-02

**DRIVE**

(continued)

# Truck & Trailer Parts – DRIVE

## MASTER BELT CROSS REFERENCE (continued)

MODEL	APPLICATION	ORDER TK NO.
Ultima	Belt, Water Pump-----	P-50-00162-04
	Belt, Compressor Drive -----	P-50-00178-16
	Belt, Condenser Fan-----	P-50-00178-20
	Belt, Alternator-----	P-50-00179-22
Ultima (XTC)	Belt, Alt to Water Pump-----	P-50-00162-22
	Belt, Cross Section Lower Drive -----	P-50-00178-19
	Belt, Cross Section Upper Drive -----	P-50-00178-26
Ultra	Belt, Water Pump-----	P-50-00162-04
	Belt, Alternator-----	P-50-00162-08
	Belt, Condenser Fan-----	P-50-00178-07
	Belt, Compressor Drive -----	P-50-00178-08
	Belt, Generator (Muti-Temp) -----	P-50-00178-10
	Belt, Alternator (105 Amp) -----	P-50-00178-13
	Belt, Diesel/Electric (NDM) -----	P-50-00178-23
	Belt Set, Standby Motor (NDM)-----	P-50-00178-51
	Belt, Alternator (3.5" Pulley) -----	P-50-00179-09
	Belt, Alternator (3" Pulley) -----	P-50-00179-20
Ultra XL	Belt, Alternator to Water Pump -----	P-50-00162-22
	Belt, Condenser Fan-----	P-50-00178-07
	Belt, Compressor Drive -----	P-50-00178-08
	Belt Set, Standby Motor -----	P-50-00178-51
	Belt, Alternator-----	P-50-00179-20
Ultra XT	Belt, Alternator to Water Pump -----	P-50-00162-22
	Belt, Cross Section Lower Drive -----	P-50-00178-19
	Belt, Cross Section,Upper Drive -----	P-50-00178-24
Ultra XTC	Belt, Alternator to Water Pump -----	P-50-00162-22
	Belt, Cross Section Lower Drive -----	P-50-00178-19
	Belt, Cross Section, Upper Drive-----	P-50-00178-24

## OTHER BELTS ALSO AVAILABLE

CARRIER NO.	DESCRIPTION	ORDER TK NO.
50-00162-00	Belt, (GC Model)	P-50-00162-00
50-00162-02	Belt	P-50-00162-02
50-00162-07	Belt	P-50-00162-07
50-00162-20	Belt	P-50-00162-20
50-00178-04	Belt	P-50-00178-04
50-00178-14	Belt	P-50-00178-14
50-00179-52	Belt	P-50-00179-52
50-01001-00	Belt	P-50-01001-00
50-01001-15	Belt	P-50-01001-15
50-01086-06	Belt, Matched Pair	P-50-01086-06
50-01094-00	Belt	P-50-01094-00
50-01094-02	Belt	P-50-01094-02
50-01094-03	Belt	P-50-01094-03
50-60198-11	Belt	P-50-60198-11

DRIVE



**Bolt, Shoulder**

Order Part #: P-48-00058-02  
(Replaces Carrier #: 48-00058-02)

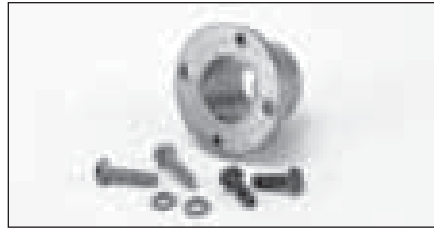

**Bushing, Split Taper**

Order Part #: P-04-00122-02  
(Replaces Carrier #: 04-00122-02)

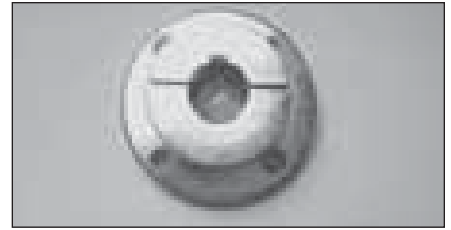

**Bushing, Split Taper**

Order Part #: P-04-00122-10  
(Replaces Carrier #: 04-00122-10)



**Bushing, Split Taper**

Order Part #: P-04-00122-15  
(Replaces Carrier #: 04-00122-15)



**Bushing, Split Taper**

Order Part #: P-04-00122-30SV  
(Replaces Carrier #: 04-00122-30SV)



**Clutch (Ultima)**

Order Part #: P-50-00228-02SV  
(Replaces Carrier #: 50-00228-02SV)



**Clutch Supra 6/7**

Order Part #: P-50-01165-01-B  
(Replaces Carrier #: 50-01165-01)



**Clutch, Supra 844/422**

Order Part #: P-50-60029-00-B  
(Replaces Carrier #: 50-60029-00)



**Clutch, Supra 922/944**

Order Part #: P-50-50051-04-B  
(Replaces Carrier #: 50-50051-04)



**Clutch, 2/A Groove (VP Truck)**

Order Part #: P-AC501-292  
(Replaces Carrier #: AC501-292)



**Clutch, 8 Groove (VP Truck)**

Order Part #: P-AC501-291  
(Replaces Carrier #: AC501-291)



**Clutch, A/B Groove 12V (VP Truck)**

Order Part #: P-17-31252-00  
(Replaces Carrier #: 17-31252-00)

## Truck & Trailer Parts – DRIVE



**PG Specific**

**Coil, Clutch PG**  
 Order Part #: P-50-00215-25SVPG  
 (Only for PG Clutch  
 Assembly. P-50-00215-01SV)

**Clutch Assembly  
 (For Gearbox P-50-00214-03)**  
 Order Part #: P-50-00215-01SV  
 (Replaces Carrier #: 50-00215-01SV)

**WORKS FOR BOTH CARRIER  
 AND PG CLUTCH**



**Hardware, Clutch Package**  
 Order Part #: P-50-00215-23  
 (Replaces Carrier #: 50-00215-23)

### CLUTCH TOOLS



**Socket, Wrench  
 (Gearbox Clutch)**  
 Order Part #: P-07-00303-01  
 (Replaces Carrier #: 07-00303-01)



**Socket, Wrench  
 (XTC Clutch)**  
 Order Part #: P-07-00303-02  
 (Replaces Carrier #: 07-00303-02)



**Wrench, Spanner  
 Clutch (XTC)**  
 Order Part #: P-07-00396-01  
 (Replaces Carrier #: 07-00396-01)



**Coil, Clutch (VP Truck)**  
 Order Part #: P-17-31307-00  
 (Replaces Carrier #: 17-31307-00)



**Clutch, XTC**  
 Order Part #: P-50-00236-05  
 (Replaces Carrier #: 50-00236-05)

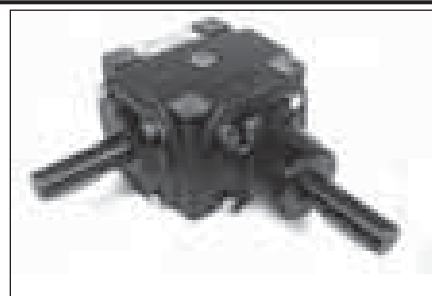

**Drive Assembly, Gear Box**  
 Order Part #: P-50-00227-01  
 (Replaces Carrier #: 50-00227-01)



**Drive Assembly, Gear Box**  
 Order Part #: P-50-00214-03  
 (Replaces Carrier #: 50-00214-03)

#### PG PARTS GEAR BOXES BENEFITS:

- Spiral cut gears (vs. straight cut) to offer higher HP and RPM capacity and reduces 'foaming'
- Tapered roller bearings (vs. ball) for better shaft support and gear life
- Viton seals (vs. Nitrile) for longer seal life
- High temperature synthetic oil to reduce 'foaming'
- No venting needed

**Carrier Gear Box  
Parts**

Use Only With  
Carrier Gear Boxes

Note:

Not For Use on PG Gear Box  
P-50-00214-03  
or P-50-00227-01

**Shim (0.002) (9/Pk)**

Order Part #: P-50-00214-24  
(Replaces Carrier #: 50-00214-24)

**Shim (0.005) (9/Pk)**

Order Part #: P-50-00214-23  
(Replaces Carrier #: 50-00214-23)

**Bearing, Ball (Drive Gear)**

Order Part #: P-50-00214-31  
(Replaces Carrier #: 50-00214-31)

**Bearing, Ball (Drive Gear)**

Order Part #: P-50-00214-32  
(Replaces Carrier #: 50-00214-32)

**Kit Shaft, Seal (Key Incl.)**

Order Part #: P-50-00214-55SV  
(Replaces Carrier #: 50-00214-55SV)

**Kit Shaft, Seal  
(Shaft & Dust Seals)**

Order Part #: P-50-50057-00  
(Replaces Carrier #: 50-50057-00)



**Fan**

Order Part #: P-38-60018-00  
(Replaces Carrier #: 38-60018-00)

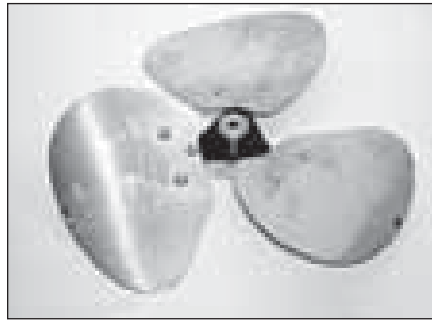

**Fan, Condenser**

Order Part #: P-38-00550-00  
(Replaces Carrier #: 38-00550-00)



**Fan, Condenser**

Order Part #: P-38-60000-01  
(Replaces Carrier #: 38-60000-01)

**PG Parts Condenser**

**Fan Kit Benefits:**

- Unique airfoil profile blade for greater efficiencies and lower noise
- Corrosion-resistant materials
- Lightweight
- Uses individual blades that can be easily replaced

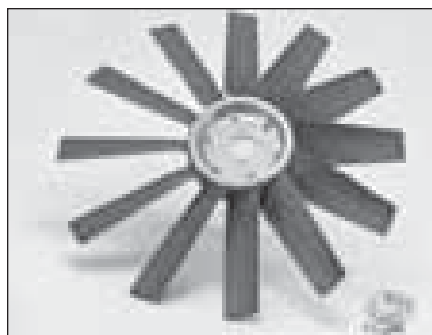

**Fan, Condenser**

Order Part #: P-38-00528-00SV  
(Replaces Carrier #: 38-00528-00SV)

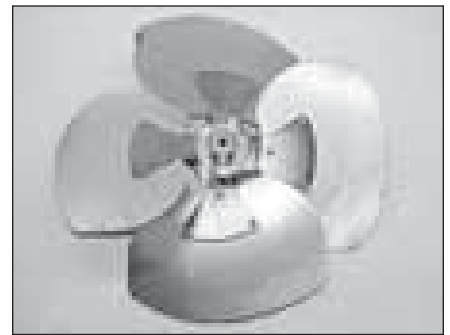

**Fan, Condenser**

Order Part #: P-38-60017-00  
(Replaces Carrier #: 38-60017-00)



**Fan, Evap**

Order Part #: P-38-60009-00  
(Replaces Carrier #: 38-60009-00)

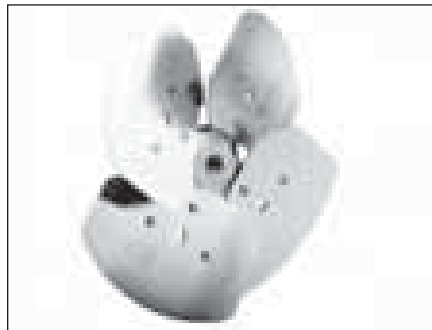

**Fan, Evaporator**

Order Part #: P-38-60010-00  
(Replaces Carrier #: 38-60010-00)



**Gear Package**

Order Part #: P-48-50005-00-B  
(Replaces Carrier #: 48-50005-00)

## Truck & Trailer Parts – DRIVE

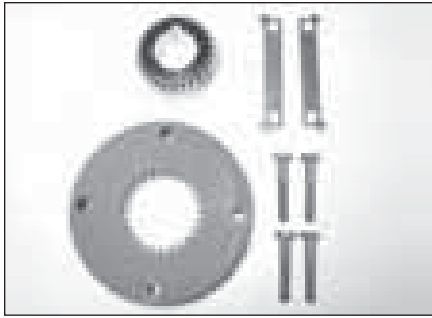

### Gear Package, U-Drive

Order Part #: P-48-50003-00-B  
(Replaces Carrier #: 48-50003-00)

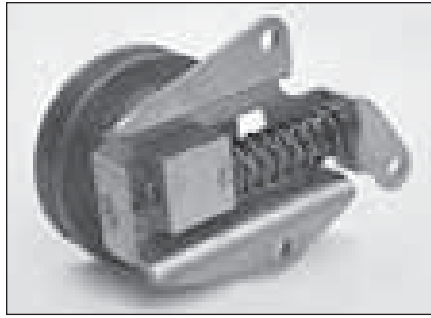

### Idler Assy

Order Part #: P-25-34424-00  
(Replaces Carrier #: 25-34424-00)



### Idler Assy

Order Part #: P-50-01152-00  
(Replaces Carrier #: 50-01152-00)

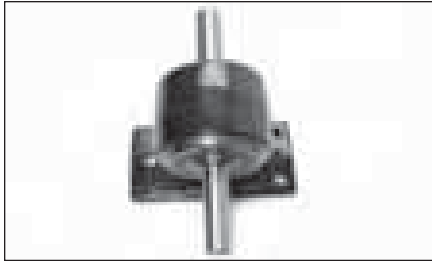

### Jackshaft

Order Part #: P-79-01472-00  
(Replaces Carrier #: 79-01472-00)



### Key, Fanshaft 1/4"

Order Part #: P-50-00229-24  
(Replaces Carrier #: 50-00229-24)

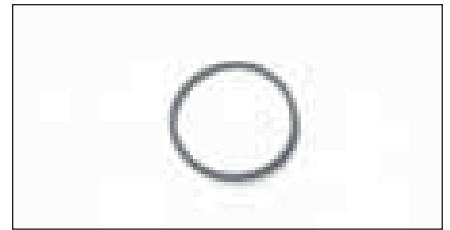

### O-Ring, Fan Shaft Housing

Order Part #: P-42-01134-00  
(Replaces Carrier #: 42-01134-00)

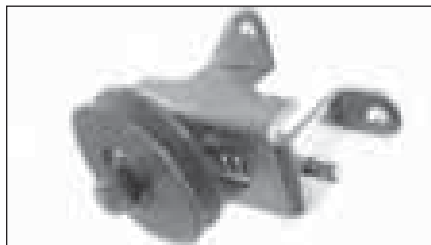

### Pulley Assembly, Idler Tensioner

Order Part #: P-25-15450-00  
(Replaces Carrier #: 25-15450-00)



### Pulley Assy, Idler

Order Part #: P-50-60021-00  
(Replaces Carrier #: 50-60021-00)



### Pulley Assy, Water Pump Idler

Order Part #: P-48-00058-01  
(Replaces Carrier #: 48-00058-01)



### Pulley, Alternator

Order Part #: P-50-01127-03  
(Replaces Carrier #: 50-01127-03)

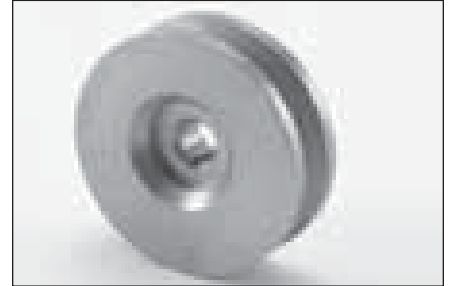

### Pulley, Alternator

Order Part #: P-50-01127-12  
(Replaces Carrier #: 50-01127-12)



**Pulley, Idler Assembly**  
 Order Part #: P-50-60005-00  
 (Replaces Carrier #: 50-60005-00)

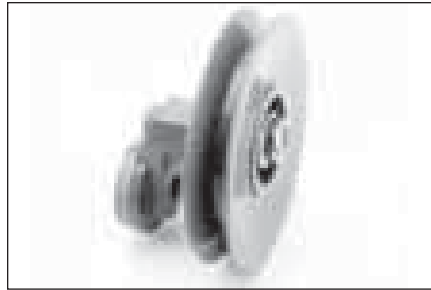

**Pulley, Idler**  
 Order Part #: P-48-00058-28  
 (Replaces Carrier #: 48-00058-28)

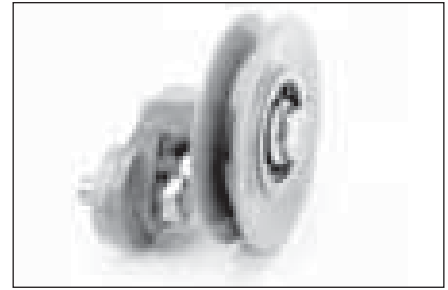

**Pulley, Idler**  
 Order Part #: P-48-00058-29  
 (Replaces Carrier #: 48-00058-29)



**Pulley, Idler**  
 Order Part #: P-50-60156-01  
 (Replaces Carrier #: 50-60156-01)

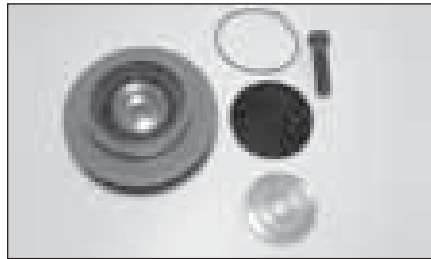

**Pulley, Idler**  
 Order Part #: P-50-01152-20SV  
 (Replaces Carrier #: 50-01152-20SV)

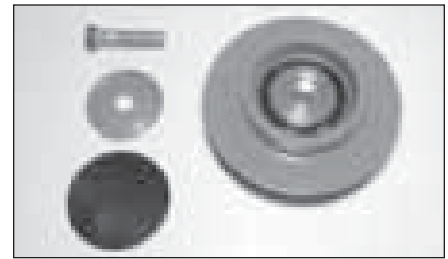

**Pulley, Idler**  
 Order Part #: P-50-01152-22SV  
 (Replaces Carrier #: 50-01152-22SV)

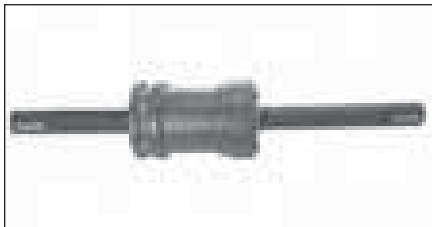

**Shaft Assembly, Fan (Advantage/Thunderbird)**  
 Order Part #: P-50-01150-01SV  
 (Replaces Carrier #: 50-01150-01SV)



**Shaft Assembly, Fan (Ultra/Extra)**  
 Order Part #: P-50-01148-01SV  
 (Replaces Carrier #: 50-01148-01SV)

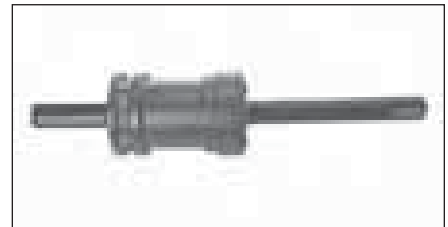

**Shaft, Fan (Ultima)**  
 Order Part #: P-50-00229-00SV  
 (Replaces Carrier #: 50-00229-00SV)

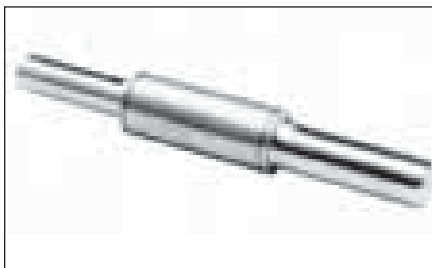

**Shaft, Fan (Advantage)**  
 Order Part #: P-48-00178-00  
 (Replaces Carrier #: 48-00178-00)

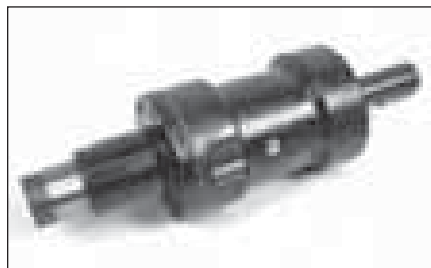

**Shaft, Fan (XTC)**  
 Order Part #: P-50-00232-09SV  
 (Replaces Carrier #: 50-00232-09SV)  
**Also Available: Key, Fan Shaft**  
 Order Part #: P-50-00232-24

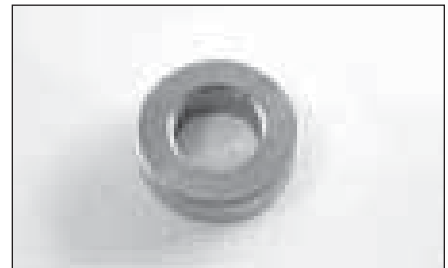

**Spacer, Pulley**  
 Order Part #: P-48-00058-05  
 (Replaces Carrier #: 48-00058-05)



### Belt Guard (Ultra)

Order Part #: P-79-02316-03  
(Replaces Carrier #: 79-02316-03)

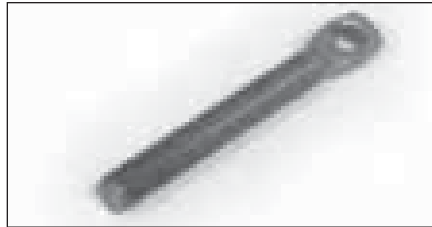

### Bolt

Order Part #: 55-2762  
(Replaces Carrier #: 34-50009-00)

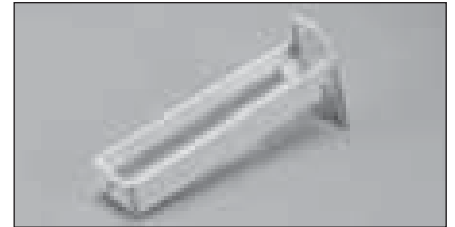

### Bracket Assembly, Idler

Order Part #: P-86-02877-00  
(Replaces Carrier #: 86-02877-00)



### Bracket, Alternator

Order Part #: P-68-07330-00  
(Replaces Carrier #: 68-07330-00)



### Bracket, Alternator

Order Part #: P-86-60372-03  
(Replaces Carrier #: 86-60372-03)



### Bracket, Idler Assembly

Order Part #: P-79-02322-00  
(Replaces Carrier #: 79-02322-00)



### Bracket, J-Bolt

Order Part #: P-68-11089-00  
(Replaces Carrier #: 68-11089-00)



### Bracket, Tension

Order Part #: P-68-07514-01  
(Replaces Carrier #: 68-07514-01)

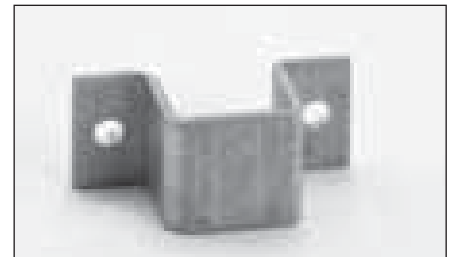

### Bracket, Thermo Switch

Order Part #: P-68-60065-00  
(Replaces Carrier #: 68-60065-00)



### Bushing, 1/4"

Order Part #: P-40-00121-01  
(Replaces Carrier #: 40-00121-01)

## Truck & Trailer Parts – STRUCTURAL

STRUCTURAL

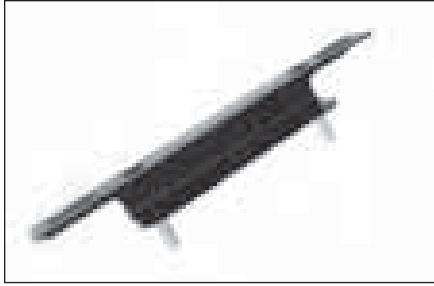

### Channel, Battery Hold Down

Order Part #: P-68-07371-00SV  
(Replaces Carrier #: 68-07371-00SV)

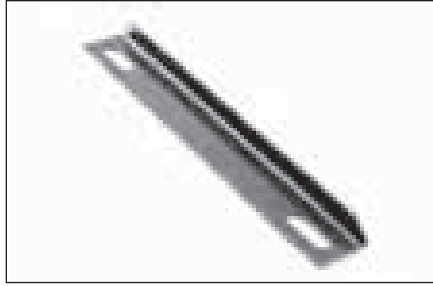

### Channel, Battery Hold Down

Order Part #: P-68-11596-00  
(Replaces Carrier #: 68-11596-00)

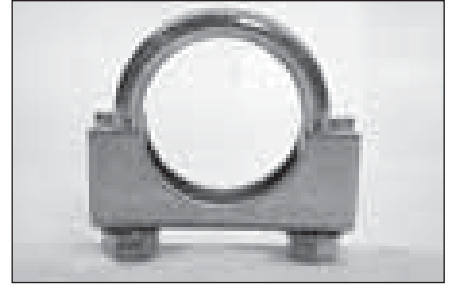

### Clamp, U-Bolt 1.5

Order Part #: P-30-01052-03  
(Replaces Carrier #: 30-01052-03)

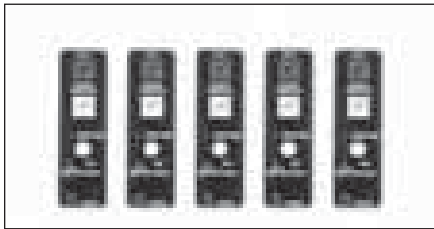

### Decal, Switch

Order Part #: P-62-02448-00  
(Replaces Carrier #: 62-02448-00)

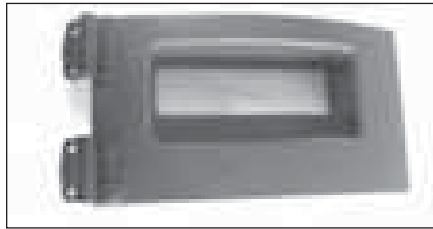

### Door Assembly, Keypad

Order Part #: P-79-02334-25SV  
(Replaces Carrier #: 79-02334-25SV)

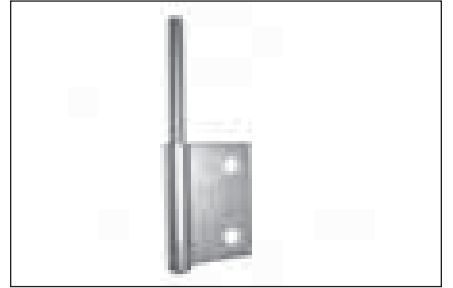

### Hinge

Order Part #: P-44-00236-03  
(Replaces Carrier #: 44-00236-03)



### Hinge, Assembly

Order Part #: P-44-00358-00  
(Replaces Carrier #: 44-00358-00)

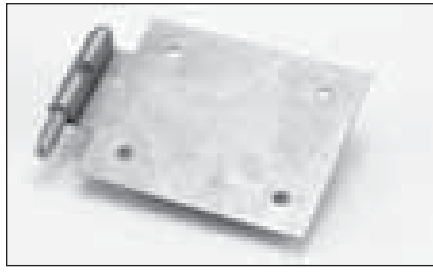

### Hinge, Pin CS

Order Part #: P-44-01152-01  
(Replaces Carrier #: 44-01152-01)

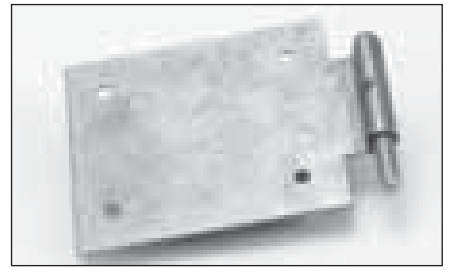

### Hinge, Pin RS

Order Part #: P-44-01152-00  
(Replaces Carrier #: 44-01152-00)



### Hinge, Pin

Order Part #: P-44-00322-01  
(Replaces Carrier #: 44-00322-01)

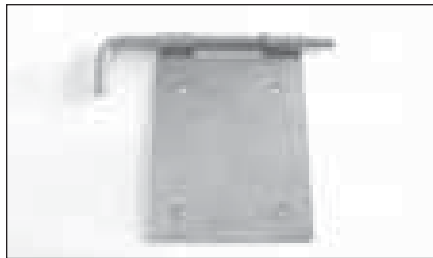

### Hinge, Release (Pull Pin) Curbside

Order Part #: P-44-00320-01  
(Replaces Carrier #: 44-00320-01)

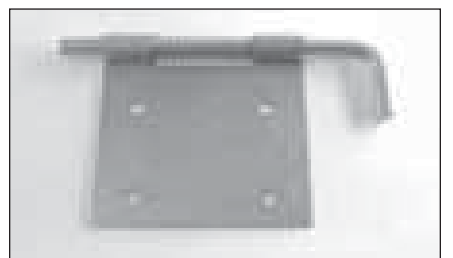

### Hinge, Release (Pull Pin) Curbside

Order Part #: P-44-00323-01  
(Replaces Carrier #: 44-00323-01)

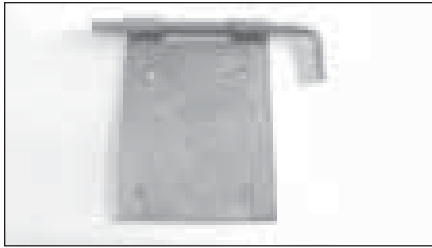

**Hinge, Release (Pull Pin) Roadside**

Order Part #: P-44-00320-00  
(Replaces Carrier #: 44-00320-00)

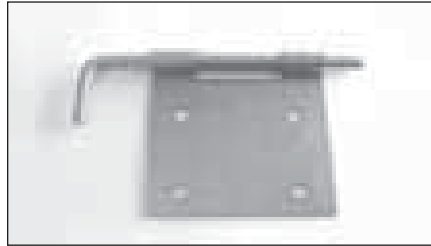

**Hinge, Release (Pull Pin) Roadside**

Order Part #: P-44-00323-00  
(Replaces Carrier #: 44-00323-00)

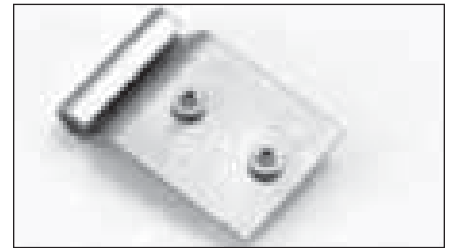

**Hinge, Slip**

Order Part #: P-44-00410-00  
(Replaces Carrier #: 44-00410-00)

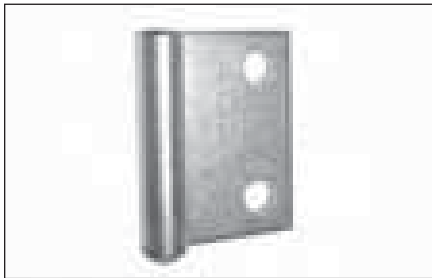

**Hinge, Slip F, Road & Curb**

Order Part #: P-44-00236-02  
(Replaces Carrier #: 44-00236-02)

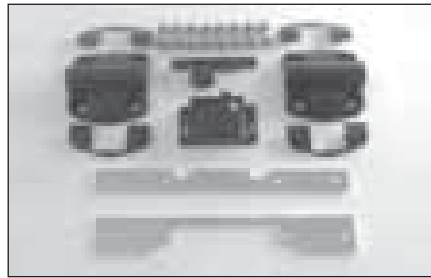

**Hinge Micro Door Kit**

Order Part #: P-76-00523-02  
(Replaces Carrier #: 76-00523-02)

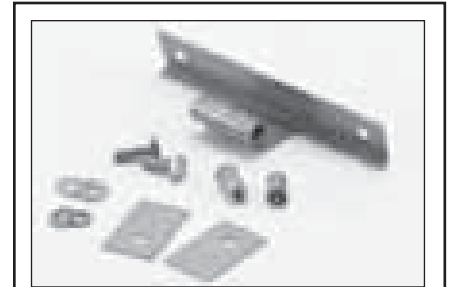

**Hinge Kit, Front Door**

Order Part #: P-76-00570-00  
(Replaces Carrier #: 76-00570-00)

*– ALSO AVAILABLE –*

**Hinge Kit, Side Door**

Order Part #: P-76-00532-00SV  
(Replaces Carrier #: 76-00532-00SV)



**Hold Down, Battery**

Order Part #: P-86-01867-00  
(Replaces Carrier #: 86-01867-00)



**J-Bolt, Battery Hold Down**

Order Part #: P-34-00955-05  
(Replaces Carrier #: 34-00955-05)

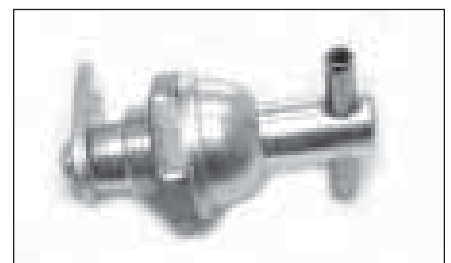

**Latch**

Order Part #: P-44-01133-00  
(Replaces Carrier #: 44-01133-00)

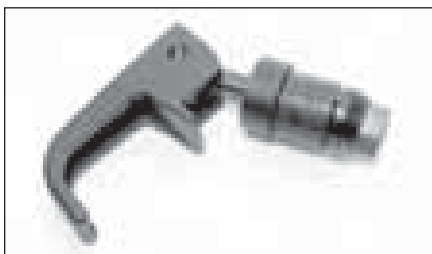

**J-Latch Assy Kit**

Order Part #: P-76-50055-03  
(Replaces Carrier #: 76-50055-03)

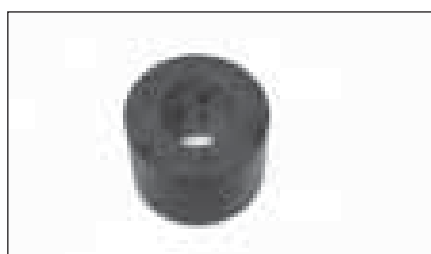

**Bushing, Latch**

Order Part #: P-44-01149-05  
(Replaces Carrier #: 44-01149-05)

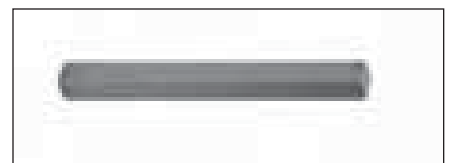

**Key (1/4" Square)**

Order Part #: P-34-01110-00  
(Replaces Carrier #: 34-01110-00)

## Truck & Trailer Parts – STRUCTURAL

STRUCTURAL

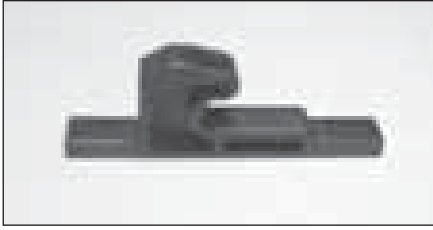

### Keeper, Latch

Order Part #: P-44-00340-03  
(Replaces Carrier #: 44-00340-03)

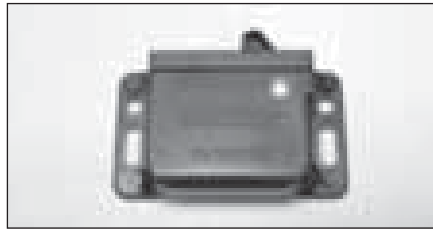

### Catch, Latch

Order Part #: P-44-00340-05  
(Replaces Carrier #: 44-00340-05)

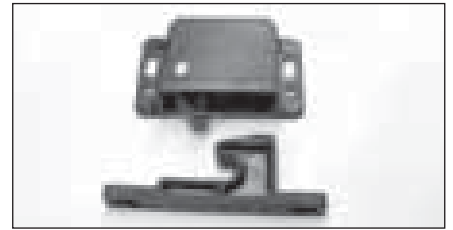

### Latch Kit

Order Part #: P-44-00340-04  
(Replaces Carrier #: 44-00340-04)

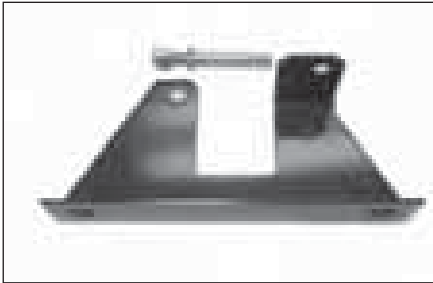

### Latch Pin Bracket Kit

Order Part #: P-68-07409-00SV  
(Replaces Carrier #: 68-07409-00SV)

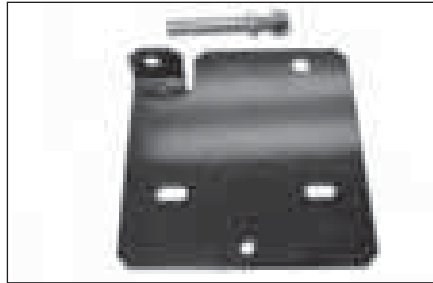

### Latch Pin Bracket Kit

Order Part #: P-68-07410-00SV  
(Replaces Carrier #: 68-07410-00SV)



### Nut, Jam (Brass)

Order Part #: P-34-00932-13  
(Replaces Carrier #: 34-00932-13)

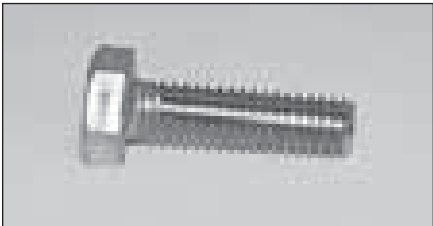

### Screw

Order Part #: P-34-01152-20  
(Replaces Carrier #: 34-01152-20)

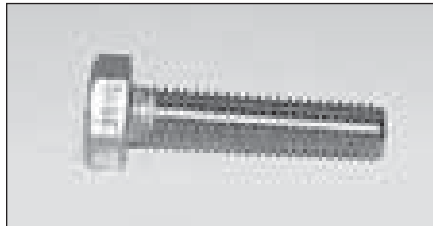

### Screw

Order Part #: P-34-01152-25  
(Replaces Carrier #: 34-01152-25)



### Screw, Mounting

Order Part #: P-44-01145-02  
(Replaces Carrier #: 44-01145-02)



### Screw, Thumb (Panel)

Order Part #: P-34-06127-00  
(Replaces Carrier #: 34-06127-00)

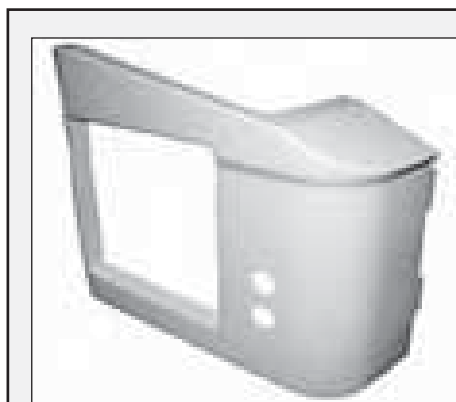

### Panel, RS (Supra)

Order Part #: P-58-60012-01  
(Replaces Carrier #: 58-60012-01)

# FIBERGLASS BODY PANELS FOR EXTRA, OPTIMA, ULTIMA & ULTRA UNITS

– PANELS ARE ALL WHITE, NO TRIM COLORS –

1. Door, Side Curbside  
Order Part #: P-58-01358-02W  
(Replaces Carrier #: 58-01358-02)

2. Door, Front Curbside  
Order Part #: P-58-01302-34W  
(Replaces Carrier #: 58-01302-34)

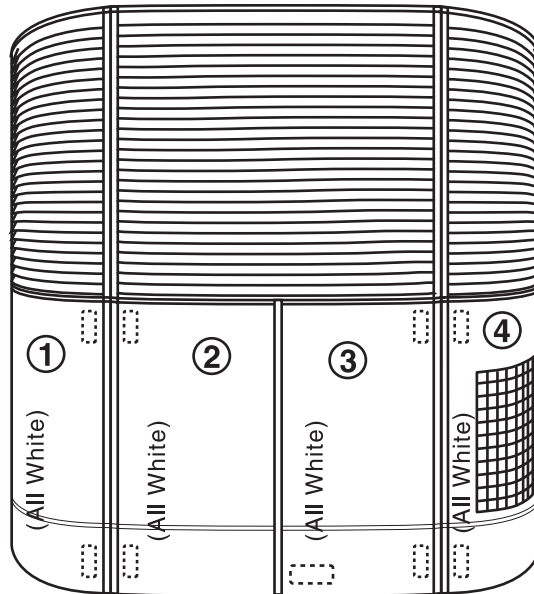

3. Door, Front Roadside  
Order Part #: P-58-01301-34W  
(Replaces Carrier #: 58-01301-34)

Door, Side Roadside  
4. Order Part #: P-58-01314-12W  
(Replaces Carrier #: 58-01314-12)

## ASK US ABOUT THESE AND OTHER GENUINE THERMO KING ACCESSORIES



Fuel Tanks



Anti Siphon Devices

## Truck & Trailer Parts – STRUCTURAL

STRUCTURAL

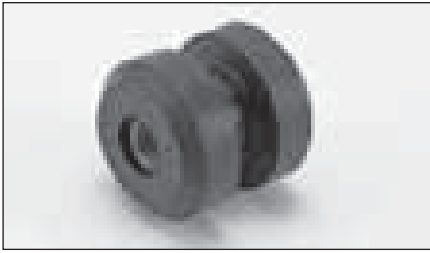

### Shockmount

Order Part #: P-73-00160-02  
(Replaces Carrier #: 73-00160-02)



### Shockmount

Order Part #: P-73-00154-03  
(Replaces Carrier #: 73-00154-03)

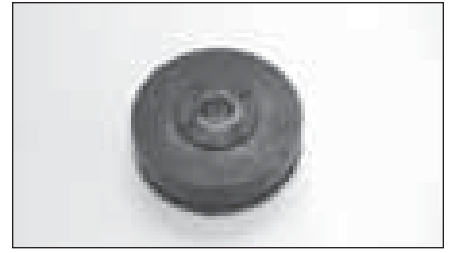

### Shockmount

Order Part #: P-73-00096-00  
(Replaces Carrier #: 73-00096-00)



### Strap, Adjusting

Order Part #: P-68-60041-01  
(Replaces Carrier #: 68-60041-01)



### Strap, Alternator

Order Part #: P-68-07438-03  
(Replaces Carrier #: 68-07438-03)

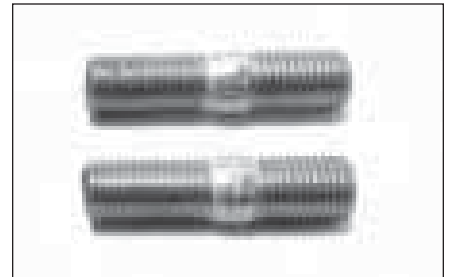

### Stud (Special)

Order Part #: P-34-00964-00  
(Replaces Carrier #: 34-00964-00)



### Tension Support Kit, Belt

Order Part #: P-79-02322-01  
(Replaces Carrier #: 79-02322-01)



### Washer

Order Part #: P-34-00890-00  
(Replaces Carrier #: 34-00890-00)

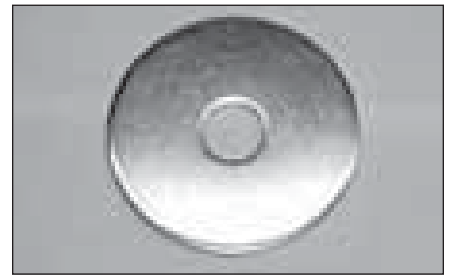

### Washer

Order Part #: P-34-00890-07  
(Replaces Carrier #: 34-00890-07)

**BUS COMPRESSORS**

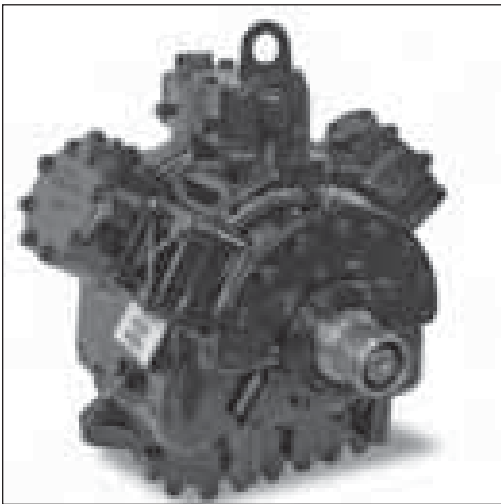

**We replace the following parts with new components:**

- |                  |                |
|------------------|----------------|
| ✓ Valve          | ✓ Valve plates |
| ✓ All gaskets    | ✓ Bearings     |
| ✓ Oil Pump       | ✓ Shaft seal   |
| ✓ Thrust Washers | ✓ Pistons      |
| ✓ Rods           | ✓ Crankshaft*  |

\* Replaced as new or remanufactured to OEM specification when necessary

**Compressor, Reman. (05G 37 CFM) Bus**

Order Part #: P-17-44065-00  
(Replaces Carrier #: 17-44065-00)

**Compressor, Reman. (05G 41 CFM) Bus**

Order Part #: P-17-44062-00  
(Replaces Carrier #: 17-44062-00)

**BUS CLUTCHES**



**Clutch Assembly 2B, 24V**

Order Part #: P-50-01122-07  
(Replaces Carrier #: 50-01122-07)



**Clutch Assembly 2C, 24V**

Order Part #: P-50-01122-01  
(Replaces Carrier #: 50-01122-01)

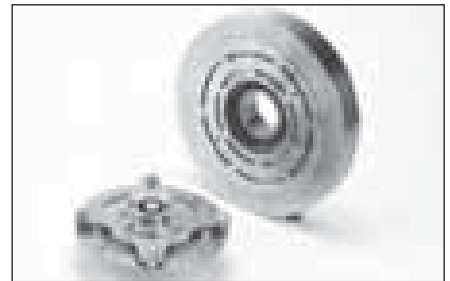

**Clutch Assembly**

Order Part #: P-50-01122-14  
(Replaces Carrier #: 50-01122-14)

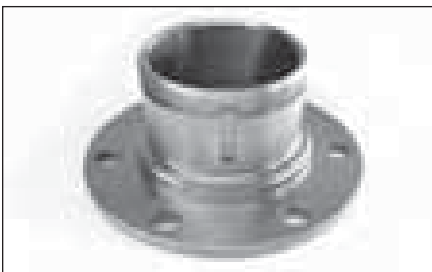

**Hub, Clutch**

Order Part #: P-17-44041-01  
(Replaces Carrier #: 17-44041-01)

**Thermo King remanufactures the Carrier® 05G bus compressors (37 and 41 CFM) to the same standard of excellence as all Thermo King compressors.**

- Crankshaft remanufactured or replaced to meet original OEM specifications
- Metal gaskets (versus fiber) for the heads and unloaders
- Oil pump replaced with a new pump
- Valve plates replaced with new valves to assure proper performance
- Connecting rods/pistons/rings replaced with new components
- All components are approved by Thermo King engineers
- Two year warranty from installation date

**BUS Parts – Mini-Bus/Transit/Coach**

**BUS FANS/BLOWERS/MOTORS**

*Fits Carrier OEM Fan  
(AC401-110) Only*

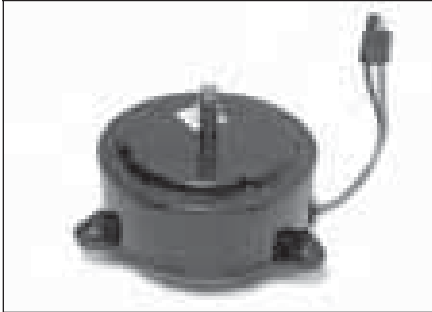

**Motor, Fan 12V**  
Order Part #: P-AC401-110-M  
(Replaces Carrier #: AC401-110-M)

*More Airflow, More Durable  
Than Carrier OEM!*

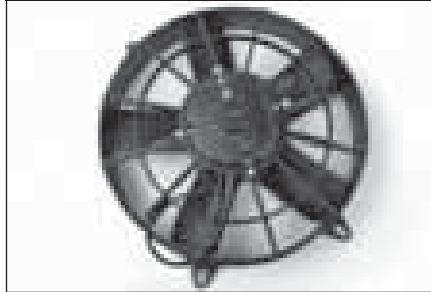

**Motor/Fan, Condenser 12V**  
Order Part #: P-AC401-110

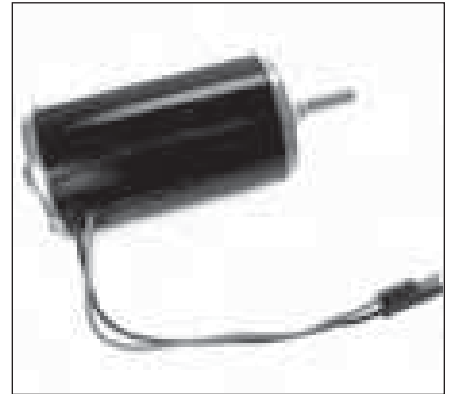

**Motor, 12V Condenser**  
Order Part #: P-AC501-102A  
(Replaces Carrier #: AC501-102A)

**BUS FILTERS**



**Drier, Filter**  
Order Part #: P-14-00320-00  
(Replaces Carrier #: 14-00320-00)

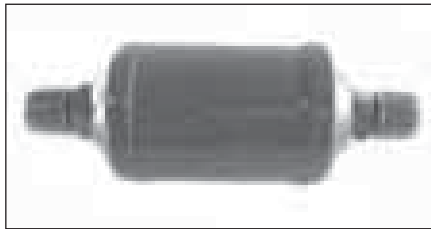

**Drier, Filter**  
Order Part #: P-AC101-312  
(Replaces Carrier #: AC101-312)



**Drier**  
Order Part #: P-14-00288-00  
(Replaces Carrier #: 14-00288-00)

**BUS GASKETS/O-RINGS**



**Gasket, Service Valve  
(Discharge) Fiber**  
Order Part #: P-17-44138-00  
(Replaces Carrier #: 17-44138-00)

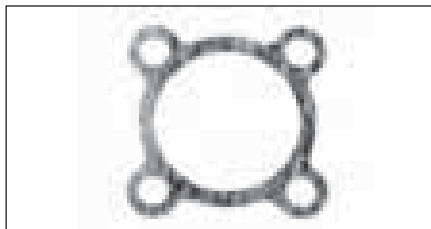

**Gasket, Service Valve  
(Suction)**  
Order Part #: P-17-40005-05  
(Replaces Carrier #: 17-40005-05)

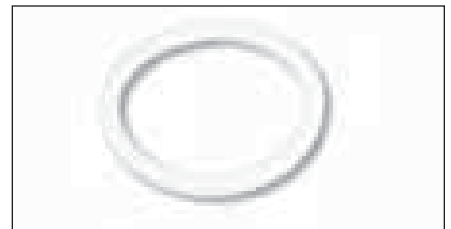

**Gasket, Sight Glass**  
Order Part #: P-17-10218-02  
(Replaces Carrier #: 17-10218-02)

**BUS SWITCHES/SENSORS**

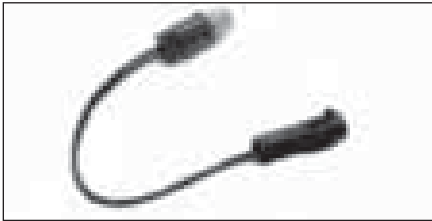

**Switch, Pressure**

Order Part #: P-12-00299-00  
(Replaces Carrier #: 12-00299-00)

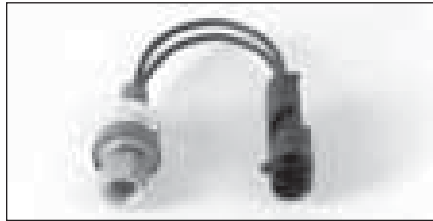

**Switch, Pressure**

Order Part #: P-12-00334-01  
(Replaces Carrier #: 12-00334-01)

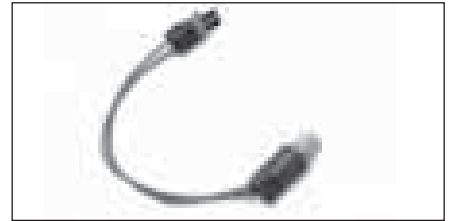

**Switch, Pressure (3-9)**

Order Part #: P-12-00299-01  
(Replaces Carrier #: 12-00299-01)



**Switch, Pressure #2, R22**

Order Part #: P-12-00334-00  
(Replaces Carrier #: 12-00334-00)

**BUS REFRIGERATION SYSTEM**



**Bearing, Shaft End  
(Unmachined)**

Order Part #: P-17-44015-00  
(Replaces Carrier #: 17-44015-00)



**Cap, Service Valve**

Order Part #: P-17-10812-00  
(Replaces Carrier #: 17-10812-00)

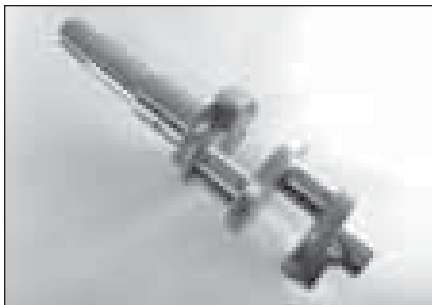

**Crankshaft (05G 37 CFM)  
(All Gear Pumps)**

Order Part #: P-17-40410-00  
(Replaces Carrier #: 17-40410-00)



**Crankshaft (05G 37 CFM)  
(Vane Pumps Only)**

Order Part #: P-17-44010-00  
(Replaces Carrier #: 17-44010-00)



**Crankshaft (05G 41CFM)  
(All Gear Pumps)**

Order Part #: P-17-40412-00  
(Replaces Carrier #: 17-40412-000)

## BUS Parts – Mini-Bus/Transit/Coach

### BUS REFRIGERATION PARTS (continued)



#### Indicator, Sightglass

Order Part #: P-14-00220-00  
(Replaces Carrier #: 14-00220-00)



#### Head, Cylinder (05G) HGBP Unloader

Order Part #: P-17-40104-05  
(Replaces Carrier #: 17-40104-05)



#### Plug Kit

Order Part #: P-17-55013-00  
(Replaces Carrier #: 17-55013-00)



#### Pump, Oil (Universal Gear)

Order Part #: P-17-44137-00  
(Replaces Carrier #: 17-44137-00)

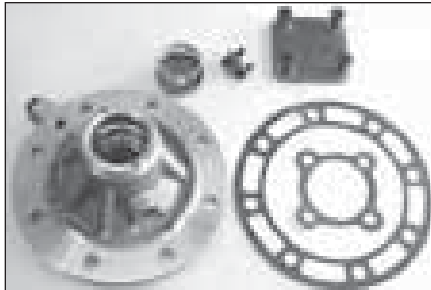

#### Pump, Oil (Vane)

Order Part #: P-17-40200-02  
(Replaces Carrier #: 17-40200-02)



#### Piston, Flat Top 41 CFM

Order Part #: P-17-44121-01  
(Replaces Carrier #: 17-44121-01)



#### Piston, Flat (Std) 37 CFM

Order Part #: P-17-44045-01  
(Replaces Carrier #: 17-44045-01)

#### Piston, Flat (+.020") 37 CFM

Order Part #: P-17-44045-03  
(Replaces Carrier #: 17-44045-03)

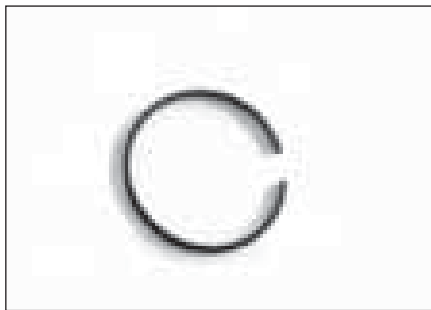

#### Ring, Piston (Std)

Order Part #: P-17-40055-00  
(Replaces Carrier #: 17-40055-00)

#### Ring, Piston (+.020")

Order Part #: P-17-55025-00  
(Replaces Carrier #: 17-55025-00)



#### Rod, Connecting (Std)

Order Part #: P-17-40056-02  
(Replaces Carrier #: 17-40056-02)

#### Rod, Connecting (+.010")

Order Part #: P-17-55023-00  
(Replaces Carrier #: 17-55023-00)

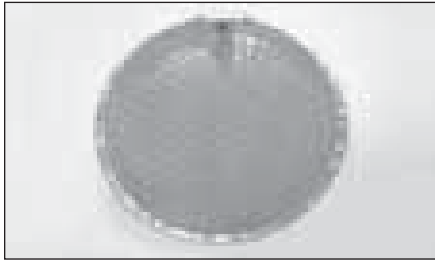

**Screen, Oil Filter (05G)**  
Order Part #: P-17-40020-00  
(Replaces Carrier #: 17-40020-00)

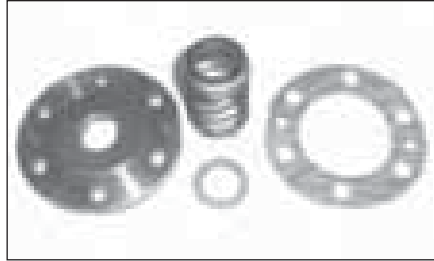

**Seal, Compressor (5F30 Bus)**  
Order Part #: P-17-10302-00  
(Replaces Carrier #: 17-10302-00)

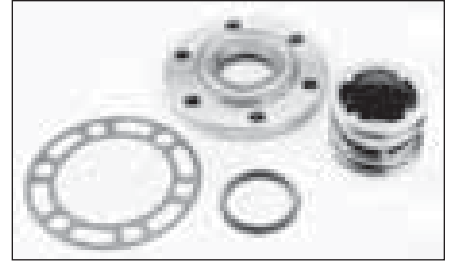

**Seal, Shaft (05G)**  
Order Part #: P-17-44145-00  
(Replaces Carrier #: 17-44145-00)

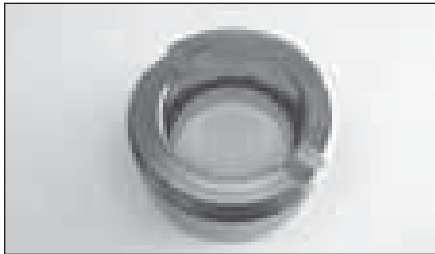

**Sightglass**  
Order Part #: P-17-10218-00  
(Replaces Carrier #: 17-10218-00)

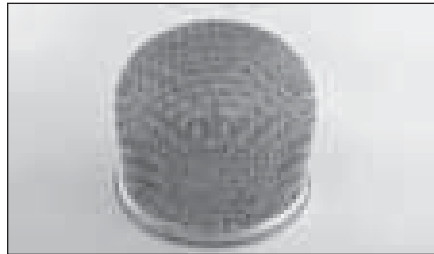

**Strainer, Suction (05G)**  
Order Part #: P-17-44005-00  
(Replaces Carrier #: 17-44005-00)

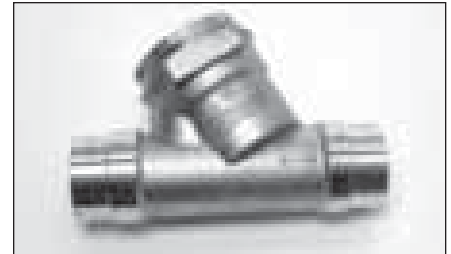

**Valve, Check**  
Order Part #: P-14-00029-07  
(Replaces Carrier #: 14-00029-07)

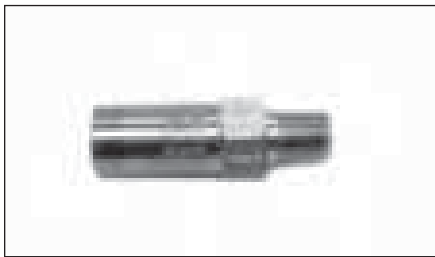

**Valve, Relief (450 psig)**  
Order Part #: P-EB-51RP-061  
(Replaces Carrier #: EB-51RP-061)

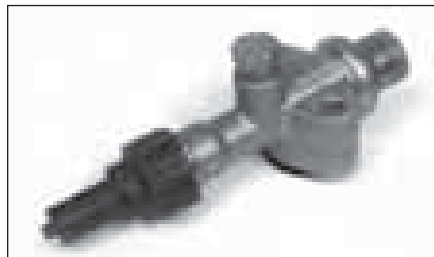

**Valve, Service 7/8**  
Order Part #: P-14-01042-04  
(Replaces Carrier #: 14-01042-04)

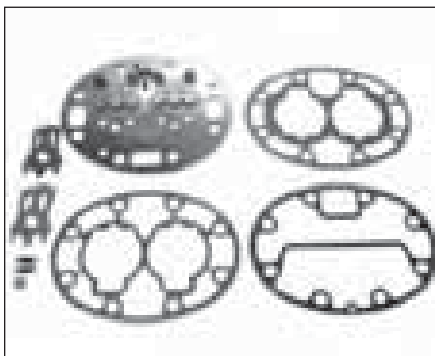

**Valve Plate (Flat, Side Bank w/HGBP)**  
Order Part #: P-17-44106-00  
(Replaces Carrier #: 17-44106-00)

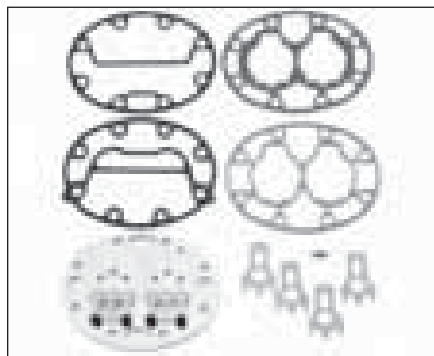

**Valve Plate (Flat, Ctr or Side w/Suc.cutoff)**  
Order Part #: P-17-44107-00  
(Replaces Carrier #: 17-44107-00)

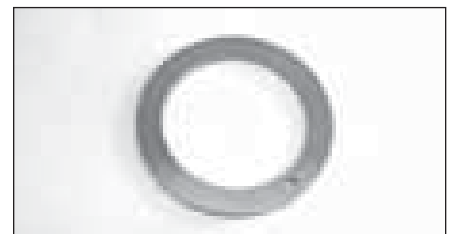

**Washer, Thrust (Seal End)**  
Order Part #: P-17-44008-00  
(Replaces Carrier #: 17-44008-00)

**CONTAINER COMPRESSOR PARTS**

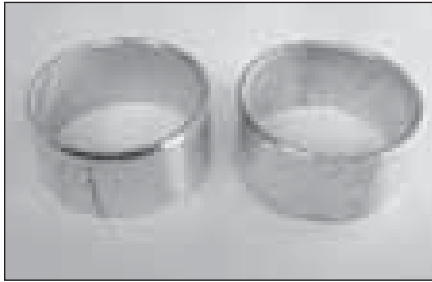

**Bearing, Shaft End  
(Unmachined)**

Order Part #: P-17-44015-00  
(Replaces Carrier #: 17-44015-00)

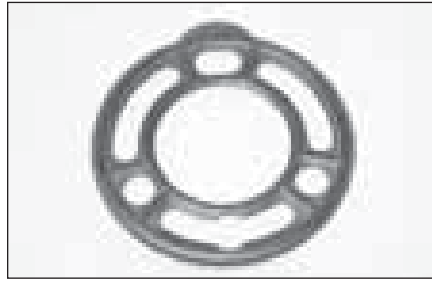

**Gasket, Unloader**

Order Part #: P-17-40104-07  
(Replaces Carrier #: 17-40104-07)

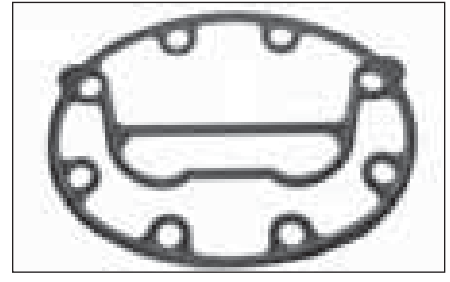

**Gasket, Suction Cutout  
Unloader Head**

Order Part #: P-17-44125-00  
(Replaces Carrier #: 17-44125-00)

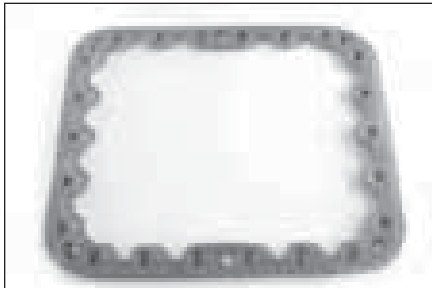

**Gasket, Bottom Plate**

Order Part #: P-17-40033-05  
(Replaces Carrier #: 17-40033-05)

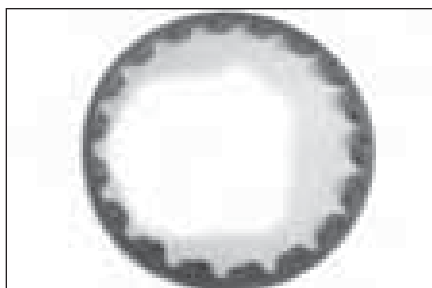

**Gasket, Cover**

Order Part #: P-17-40029-05  
(Replaces Carrier #: 17-40029-05)



**Gasket, Cover**

Order Part #: P-17-40075-05  
(Replaces Carrier #: 17-40075-05)

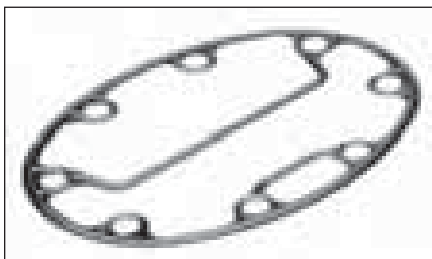

**Gasket, Head Center**

Order Part #: P-17-44123-00  
(Replaces Carrier #: 17-44123-00)

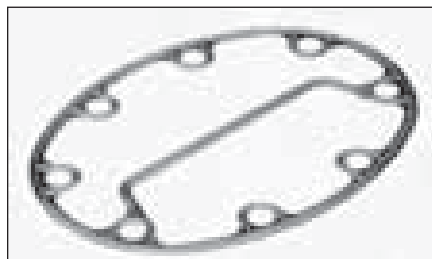

**Gasket, Head w/o Unloaders**

Order Part #: P-17-44124-00  
(Replaces Carrier #: 17-44124-00)

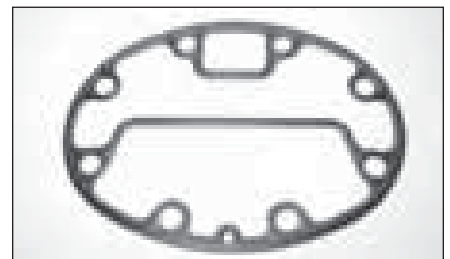

**Gasket, Head**

Order Part #: P-17-44126-00  
(Replaces Carrier #: 17-44126-00)

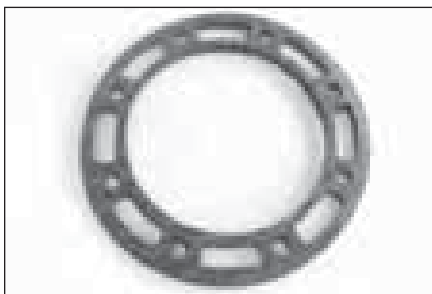

**Gasket, Pump End**

Order Part #: P-17-40078-05  
(Replaces Carrier #: 17-40078-05)

## CONTAINER Parts

### CONTAINER COMPRESSOR PARTS (continued)

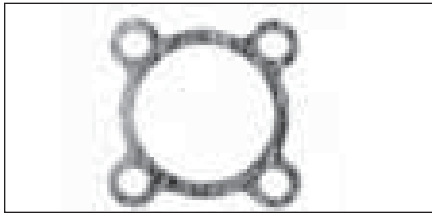

#### Gasket, Service Valve (Suction)

Part #: P-17-40005-05  
(Replaces Carrier #: 17-40005-05)

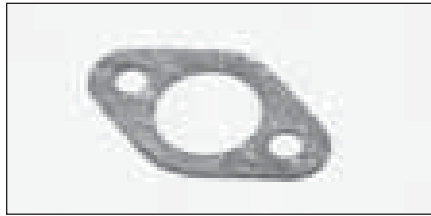

#### Gasket, Service Valve (Discharge) Fiber

Order Part #: P-17-44138-00  
(Replaces Carrier #: 17-44138-00)

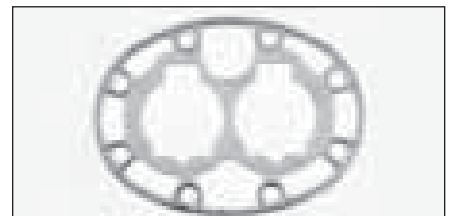

#### Gasket, Valve Plate

Order Part #: P-17-44007-06  
(Replaces Carrier #: 17-44007-06)

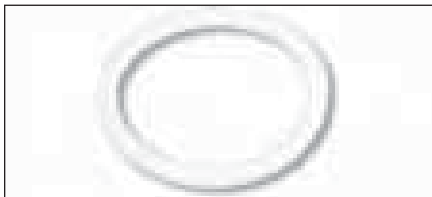

#### Gasket, Sight Glass

Order Part #: P-17-10218-02  
(Replaces Carrier #: 17-10218-02)

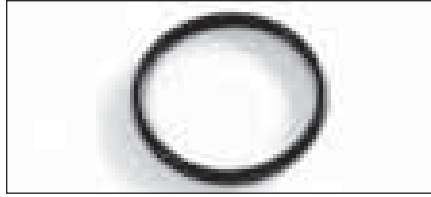

#### O-Ring

Order Part #: P-17-55022-00  
(Replaces Carrier #: 17-55022-00)

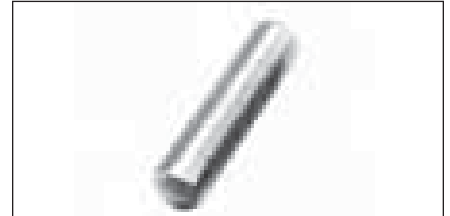

#### Pin Dowel

Order Part #: P-17-40057-00  
(Replaces Carrier #: 17-40057-00)



#### Piston, Contour Head (Std) 37 CFM

Order Part #: P-17-44016-05  
(Replaces Carrier #: 17-44016-05)

#### Piston, Contour Head (+.020")

Order Part #: P-17-44016-07  
(Replaces Carrier #: 17-44016-07)



#### Piston, 2 Ring, Cont Head (Std) 41 CFM

Order Part #: P-17-44115-01  
(Replaces Carrier #: 17-44115-01)

#### Piston, 2 Ring, Cont Head (+.020")

Order Part #: P-17-44115-20  
(Replaces Carrier #: 17-44115-20)



#### Ring, Piston

Order Part #: P-17-40055-00  
(Replaces Carrier #: 17-40055-00)

#### Ring, Piston (+.020")

Order Part #: P-17-55025-00  
(Replaces Carrier #: 17-55025-00)

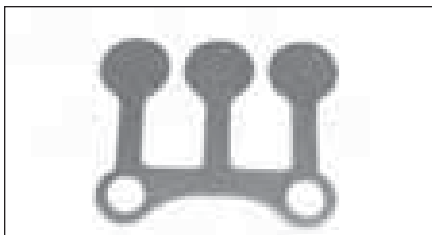

#### Reed, Discharge (Hi Eff)

Order Part #: P-06DA502-913  
(Replaces Carrier #: 06DA502-913)



#### Reed, Suction (Hi Eff)

Order Part #: P-06DA502-903  
(Replaces Carrier #: 06DA502-903)

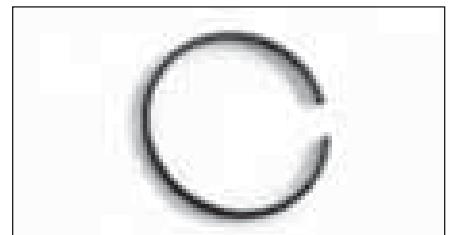

#### Ring, Oil (only for older 37cfm pistons w/wider lower groove)

Order Part #: P-17-40054-00  
(Replaces Carrier #: 17-40054-00)



**Pump, Oil (Universal Gear)**  
 Order Part #: P-17-44137-00  
 (Replaces Carrier #: 17-44137-00)

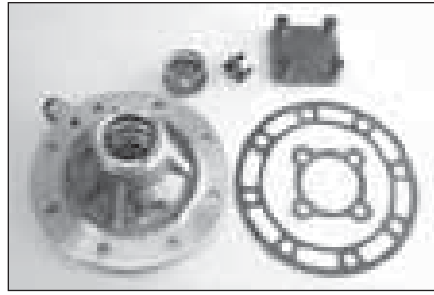

**Pump, Oil (Vane)**  
 Order Part #: P-17-40200-02  
 (Replaces Carrier #: 17-40200-02)



**Rod, Connecting (Std)**  
 Order Part #: P-17-40056-02  
 (Replaces Carrier #: 17-40056-02)

**Rod, Connecting (+.010")**  
 Order Part #: P-17-55023-00  
 (Replaces Carrier #: 17-55023-00)

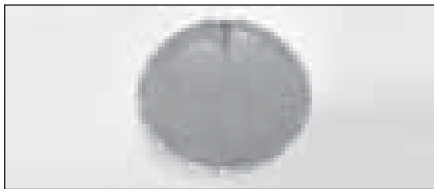

**Screen, Oil Filter**  
 Order Part #: P-17-40020-00  
 (Replaces Carrier #: 17-40020-00)



**Sightglass**  
 Order Part #: P-17-10218-00  
 (Replaces Carrier #: 17-10218-00)

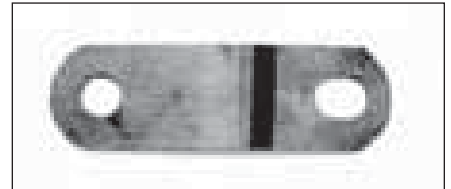

**Spring, Suction Valve**  
 Order Part #: P-17-40083-00  
 (Replaces Carrier #: 17-40083-00)



**Strainer, Suction (05G)**  
 Order Part #: P-17-44005-00  
 (Replaces Carrier #: 17-44005-00)

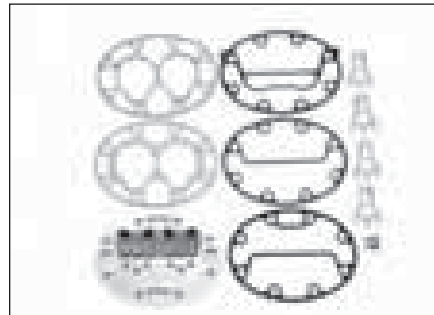

**Valve Plate (Canted, Center or Side Bank)**  
 Order Part #: P-17-44105-00  
 (Replaces Carrier #: 17-44105-00)



**Valve Plate (Canted, Side Bank w/HGBP)**  
 Order Part #: P-17-44104-00  
 (Replaces Carrier #: 17-44104-00)

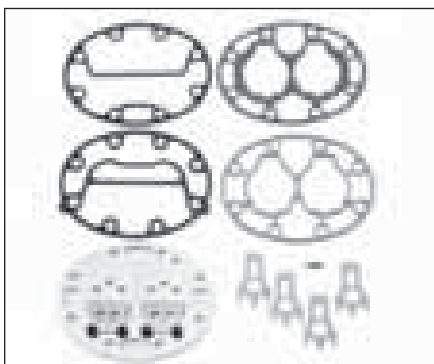

**Valve Plate (Flat, Ctr or Side w/Suc. cutoff)**  
 Order Part #: P-17-44107-00  
 (Replaces Carrier #: 17-44107-00)

## CONTAINER Parts

### CONTAINER COMPRESSOR PARTS (continued)

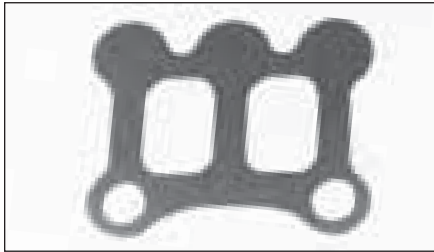

#### Valve, Discharge

Order Part #: P-17-40086-00  
(Replaces Carrier #: 17-40086-00)

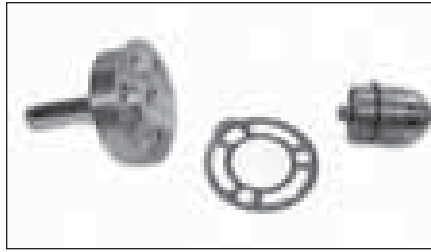

#### Valve, Unloader

Order Part #: P-17-40417-00  
(Replaces Carrier #: 17-40417-00)



#### Valve, Suction (05G)

Order Part #: P-17-44111-00  
(Replaces Carrier #: 17-44111-00)

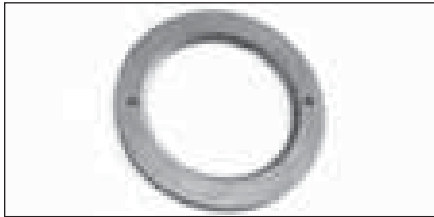

#### Washer, Thrust (Pump End)

Order Part #: P-17-55009-01  
(Replaces Carrier #: 17-55009-01)

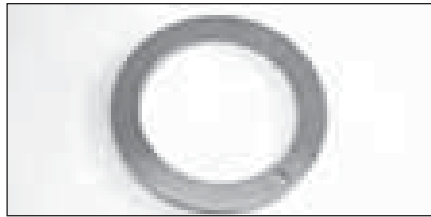

#### Washer, Thrust (Seal End)

Order Part #: P-17-44008-00  
(Replaces Carrier #: 17-44008-00)

### CONTAINER ENGINE PARTS

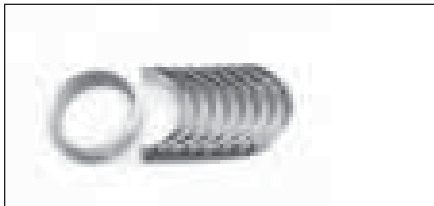

#### Bearing Set, Main #1-#5 (-0.2MM)

Order Part #: P-25-38126-01-B  
(Replaces Carrier #: 25-38126-01)

#### Bearing Set, Main #1-#5 (-0.4MM)

Order Part #: P-25-38126-02-B  
(Replaces Carrier #: 25-38126-02)



#### Bearing, Main #1(Std)

Order Part #: P-25-39120-00-B  
(Replaces Carrier #: 25-39120-00)

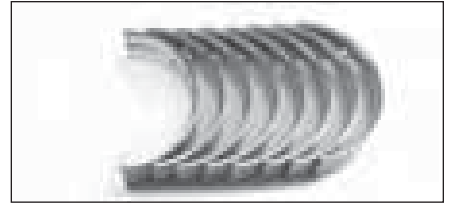

#### Bearing, Main #2-#5 (Std)

Order Part #: P-25-39121-00-B  
(Replaces Carrier #: 25-39121-00)



#### Bearing, Rod (Std)

Order Part #: P-25-39122-00-B  
(Replaces Carrier #: 25-39122-00)

#### Bearing, Rod (-0.2MM)

Order Part #: P-25-38122-01-B  
(Replaces Carrier #: 25-38122-01)

#### Bearing, Rod (-0.4MM)

Order Part #: P-25-38122-02-B  
(Replaces Carrier #: 25-38122-02)

**CONTAINER ENGINE PARTS (continued)**

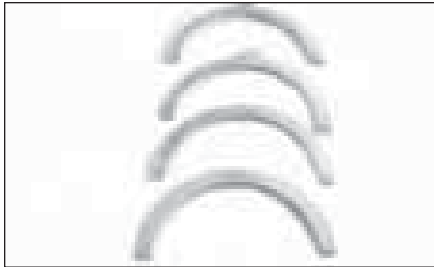

**Bearing, Thrust (Std)**  
 Order Part #: P-25-37399-00-B  
 (Replaces Carrier #: 25-37399-00)



**Bushing, Piston Pin**  
 Order Part #: P-25-38121-00-B  
 (Replaces Carrier #: 25-38121-00)



**Dipstick**  
 Order Part #: P-25-37085-00  
 (Replaces Carrier #: 25-37085-00)

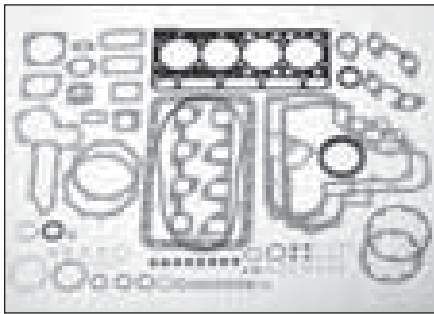

**Gasket Set (133 & 134DI)**  
 Order Part #: P-25-38513-00  
 (Replaces Carrier #: 25-38513-00)

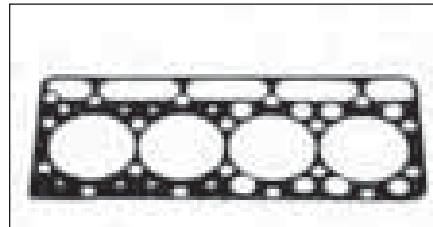

**Gasket, Head (134DI)**  
 Order Part #: P-25-38529-01-B  
 (Replaces Carrier #: 25-38529-01)

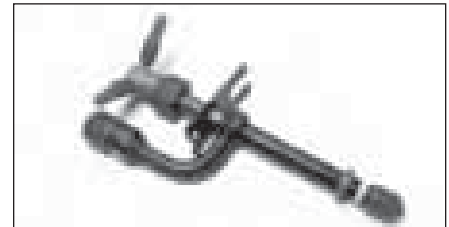

**Injector, Fuel**  
 Order Part #: P-25-38640-00  
 (Replaces Carrier #: 25-38640-00)



**Piston Assy w/o Rings (Std) (134DI)**  
 Order Part #: P-25-39127-01-B  
 (Replaces Carrier #: 25-39127-01)

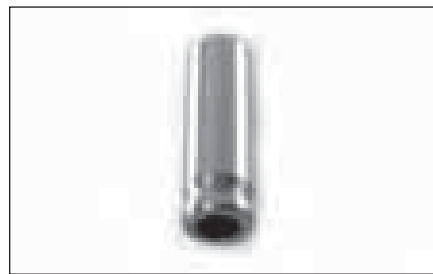

**Guide, Exhaust Valve**  
 Order Part #: P-25-39037-00-B  
 (Replaces Carrier #: 25-39037-00)



**Guide, Intake Valve**  
 Order Part #: P-25-39036-00  
 (Replaces Carrier #: 25-39036-00)

**Piston Assy w/o Rings (+0.5MM) (134DI)**  
 Order Part #: P-25-39128-01-B  
 (Replaces Carrier #: 25-39128-01)

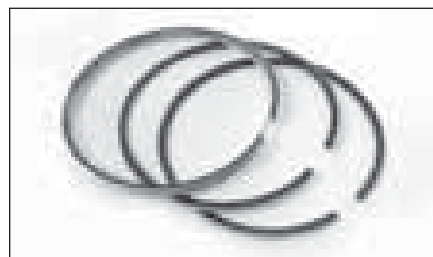

**Ring Set, Piston (Std)**  
 Order Part #: P-25-38611-00  
 (Replaces Carrier #: 25-38611-00)  
**Ring Set, Piston (+ 0.5MM)**  
 Order Part #: P-25-38611-01-B  
 (Replaces Carrier #: 25-38611-01-B)

**CONTAINER**

## CONTAINER Parts

### CONTAINER ENGINE PARTS (continued)



#### Plug, Expansion

Order Part #: P-25-37107-00  
(Replaces Carrier #: 25-37107-00)

#### Plug, Expansion

Order Part #: P-25-37032-00  
(Replaces Carrier #: 25-37032-00)

#### Plug, Expansion

Order Part #: P-25-37033-00  
(Replaces Carrier #: 25-37033-00)



#### Plug Set, Expansion (Block)

Order Part #: P-25-37020-00  
(Replaces Carrier #: 25-37020-00)

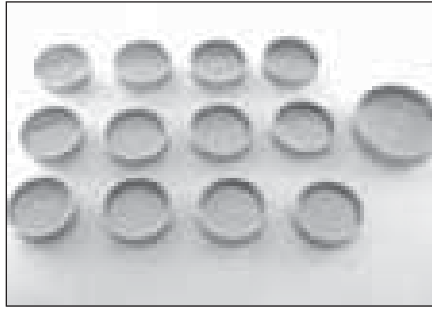

#### Plug Set, Expansion (Head)

Order Part #: P-25-37021-00  
(Replaces Carrier #: 25-37021-00)



#### Plug, Glow

Order Part #: P-25-38150-01  
(Replaces Carrier #: 25-38150-01)

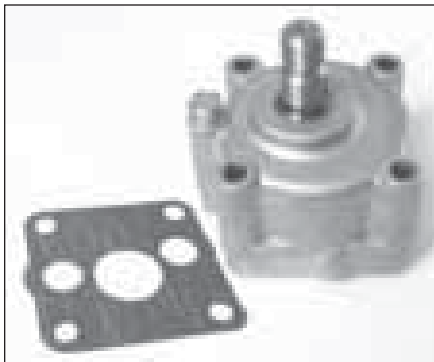

#### Pump, Oil (w/gasket)

Order Part #: P-25-37040-00  
(Replaces Carrier #: 25-37040-00)

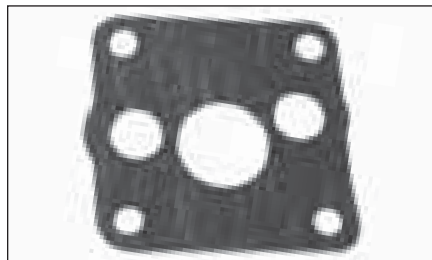

#### Gasket, Oil Pump (CT4 engines, except 91)

Order Part #: P-25-37041-00  
(Replaces Carrier #: 25-37041-00)



#### Pump, Fuel Assembly

Order Part #: P-25-38666-00  
(Replaces Carrier #: 25-38666-00)

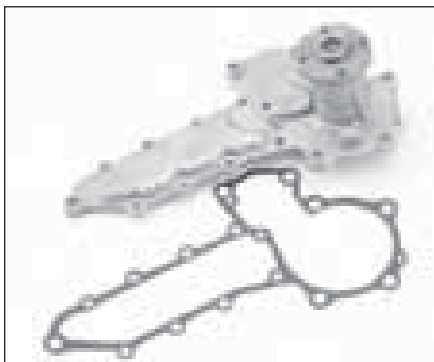

#### Pump, Water

Order Part #: P-25-37581-10-B  
(Replaces Carrier #: 25-37581-10)



#### Pump, Priming

Order Part #: P-25-38666-11  
(Replaces Carrier #: 25-38666-11)

## CONTAINER Parts

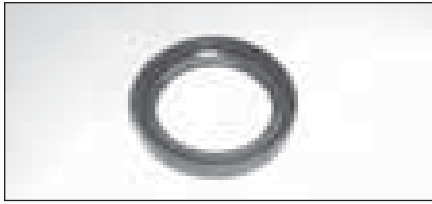

### Seal, Oil (Front)

Order Part #: P-25-37396-01-B  
(Replaces Carrier #: 25-37396-01)

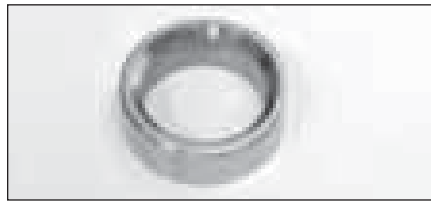

### Sleeve, Wear (Front)

Order Part #: P-25-37388-00-B  
(Replaces Carrier #: 25-37388-00)



### Sleeve, Wear (Rear)

Order Part #: P-25-37385-02-B  
(Replaces Carrier #: 25-37382-02)



### Thermostat, Water w/Gasket

Order Part #: P-25-37559-01  
(Replaces Carrier #: 25-37559-01)

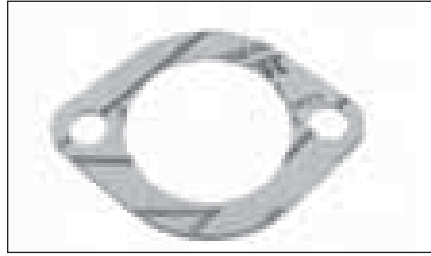

### Gasket, Thermostat

Order Part #: P-25-37558-00  
(Replaces Carrier #: 25-37558-00)



### Tube, Water Return

Order Part #: P-25-37556-00  
(Replaces Carrier #: 25-37556-00)

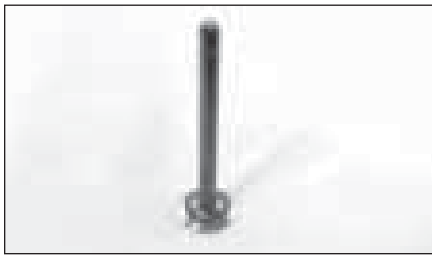

### Valve, Exhaust

Order Part #: P-25-38086-00-B  
(Replaces Carrier #: 25-38086-00)

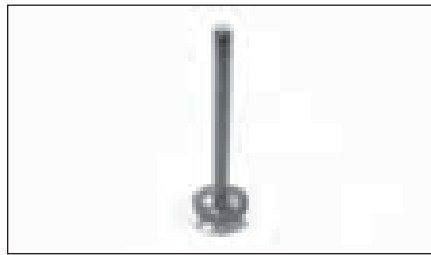

### Valve, Intake

Order Part #: P-25-38085-00-B  
(Replaces Carrier #: 25-38085-00)

## CONTAINER GENERAL PARTS

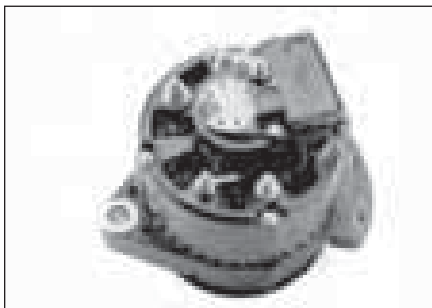

### Alternator (65A)

Order Part #: P-30-00423-00  
(Replaces Carrier #: 30-00423-00)

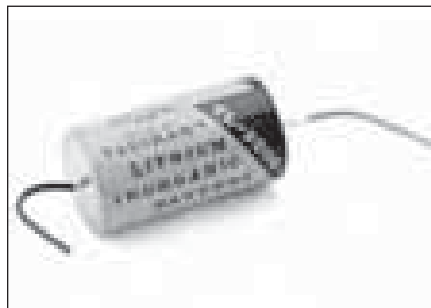

### Battery, Lithium (3.6V)

Order Part #: P-12-01084-07  
(Replaces Carrier #: 12-01084-07)

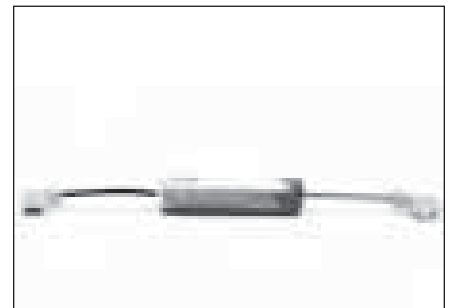

### Battery, Lithium (3.6V)

Order Part #: P-22-50051-00  
(Replaces Carrier #: 22-50051-00)

## CONTAINER Parts

### CONTAINER GENERAL PARTS (continued)

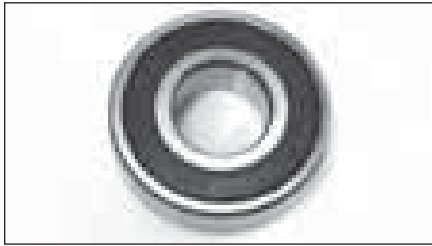

#### Bearing, Idler

Order Part #: P-04-00018-00  
(Replaces Carrier #: 04-00018-00)

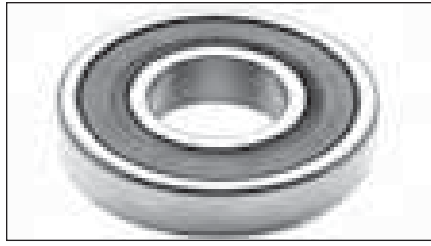

#### Bearing, Alternator, Front

Order Part #: P-30-00423-28  
(Replaces Carrier #: 30-00423-28)

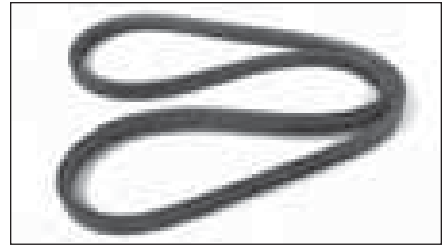

#### Belt, Alternator

Order Part #: P-50-00204-01  
(Replaces Carrier #: 50-00204-01)

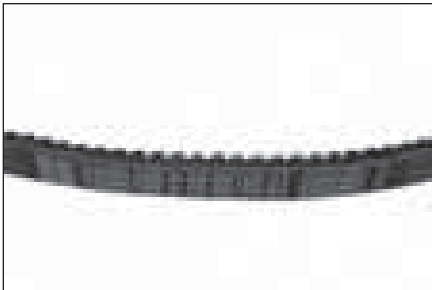

#### Belt, Water Pump

Order Part #: P-50-00162-04  
(Replaces Carrier #: 50-00162-04)

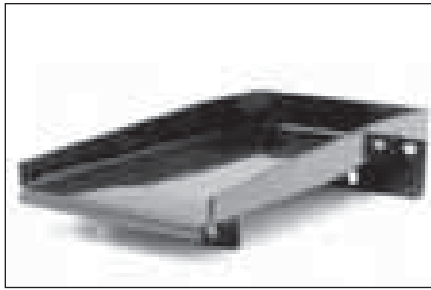

#### Box, Battery

Order Part #: P-86-04106-00  
(Replaces Carrier #: 86-04106-00)

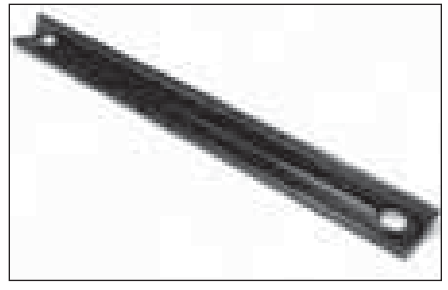

#### Bracket, Battery Hold Down

Order Part #: P-68-13945-00  
(Replaces Carrier #: 68-13945-00)



#### Breaker, Circuit

Order Part #: P-66U1-7842-13  
(Replaces Carrier #: 66U1-7842-13)



#### Breaker, Circuit (48A, 230V)

Order Part #: P-66U1-7842-2  
(Replaces Carrier #: 66U1-7842-2)

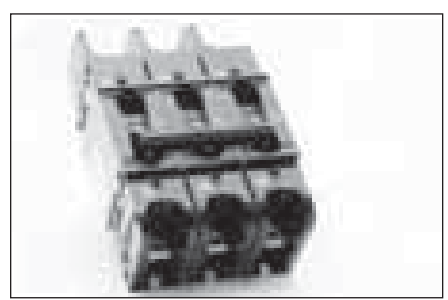

#### Breaker, Circuit (CB1)

Order Part #: P-66U1-1723-3  
(Replaces Carrier #: 66U1-1723-3)

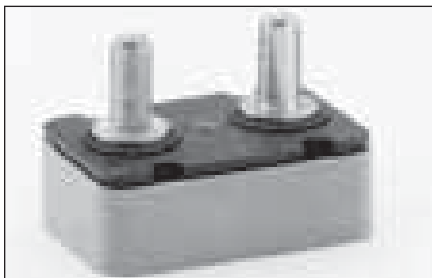

#### Breaker, Circuit (CB2, 30A, 12V)

Order Part #: P-10-00171-12  
(Replaces Carrier #: 10-00171-12)



#### Breaker, Circuit (CB2)

Order Part #: P-10-00277-00  
(Replaces Carrier #: 10-00277-00)

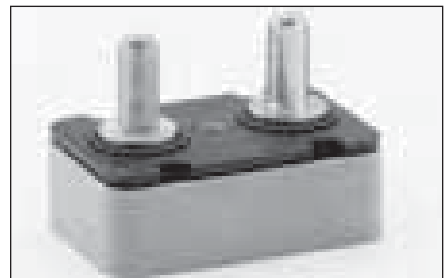

#### Breaker, Circuit (CB3, 50A, 12V)

Order Part #: P-10-00171-13  
(Replaces Carrier #: 10-00171-13)

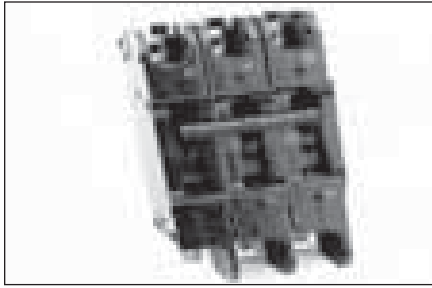

**Breaker, Circuit  
(Comp., 460V)**

Order Part #: P-66U1-1723-2  
(Replaces Carrier #: 66U1-1723-2)

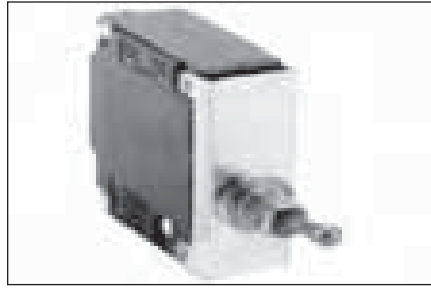

**Breaker, Circuit  
(Start/Stop)**

Order Part #: P-66U1-3683  
(Replaces Carrier #: 66U1-3683)



**Breaker, Circuit**

Order Part #: P-66U1-7842-5  
(Replaces Carrier #: 66U1-7842-5)



**Breaker, Current  
(On/Off, 12A)**

Order Part #: P-10-00360-01  
(Replaces Carrier #: 10-00360-01)

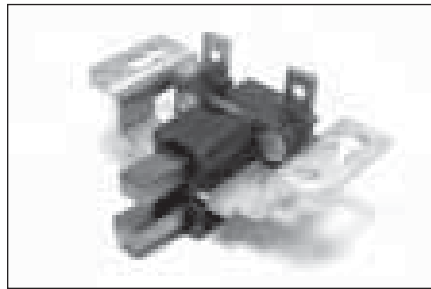

**Brush Assembly, Alternator**

Order Part #: P-30-00409-30  
(Replaces Carrier #: 30-00409-30)



**Cap, Coupling**

Order Part #: P-40-00520-02  
(Replaces Carrier #: 40-00520-02)



**Cap, Coupling**

Order Part #: P-40-00520-03  
(Replaces Carrier #: 40-00520-03)



**Cap, Radiator**

Order Part #: P-30-00397-00  
(Replaces Carrier #: 30-00397-00)



**Cap, Service Valve**

Order Part #: P-17-10812-00  
(Replaces Carrier #: 17-10812-00)



**Catch, Latch**

Order Part #: P-44-00340-05  
(Replaces Carrier #: 44-00340-05)

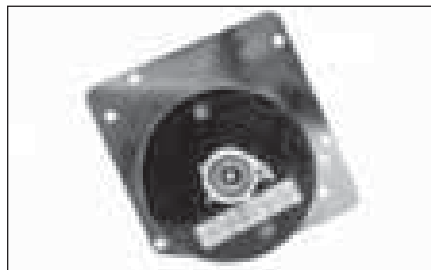

**Clock, 31 Day (CCW)**

Order Part #: P-09-00123-00  
(Replaces Carrier #: 09-00123-00)

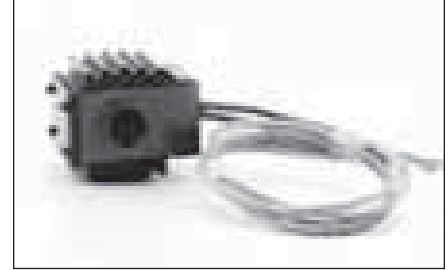

**Coil, Solenoid (24VAC)**

Order Part #: P-14-01091-01  
(Replaces Carrier #: 14-01091-01)

## CONTAINER Parts

### CONTAINER GENERAL PARTS (continued)

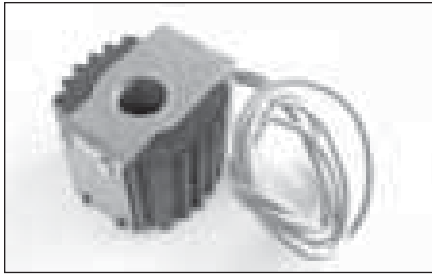

**Coil, Solenoid (24VDC)**  
Order Part #: P-14-01091-02  
(Replaces Carrier #: 14-01091-02)



**Coil, Condenser (Copper/Copper)**  
Order Part #: P-69NT43-202-10SV  
(Replaces Carrier #: 69NT43-202-10SV)



**Coil, Condenser (Copper/Aluminum)**  
Order Part #: P-69NT43-202-20SV  
(Replaces Carrier #: 69NT43-202-20SV)



**Coil, Solenoid Valve**  
Order Part #: P-14-50021-02  
(Replaces Carrier #: 14-50021-02)

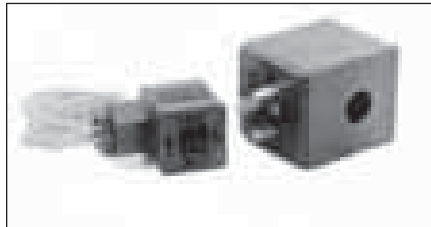

**Coil, Solenoid**  
Order Part #: P-14-00230-24SV  
(Replaces Carrier #: 14-00230-24SV)

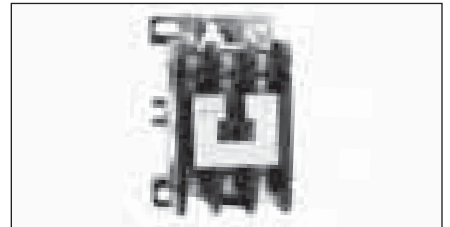

**Contactor W/Aux (40A)**  
Order Part #: P-10-00304-33SV  
(Replaces Carrier #: 10-00304-33SV)

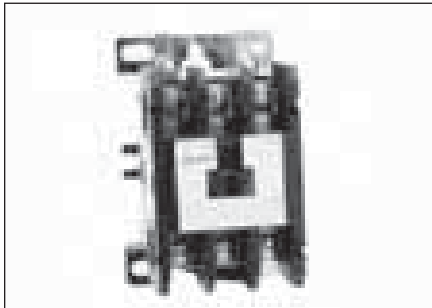

**Contactor, Compressor (40A)**  
Order Part #: P-10-00304-33  
(Replaces Carrier #: 10-00304-33)

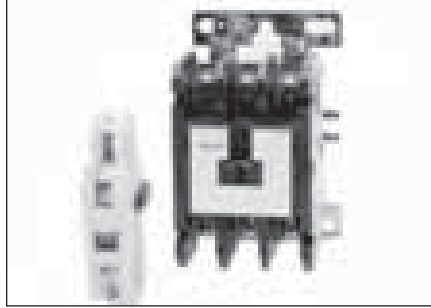

**Contactor, Fan, W/Aux (15A)**  
Order Part #: P-10-00304-32SV  
(Replaces Carrier #: 10-00304-32SV)



**Coupling, Hi**  
Order Part #: P-40-00520-01  
(Replaces Carrier #: 40-00520-01)



**Drier, Filter (Single)**  
Order Part #: P-14-00284-02SV  
(Replaces Carrier #: 14-00284-02SV)



**Coupling, Lo**  
Order Part #: P-40-00520-00  
(Replaces Carrier #: 40-00520-00)

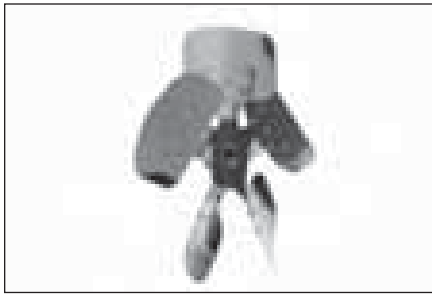

**Fan, Cond., 16" Propeller**  
Order Part #: P-38-00511-00SV  
(Replaces Carrier #: 38-00511-00SV)

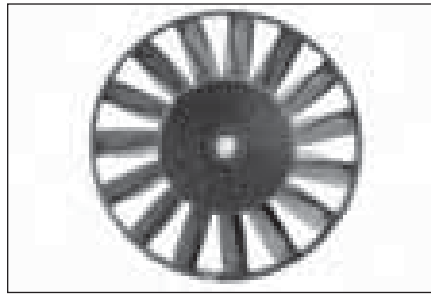

**Fan, Cond., 17.5" (Composite)**  
Order Part #: P-38-00503-00  
(Replaces Carrier #: 38-00503-00)



**Fuse, Blade (2A)**  
Order Part #: 41-2543  
(Replaces Carrier #: 22-02336-07)

**Fuse, Blade (3A)**  
Order Part #: 44-9524  
(Replaces Carrier #: 22-02336-03)

**Fuse, Blade (5A)**  
Order Part #: P-22-02336-02  
(Replaces Carrier #: 22-02336-02)

**Fuse, Blade (10A)**  
Order Part #: P-22-02336-04  
(Replaces Carrier #: 22-02336-04)

**Fuse, Blade (15A)**  
Order Part #: P-22-02336-06  
(Replaces Carrier #: 22-02336-06)

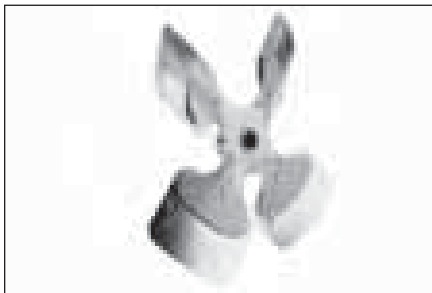

**Fan, Evap, 13" Prop, LH**  
Order Part #: P-38-00126-00  
(Replaces Carrier #: 38-00126-00)

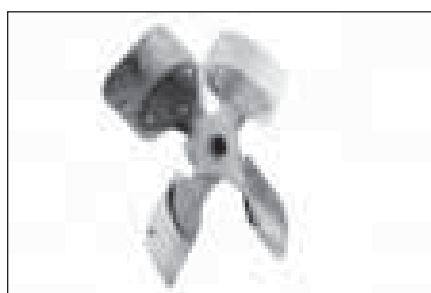

**Fan, Evap, 13" Prop, RH**  
Order Part #: P-38-00125-00  
(Replaces Carrier #: 38-00125-00)



**Filter, Oil**  
Order Part #: P-30-00323-00  
(Replaces Carrier #: 30-00323-00)



**Drain Cock**  
Order Part #: P-25-37593-00  
(Replaces Carrier #: 25-37593-00)

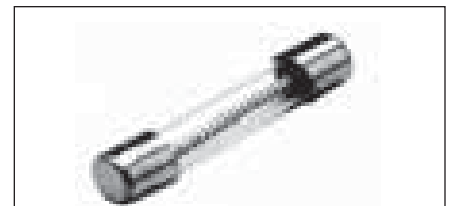

**Fuse, Glass, Slow Blow (1A)**  
Order Part #: P-22-00060-22  
(Replaces Carrier #: 22-00060-22)

**Fuse, Glass, Slow Blow (3A)**  
Order Part #: P-HY-10FJ-203  
(Replaces Carrier #: HY-10FJ-203)

**Fuse, Glass, 1" (3A)**  
Order Part #: P-22-00060-20  
(Replaces Carrier #: 22-00060-20)

**Fuse, Glass, Slow Blow (5A)**  
Order Part #: P-22-00060-21  
(Replaces Carrier #: 22-00060-21)

**Fuse, Glass, Slow Blow (6A)**  
Order Part #: P-22-60288-10  
(Replaces Carrier #: 22-60288-10)

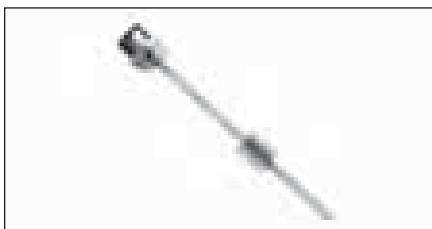

**Gauge, Fuel**  
Order Part #: P-12-01098-04  
(Replaces Carrier #: 12-01098-04)

## CONTAINER Parts

### CONTAINER GENERAL PARTS (continued)



#### Gauge, Oil Pressure

Order Part #: P-66U1-2823  
(Replaces Carrier #: 66U1-2823)

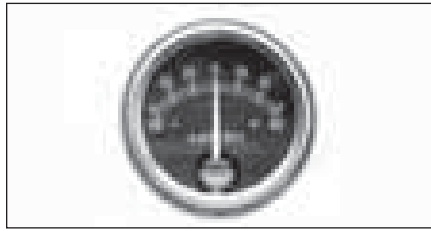

#### Gauge, Ammeter (+60A/-60A)

Order Part #: P-22-00538-01SV  
(Replaces Carrier #: 22-00538-01SV)



#### Gauge, Water Temp

Order Part #: P-12-00097-03  
(Replaces Carrier #: 12-00097-03)

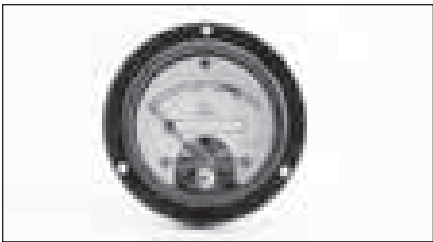

#### Gauge, Voltmeter

Order Part #: P-22-00462-00  
(Replaces Carrier #: 22-00462-00)

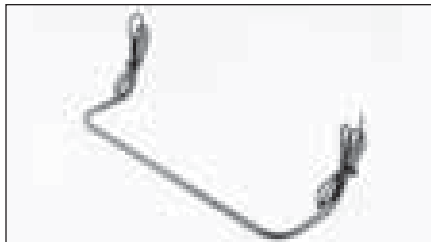

#### Heater, Drain Pan, 19" (49CM)

Order Part #: P-24-00002-00  
(Replaces Carrier #: 24-00002-00)



#### Heater, Drain Pan, 24" (61CM)

Order Part #: P-24-00003-00  
(Replaces Carrier #: 24-00003-00)

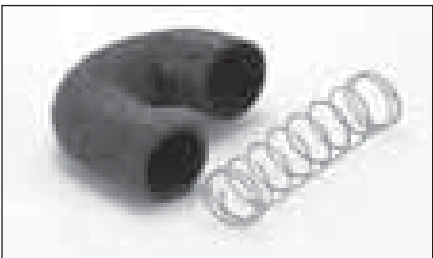

#### Hose, Formed (AIR)

Order Part #: P-58-00976-00  
(Replaces Carrier #: 58-00976-00)



#### Hose, Formed (AIR)

Order Part #: P-58-04203-01  
(Replaces Carrier #: 58-04203-01)



#### Hose, Formed (Eng to Rad)

Order Part #: P-58-04216-00  
(Replaces Carrier #: 58-04216-00)



#### Hose, Formed (Rad to WP)

Order Part #: P-58-04215-00  
(Replaces Carrier #: 58-04215-00)



#### Indicator, Moisture

Order Part #: P-14-01092-03  
(Replaces Carrier #: 14-01092-03)



#### Indicator, Sightglass

Order Part #: P-14-00220-00  
(Replaces Carrier #: 14-00220-00)

## CONTAINER Parts

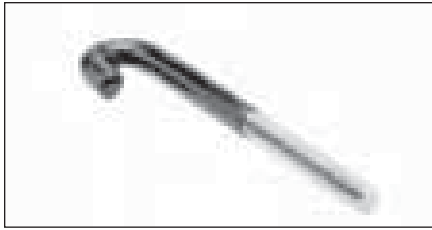

### J-Bolt, Battery

Order Part #: P-34-06058-06  
(Replaces Carrier #: 34-06058-06)

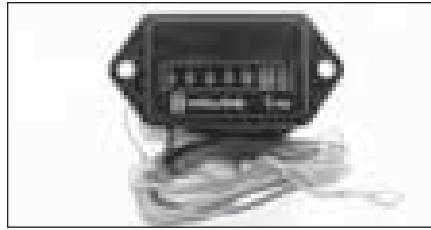

### Meter, Hour, Mini

Order Part #: P-10-00363-00  
(Replaces Carrier #: 10-00363-00)

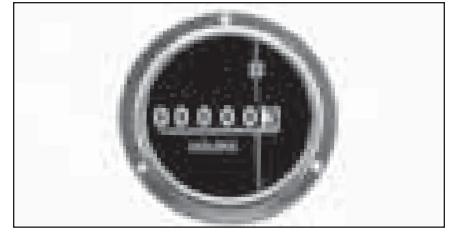

### Meter, Hour

Order Part #: P-66U1-3823  
(Replaces Carrier #: 66U1-3823)



### Meter, Hour

Order Part #: P-10-00363-01  
(Replaces Carrier #: 10-00363-01)

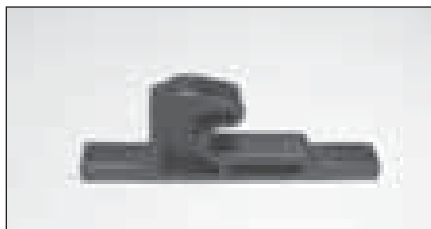

### Keeper, Latch

Order Part #: P-44-00340-03  
(Replaces Carrier #: 44-00340-03)

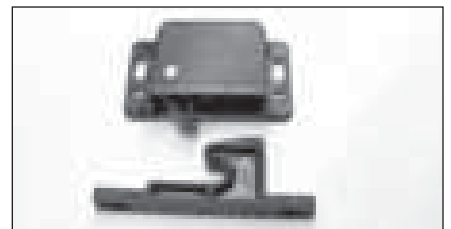

### Latch Kit

Order Part #: P-44-00340-04  
(Replaces Carrier #: 44-00340-04)



### Oil, Comp (Alkylbenzene)

Order Part #: 67-404 (Case of 12)  
66-404 (One Gallon)  
(Replaces Carrier #: 07-00274-00)



### Oil, Comp (Polyolester)

Order Part #: P-07-00317-00  
(Replaces Carrier #: 07-00317-00)



### Pack, Battery

Order Part #: P-30-00407-02SV  
(Replaces Carrier #: 30-00407-02SV)



### Plug, Fusible (3/8F)

Order Part #: P-14-01032-14  
(Replaces Carrier #: 14-01032-14)

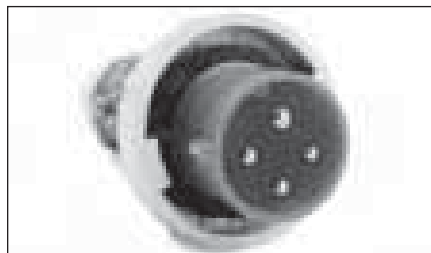

### Plug 32AMP 500V

Order Part #: 41-1976  
(Replaces Carrier #: 22-02378-00)

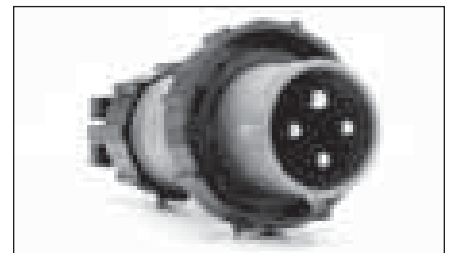

### Plug, Power

Order Part #: P-66U1-3123-1  
(Replaces Carrier #: 66U1-3123-1)

## CONTAINER Parts

### CONTAINER GENERAL PARTS (continued)

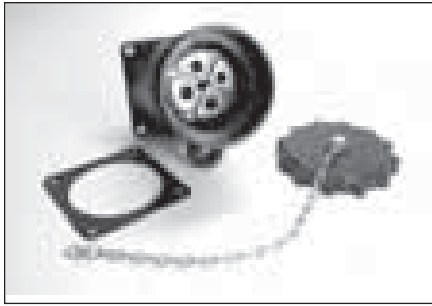

#### Receptacle (60A, 250V)

Order Part #: P-66U1-3863-1  
(Replaces Carrier #: 66U1-3863-1)

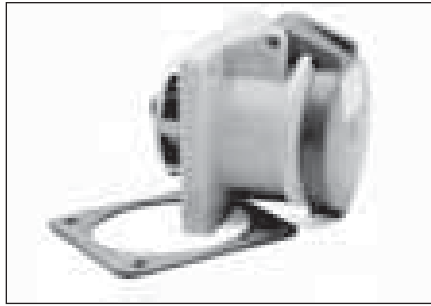

#### Receptacle, Power

Order Part #: P-22-01679-00  
(Replaces Carrier #: 22-01679-00)



#### Receptacle, 5-Pin

Order Part #: 41-2405  
(Replaces Carrier #: 22-01660-03)



#### Recorder Mechanism Assembly

Order Part #: P-09-00147-00  
(Replaces Carrier #: 09-00147-00)



#### Recorder Mechanism Assembly

Order Part #: P-09-00280-00  
(Replaces Carrier #: 09-00280-00)



#### Recorder Mechanism Assembly

Order Part #: P-09-00296-00  
(Replaces Carrier #: 09-00296-00)

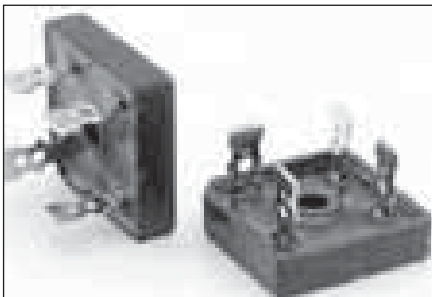

#### Rectifier, Charging System

Order Part #: P-10-01120-00  
(Replaces Carrier #: 10-01120-00)



#### Regulator, Voltage

Order Part #: P-30-00423-02  
(Replaces Carrier #: 30-00423-02)

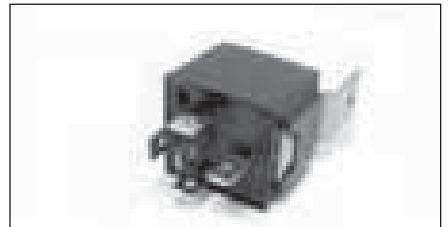

#### Relay

Order Part #: P-10-00286-03  
(Replaces Carrier #: 10-00286-03)

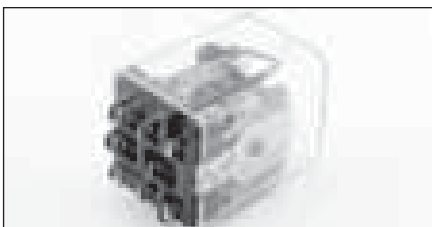

#### Relay, Starter Solenoid (12V)

Order Part #: P-10-00220-00  
(Replaces Carrier #: 10-00220-00)

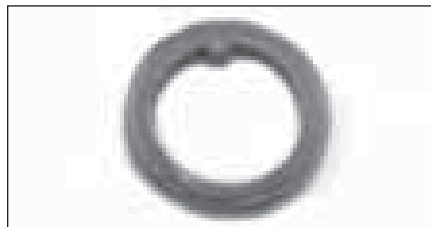

#### Seal, Boot, Switch

Order Part #: P-66U1-9752  
(Replaces Carrier #: 66U1-9752)

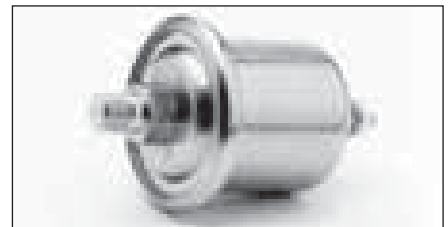

#### Sender, Oil Pressure

Order Part #: P-66U1-2543-2  
(Replaces Carrier #: 66U1-2543-2)

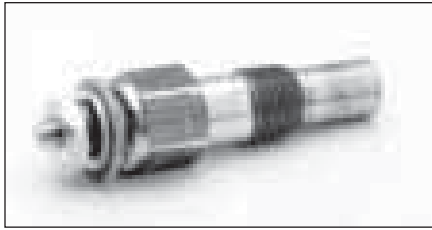
**Sender, Water Temp**

Order Part #: P-12-00098-04  
 (Replaces Carrier #: 12-00098-04)

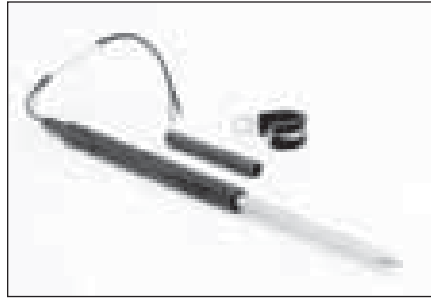
**Sensor, Thermistor (RRS/RTS)**

Order Part #: P-12-00395-01SV  
 (Replaces Carrier #: 12-00395-01SV)

**Sensor, Thermistor (USDA Probe)**

Order Part #: P-12-00342-02  
 (Replaces Carrier #: 12-00342-02)

**Sensor, Thermistor (USDA Probe)**

Order Part #: P-12-00342-03  
 (Replaces Carrier #: 12-00342-03)

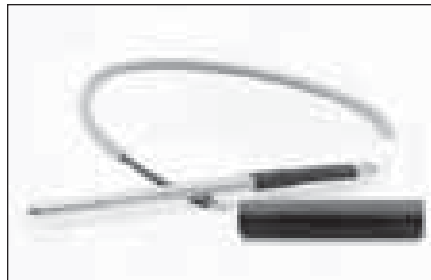
**Sensor, Thermostat**

Order Part #: P-12-01072-11SV  
 (Replaces Carrier #: 12-01072-11SV)

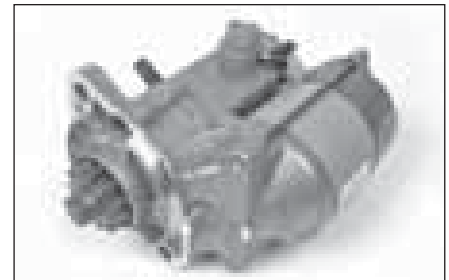
**Starter, 1 pc Oil Pan**

Order Part #: P-25-38750-00  
 (Replaces Carrier #: 25-38750-00)

**Switch**

Order Part #: P-69NT35-438  
 (Replaces Carrier #: 69NT35-438)

**Switch**

Order Part #: P-69NT35-763  
 (Replaces Carrier #: 69NT35-763)

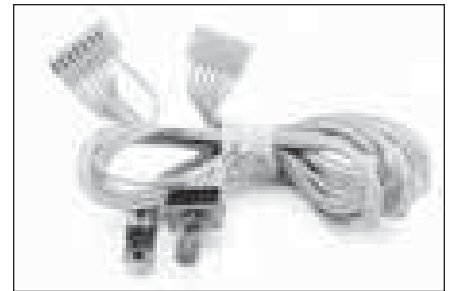
**Switch Assembly (TDS & TSS)**

Order Part #: P-69NT35-963  
 (Replaces Carrier #: 69NT35-963)

**Switch, Pressure (350PSIG, HPS)**

Order Part #: P-12-00309-00  
 (Replaces Carrier #: 12-00309-00)

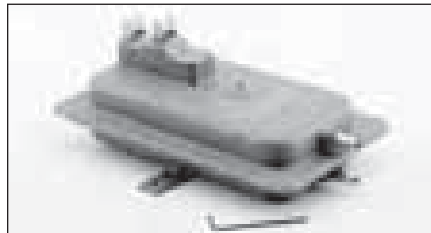
**Switch, Pressure (Air)**

Order Part #: P-66U1-2513  
 (Replaces Carrier #: 66U1-2513)

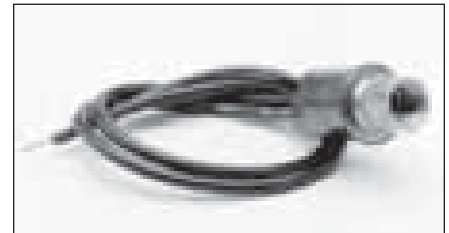
**Switch, Pressure (Water)**

Order Part #: P-12-01071-01SV  
 (Replaces Carrier #: 12-01071-01SV)

## CONTAINER Parts

### CONTAINER GENERAL PARTS (continued)



#### Switch, Push Button (PTS)

Order Part #: P-69NT40-123  
(Replaces Carrier #: 69NT40-123)

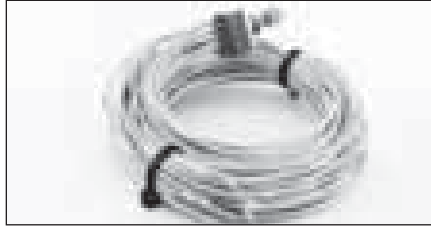

#### Switch, Push Button (TDS)

Order Part #: P-69NT35-926  
(Replaces Carrier #: 69NT35-926)

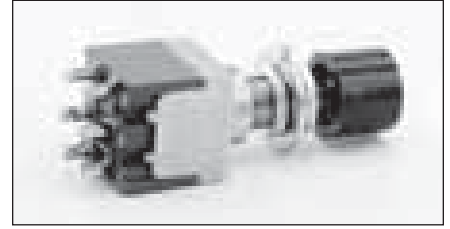

#### Switch, Push Button

Order Part #: P-10-01142-02  
(Replaces Carrier #: 10-01142-02)

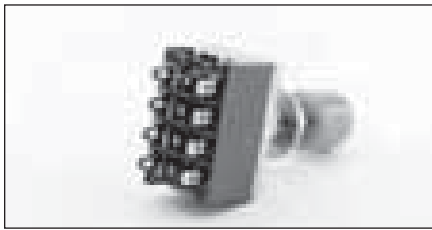

#### Switch, Push Button

Order Part #: P-10-01142-03  
(Replaces Carrier #: 10-01142-03)

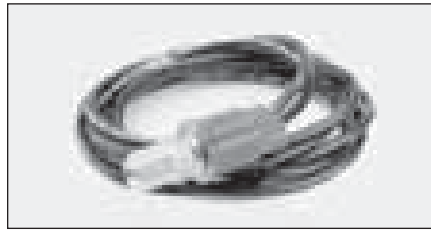

#### Switch, Pressure (HPS)

Order Part #: P-66U1-6942-4  
(Replaces Carrier #: 66U1-6942-4)

#### Switch, Pressure (VHPS)

Order Part #: P-66U1-6942-6  
(Replaces Carrier #: 66U1-6942-6)

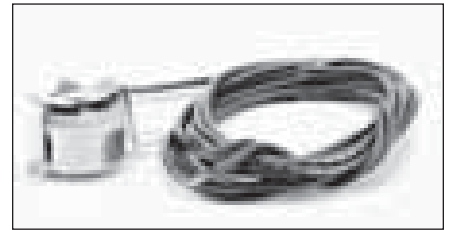

#### Switch, Themostat (DTT)

Order Part #: P-66U1-6912-8  
(Replaces Carrier #: 66U1-6912-8)

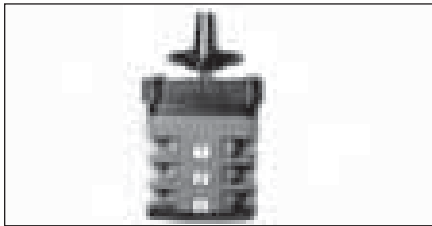

#### Switch, Rotary

Order Part #: P-10-01128-00  
(Replaces Carrier #: 10-01128-00)



#### Switch, Themostat (HTT)

Order Part #: P-66U1-6912-7  
(Replaces Carrier #: 66U1-6912-7)



#### Switch, Toggle (BMS)

Order Part #: P-10-01130-07  
(Replaces Carrier #: 10-01130-07)

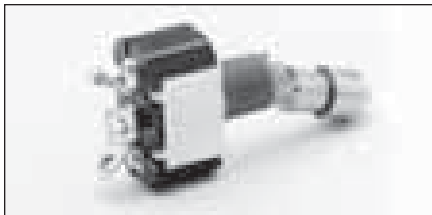

#### Switch, Toggle (Cond. Fan)

Order Part #: P-10-00298-01  
(Replaces Carrier #: 10-00298-01)

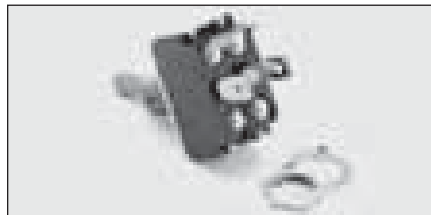

#### Switch, Toggle (GP)

Order Part #: P-10-01129-13  
(Replaces Carrier #: 10-01129-13)



#### Switch, Toggle (IGN)

Order Part #: P-10-00222-00  
(Replaces Carrier #: 10-00222-00)

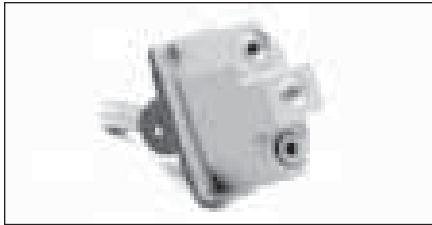

**Switch, Toggle (MDS)**  
 Order Part #: P-10-00221-00  
 (Replaces Carrier #: 10-00221-00)



**Switch, Toggle (MDS)**  
 Order Part #: P-10-01129-10  
 (Replaces Carrier #: 10-01129-10)

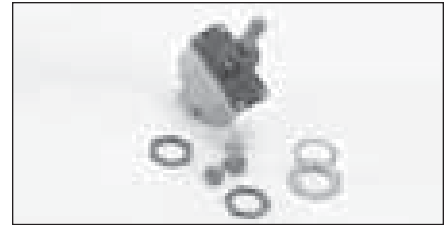

**Switch, Toggle (ON/OFF)**  
 Order Part #: P-10-00237-00  
 (Replaces Carrier #: 10-00237-00)

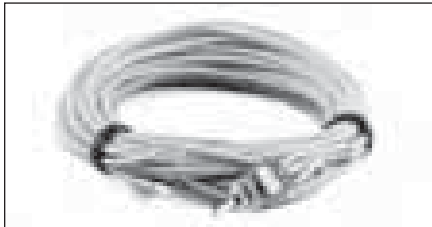

**Switch, Toggle (TSS)**  
 Order Part #: P-69NT35-916  
 (Replaces Carrier #: 69NT35-916)

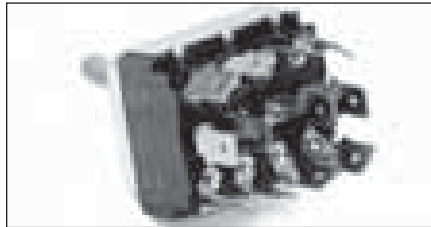

**Switch, Toggle, On/Off (EB)**  
 Order Part #: P-10-01129-07SV  
 (Replaces Carrier #: 10-01129-07SV)

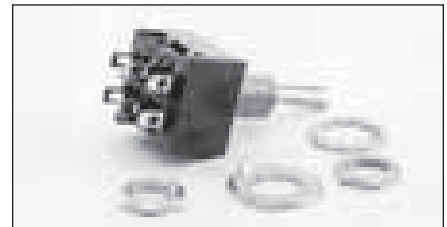

**Switch, Toggle, On/Off (TSS)**  
 Order Part #: P-10-01146-01  
 (Replaces Carrier #: 10-01146-01)

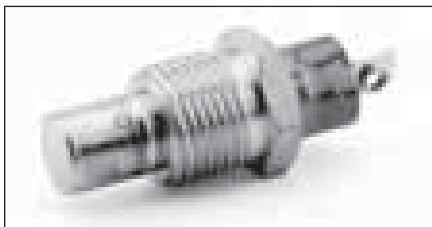

**Switch, Water Temp (110C/230F)**  
 Order Part #: P-10-00158-02  
 (Replaces Carrier #: 10-00158-02)

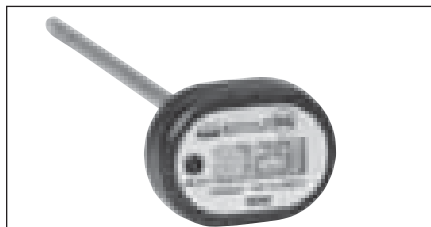

**Thermometer, POCKET Digital(C)**  
 Order Part #: P-300AC  
 (Replaces Carrier #: 300AC)  
**Thermometer, POCKET Digital(F)**  
 Order Part #: P-300A  
 (Replaces Carrier #: 300A)



**Timer, Delay**  
 Order Part #: P-12-01087-00  
 (Replaces Carrier #: 12-01087-00)



**Transducer, Pressure**  
 Order Part #: P-12-00352-00  
 (Replaces Carrier #: 12-00352-00)

**PG Parts offers quality Thermo King parts for your Carrier container, bus, truck and trailer units.**

**Talk to your local Thermo King dealer today about how they can help you with Carrier parts or service.**

**CONTAINER**

## CONTAINER Parts

### CONTAINER GENERAL PARTS (continued)



#### Valve (TXV)

Order Part #: P-14-01104-42  
(Replaces Carrier #: 14-01104-42)



#### Valve (TXV) Less Flange

Order Part #: P-14-01104-03  
(Replaces Carrier #: 14-01104-03)



#### Valve Repair Kit

Order Part #: P-14-50011-01  
(Replaces Carrier #: 14-50011-01)



#### Valve Repair Kit

Order Part #: P-14-50045-00  
(Replaces Carrier #: 14-50045-00)



#### Valve, Pressure (500PSIG)

Order Part #: P-14-00215-03  
(Replaces Carrier #: 14-00215-03)



#### Valve, Pressure Regulator

Order Part #: P-14-00204-02  
(Replaces Carrier #: 14-00204-02)



#### Valve, Service 1-1/8

Order Part #: P-14-01042-06  
(Replaces Carrier #: 14-01042-06)

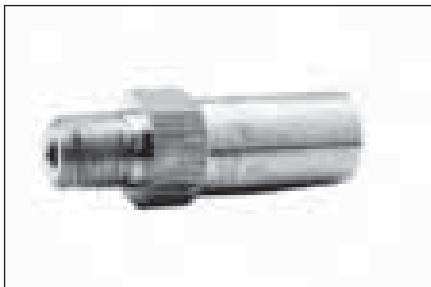

#### Valve, Relief (265 PSIG)

Order Part #: P-14-00195-02  
(Replaces Carrier #: 14-00195-02)



#### Valve, Relief (340 PSIG)

Order Part #: P-14-00195-01  
(Replaces Carrier #: 14-00195-01)

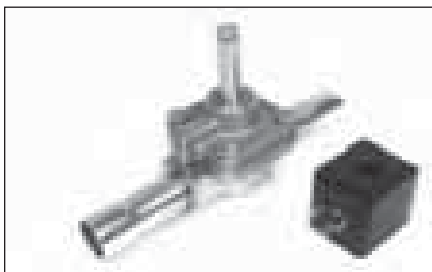

#### Valve, Solenoid

Order Part #: P-14-00230-01SV  
(Replaces Carrier #: 14-00230-01SV)

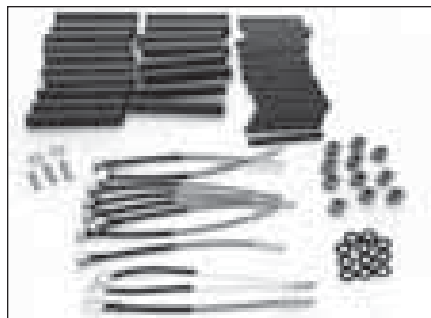

#### Wiring Kit, Compressor

Order Part #: P-76-00384-00  
(Replaces Carrier #: 76-00384-00)



#### Washer

Order Part #: P-34-01226-00  
(Replaces Carrier #: 34-01226-00)

**ALSO AVAILABLE**

## PG Parts Warranty Periods

COMPONENT	DEALER INSTALLED	CUSTOMER INSTALLED
Basic Components or Parts	90 days	90 days
Starter/Alternator (new)	1 year	1 year
Alternator (reman)	9 months	9 months
Compressors (reman)	2 years	2 years
Engines (reman)	2 years	2 years
Microprocessor keypad (reman)	1 year	1 year

### Coverage

- Warranty coverage commences on the date the part is sold by the dealer
- Includes PART ONLY for Aftermarket Parts
- Labor to replace a defective part that fails within the warranty period is at the owner's expense
- Coverage EXCLUDES labor to remove & replace assembly from unit, motor oil, and refrigerant or other miscellaneous or incidental material, parts or labor
- The unexpired portion of the original new unit warranty shall supersede the replacement parts warranty in any case where applicable

The following statement of warranty appears on the reverse side of the customer's copy of the Warranty Registration report for Major Service Parts:

### Manufacturer's Warranty

Subject to the conditions hereinafter stated, Thermo King Corporation ("Thermo King") warrants its parts to be free from defects in material and workmanship for a period of 90 days from the date of original sale by a Thermo King Dealer, unless Thermo King has notified the owner in writing of an extended warranty on a specific part. Such warranty extends only to the original owner of the equipment and is limited to Thermo King's option to repair or replacement with new or remanufactured parts at an authorized Thermo King dealer or service agency of any parts which are found by Thermo King to have been defective under normal use and service within the specified warranty period. Such repair or replacement shall be the owner's exclusive remedy and correction of defects in the above manner shall constitute complete fulfillment of all obligations and liabilities of Thermo King with respect to the parts sold hereunder, whether based in contract, in tort (including negligence and/or strict liability), or otherwise. The decision of Thermo King shall be final and conclusive on any question in connection with the application or scope of this warranty.

### Warranty Services

Any defective part will be repaired or replaced under the terms of this warranty by an authorized Thermo King dealer or service agency without charge to the owner except for labor and incidental expenses, unless Thermo King has notified the owner in writing that certain labor cost are covered. Any part which is replaced shall become property of Thermo King. Such warranty services will be performed by authorized Thermo King dealer or service agency at its premises during regular working hours and will not include overtime, mileage, telephone calls or telegrams, cost of transportation and/or relocation of equipment or personnel, or other incidental expenses. Where repairs under warranty are made outside the United States, the owner will be charged any customs duties and taxes applicable to the parts and labor in accordance with the regulations of the country where such warranty repairs are performed. This certificate when presented to an authorized Thermo King dealer or service agency entitles the original owner to receive the foregoing warranty services. If the registration plate is blank and the owner cannot establish the date in service, the Thermo King dealer or service agency is not authorized to render the warranty services without charge. If a charge is made, the owner must present the defective part and its paid invoice to the Thermo King dealer from whom the part was purchased for validation with Thermo King. The owner should make every effort to receive warranty services from the Thermo King dealer who sold the part. Thermo King's warranty does not include consumable or maintenance items, such as, but not limited to, engine oil, lubricants, fuses, fuel, filters and filter elements, glow plugs, cleaning materials, light bulbs, refrigerant gases, driers and batteries.

### Limitation of Liability

Thermo King's warranty shall not apply to any equipment which (i) has been so installed, maintained, repaired or altered as, in Thermo King's judgment, to affect its integrity, (ii) has been subject to misuse, negligent handling or accident, or (iii) has been operated contrary to Thermo King's printed instructions. Thermo King or any authorized Thermo King dealer or service affiliate shall have the right to require that the owner provide maintenance records to show that the equipment has been properly maintained. THIS WARRANTY IS EXCLUSIVE AND IN LIEU OF ALL OTHER WARRANTIES, EXPRESS OR IMPLIED, INCLUDING ALL WARRANTY OF MERCHANTABILITY AND FITNESS FOR A PARTICULAR PURPOSE AND ALL WARRANTIES ARISING FROM COURSE OF PERFORMANCE OR DEALING OR USAGE OF TRADE, EXCEPT OF THE TITLE AND AGAINST PATENT INFRINGEMENT.

Thermo King shall have no liability in contract or in tort (including negligence or strict liability) or otherwise, for any injury or damage caused to vehicles, content, product cargo or other property or for any special, incidental, indirect or consequential damages whatsoever, including, but not limited to, loss or interruption of business, lost profits and loss of use. The remedies of the owner herein are exclusive and the total cumulative liability of Thermo King shall in no event exceed the purchase price of the part in which such liability is based.

**Carrier Trailer Units**

	ULTIMA	ULTIMA XTC	ULTRA	ULTRA XT	ULTRA XTC	GEN TM900/1000	ADVANTAGE	EXTRA	EXTRA XT
<b>BELTS</b>									
Water Pump	P-50-00162-04	P-50-00162-22	P-50-00162-04	P-50-00162-22	P-50-00162-22	P-50-00162-04	P-50-00162-04	P-50-00162-04	
Alternator	P-50-00179-22	P-50-00162-22	P-50-00162-08 P-50-00179-09 P-50-00179-20 P-50-00178-13	P-50-00162-22	P-50-00162-22	P-50-00179-20	P-50-00179-00	P-50-00179-20	P-50-00162-18
Condenser Fan	P-50-00178-20		P-50-00178-07			P-50-00178-07		P-50-00178-07	
Compressor	P-50-00178-16		P-50-00178-08			P-50-00178-08		P-50-00178-08	P-50-00178-08
Generator			P-50-00178-10						
Lower Drive		P-50-00178-19		P-50-00178-19	P-50-00178-19				
Upper Drive		P-50-00178-26		P-50-00178-24	P-50-00178-24				P-50-00178-24
Drive to J-Shaft							P-50-00178-00		
J-Shaft to F-Shaft							P-50-01161-02 P-50-00183-01		
<b>FILTERS</b>									
Air	P-30-00430-23 P-30-01077-01	P-30-00426-27	P-30-01077-01	P-30-00426-20 P-30-00471-20	P-30-00426-27	P-30-01077-01	P-66U1-2155	P-30-00430-23	P-30-00426-20 P-30-00471-20
Fuel Primary	P-30-01090-05 P-30-01079-01	P-30-01090-05 P-30-01079-01	P-30-01079-01	P-30-01090-05	P-30-01090-05	P-30-01079-01	P-30-50301-01	P-30-01090-05 P-30-01079-01	P-30-01090-05
Fuel Secondary							P-30-00302-00		
Oil	P-30-00323-00		P-30-00323-00	P-30-00450-00	P-30-00463-00 P-30-00450-00	P-30-00323-00	P-30-00323-00	P-30-00323-00	P-30-00450-00
Oil Bypass	P-30-00304-00-B		P-30-00304-00-B			P-30-00304-00-B	P-30-00304-00-B	P-30-00304-00-B	P-30-00304-00-B
<b>MISC PARTS</b>									
Engine	P-26-50015-00RM	P-26-50015-00RM	P-26-50015-00RM P-26-50004-00RM	P-26-50015-00RM	P-26-50015-00RM	P-26-50015-00RM P-26-50004-00RM			
Compressor	P-18-00059-127RM	P-18-00059-127RM	P-18-00059-127RM P-18-00059-126RM	P-18-00059-127RM	P-18-00059-127RM	P-18-00059-127RM P-18-00059-126RM		P-18-00059-126RM	P-18-00059-126RM
Alternator	P-30-00409-10 P-30-00409-10RM	P-30-00409-10 P-30-00409-10RM	P-30-50326-00	P-30-00409-10 P-30-00409-10RM	P-30-00409-10 P-30-00409-10RM	P-30-00409-10 P-30-00409-10RM	P-30-00423-00	P-50-00162-08	P-30-00409-10 P-30-00409-10RM
Clutch	P-50-00228-02SV	P-50-00236-05	P-50-00215-01SV	P-50-00236-05	P-50-00236-05	P-50-00236-05	NA	P-14-00209-00	P-14-00209-00
Drier	P-14-00209-00	P-14-00209-00	P-14-00209-00	P-14-00209-00	P-14-00209-00	P-14-00209-00		P-14-00209-00	P-14-00209-00
Solenoid Fuel	P-25-38109-05SV	P-25-38109-05SV	P-25-38109-05SV	P-25-38109-05SV	P-25-38109-05SV	P-25-38109-05SV		P-14-00209-00	P-25-38109-05SV
Solenoid Speed	P-10-01178-02SV	P-10-01178-02SV	P-10-01178-02SV	P-10-01178-02SV	P-10-01178-02SV	P-10-01178-02SV	P-10-60018-00SV	P-10-01178-02SV	P-10-01178-02SV
Starter	P-25-39291-00-B	P-25-39291-00-B	P-25-39291-00-B	P-25-39291-00-B	P-25-39291-00-B	P-25-39291-00-B	P-25-39291-00-B	P-25-39291-00-B	P-25-39291-00-B
Switch Oil-Press	P-12-00592-00	P-12-00592-00	P-12-00592-00	P-12-00592-00	P-12-00592-00	P-12-00592-00	P-10-00316-00	P-10-00316-00	P-12-00592-00
Switch W-Temp	P-12-00312-03	P-12-01145-03	P-12-00312-03	P-12-00312-03	P-12-01145-03	P-12-00312-03	P-12-00098-04	P-12-00098-04	P-12-00312-03
Switch W-Temp							P-12-00257-00	P-12-00257-00	
Water Pump	P-25-37581-10-B	P-25-37581-10-B	P-25-37581-10-B	P-25-37581-10-B	P-25-37581-10-B	P-25-37581-10-B	P-25-37581-10-B	P-25-37581-10-B	P-25-37581-10-B

## Carrier Truck Units

	Supra 422	Supra 622/644/722/744	Supra 922/944
<b>BELTS</b>			
Water Pump	P-25-34856-00	P-50-60197-04	P-25-33023-00
Alternator	P-50-00179-03	P-50-60006-02	P-50-60006-02
Comp/Elec Motor	P-50-00179-05	P-50-60007-00	P-50-00178-58
Engine to Comp	P-50-60198-44	P-50-00162-53	P-50-01166-00
<b>FILTERS</b>			
Air	NA	NA	P-30-60049-20 P-25-35250-02
Fuel Primary	P-30-01090-05 P-30-01079-01	P-30-01090-05 P-30-01079-01	P-30-01090-05 P-30-01079-01 P-30-00302-00
Oil	P-941172	P-941172	P-30-00323-00
Oil Bypass	P-30-00304-00-B		
<b>MISC PARTS</b>			
Compressor		P-18-60000-04RM	P-18-00059-130RM
Alternator	P-30-00409-10 P-10-00409-10RM	P-30-60050-04	
Clutch	P-50-60029-00-B	P-50-01165-01-B	P-50-50051-04-B
Drier	P-14-01063-03	P-14-00326-00	P-14-00326-00
Fan Motor Evap 12V	P-54-60006-13	P-54-60006-13	P-54-60006-13
Fan Motor Brush 12V	P-54-60006-30PG	P-54-60006-30SV	P-54-60006-30SV
Solenoid Fuel			P-25-15230-01
Solenoid Speed	P-10-60018-00SV	P-10-01179-00	P-10-60018-00SV
Switch Pressure R404A		P-12-00309-04	P-12-00309-04
Switch Pressure R22	P-12-00309-01	P-12-00309-01	
Switch Oil Press	P-12-00592-00	P-12-00592-00	P-12-00592-00
Switch Water Temp	P-12-60000-00	P-12-01145-03	P-12-01145-03
Starter	P-25-34885-00	P-25-35465-00	P-29-70158-00
Water Pump	P-25-34935-00SV	P-25-34330-00SV/B	P-29-70183-00SV/B



























































